

# Elementary Particles II

## 1 – QCD

Color, Gauge Fields, Gluons,  
Asymptotic Freedom, Confinement,  
Perturbative QCD, Quarkonium

# Re-examining the Evidence

2

Experiments probing the EM structure, like DIS:  
Scaling of the structure functions:

Evidence for point-like, charged constituents

Like free particles when interacting with EM currents at high  $Q^2$   
Never observed outside hadrons → Tightly bound?

Experiments probing the strong interaction:  
Large particle zoo

Evidence for highly symmetrical grouping and ordering

Strong suggestion of a substructure: Quarks  
Funny, ad-hoc rules driving the observed symmetry

# Constituents?

3

Besides the general, puzzling behavior observed, finally identify a number of serious problems, cast into a few issues:

*Baryons and the Pauli Principle*

*R Ratio*

*$\pi^0$  Decay Rate*

*$\tau$  Lepton Branching Ratios*

From all these questions a common conclusion:

*Our picture of the quark model is not complete*

# Pauli Principle

4

Quark model:

Besides its many, remarkable successes, a central point is at issue:

*The baryon wave function (space  $\times$  spin  $\times$  flavor) is symmetric*

Pauli Principle seems to be lost, which is very bad news:

The Spin-Statistics Theorem is a consequence of very general principles of relativistic QFT, not easily dismissed



# R Ratio - I

5

Assume the process  $e^+e^- \rightarrow \text{hadrons}$  to proceed at the lowest order through  
 $e^+e^- \rightarrow q\bar{q} \rightarrow \text{hadrons}$

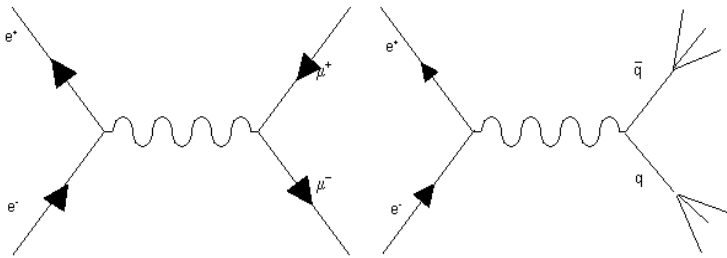

As for DIS:  
 Don't care about quark *hadronization*, assume  
 the time scales for hard and soft sub-processes  
 to be wildly different

$$\sigma(e^+e^- \rightarrow \mu^+\mu^-) = \frac{4\pi\alpha^2}{3s}$$

$$\sigma(e^+e^- \rightarrow q\bar{q}) = \frac{4\pi\alpha^2 Q_q^2}{3s}, \quad Q_q = \text{quark charge in } e \text{ units}$$

$$R(E_{CM}) = \frac{\sigma(e^+e^- \rightarrow \text{adroni})}{\sigma(e^+e^- \rightarrow \mu^+\mu^-)} = \frac{\sum_q \sigma(e^+e^- \rightarrow q\bar{q})}{\sigma(e^+e^- \rightarrow \mu^+\mu^-)} = \sum_q Q_q^2$$

Sum extended to all accessible  
 quark flavors  $\rightarrow 2m_q < E_{CM}$

# R Ratio - II

6

$R$  counts the number of different quark species created at any given  $E_{CM}$ . Expect:

$$u, d \rightarrow R = \left(\frac{2}{3}\right)^2 + \left(-\frac{1}{3}\right)^2 = \frac{5}{9}$$

*Low energy*

$$u, d, s \rightarrow R = \left(\frac{2}{3}\right)^2 + \left(-\frac{1}{3}\right)^2 + \left(-\frac{1}{3}\right)^2 = \frac{6}{9}$$

$E > 1-1.5 \text{ GeV}$

$$u, d, s, c \rightarrow R = \left(\frac{2}{3}\right)^2 + \left(-\frac{1}{3}\right)^2 + \left(-\frac{1}{3}\right)^2 + \left(\frac{2}{3}\right)^2 = \frac{10}{9}$$

$E > 3 \text{ GeV}$

By taking 3 quark species  
of any flavor:

$$u, d \rightarrow R = \frac{15}{9}$$

$$u, d, s \rightarrow R = \frac{18}{9}$$

$$u, d, s, c \rightarrow R = \frac{30}{9}$$

# R Ratio - III

7

$$R = \sigma(\text{hadrons}) / \sigma(\mu^+ \mu^-)$$

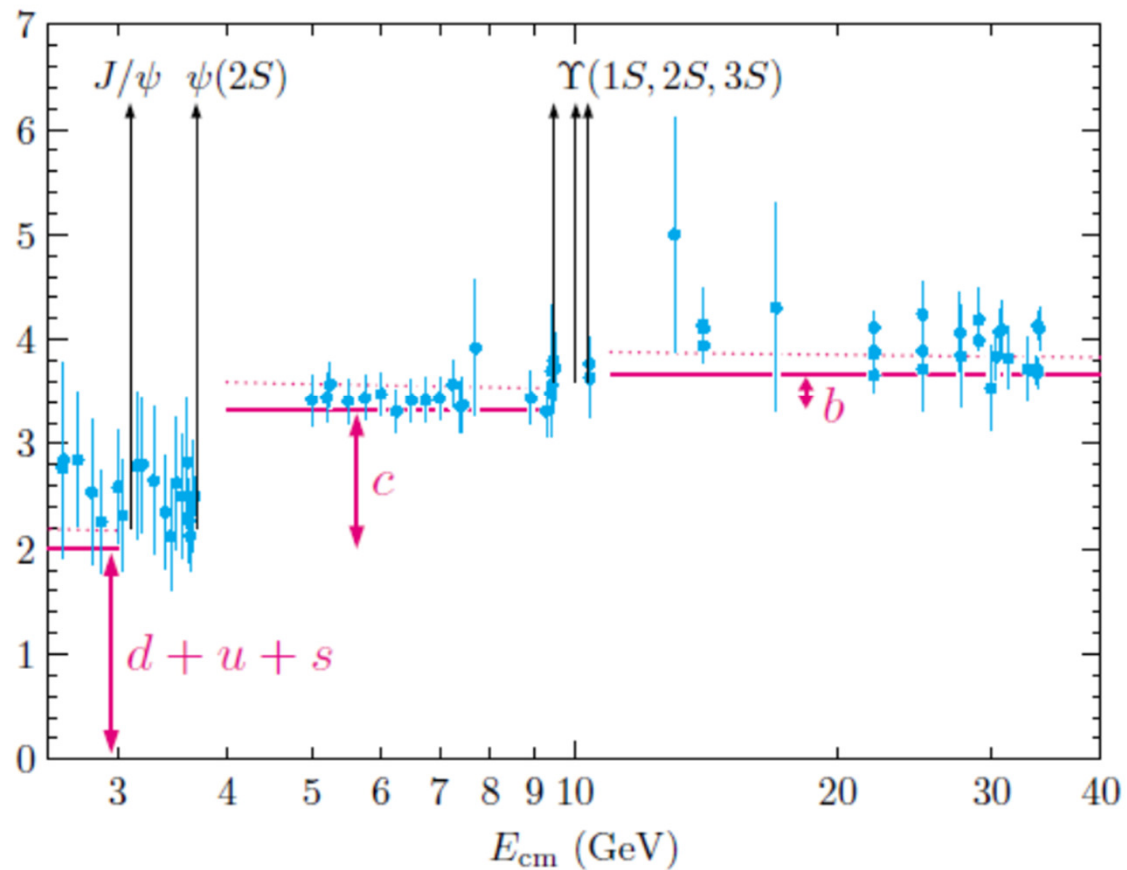

@TBA

# $\pi^0$ Decay Rate - I

8

Originally calculated by taking  $p, \bar{p}$  in the triangle loop (Steinberger 1949)

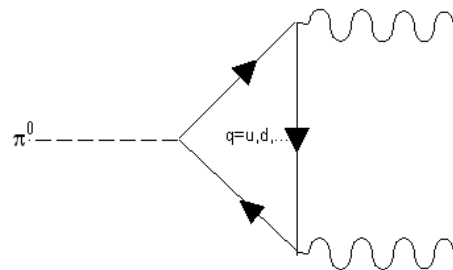

Steinberger's calculation:

Yukawa model to account for  $\pi pp$  vertex

Point-like nucleons  $\rightarrow$  QED couplings to photons

Nucleon current in the loop: 4-vector  $J^\mu$

[Actually *axial* vector, to match pion -ve parity]

$\pi^0$  spinless: Only 4-vector available  $p_\mu$

$\rightarrow$  Decay amplitude  $\sim p_\mu J^\mu$

# $\pi^0$ Decay Rate - II

9

With a proton loop rate OK (!)

By naively replacing the proton loop by a quark loop:

$$J^\mu \approx \sum_{i=u}^d q_i \bar{\psi}_i \gamma^\mu \gamma^5 \psi_i = e \left( \frac{2}{3} \bar{u} \gamma^\mu \gamma^5 u - \frac{1}{3} \bar{d} \gamma^\mu \gamma^5 d \right)$$

Amplitude: 2 vertexes

Each vertex  $\propto \sqrt{\alpha} = e \rightarrow$  Amplitude  $\propto e^2$

Sum over light quarks  $u, d$ :

$$\sum_{i=u,d} a_i Q_i^2 = e^2 \left[ 1 \cdot \left( \frac{2}{3} \right)^2 - 1 \cdot \left( -\frac{1}{3} \right)^2 \right] = e^2 \left[ \frac{4}{9} - \frac{1}{9} \right] = e^2 \frac{1}{3}$$

$$\Gamma_{quark}(\pi^0 \rightarrow \gamma\gamma) = \frac{1}{9} \Gamma_{proton}(\pi^0 \rightarrow \gamma\gamma) \quad ???$$

$\rightarrow$  Wrong by a factor 9!

Bad news for the quark model

# $\pi^0$ Decay Rate - III

10

Upon looking more carefully to the problem, things look actually even worse:

By taking seriously the quark model, one cannot escape consequences of approximate *chiral symmetry* of light quarks

Then simple guess on approximate symmetry of the initial state would lead to conclude *the neutral pion is stable!* Another quark model puzzle..

Explanation of this paradox led to discovery of the first *anomaly* in QFT (Adler, Bell & Jackiw) : Actually related to a wrong integral...

Advanced topic, quite relevant to the Standard Model:  
Quantum field theories must be *anomaly free* in order to be renormalizable

Interesting conditions for SM to be anomaly free, including *charge quantization*

# $\pi^0$ Decay Rate - IV

11

Direct method:

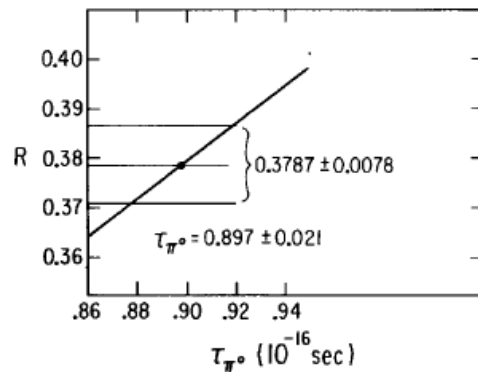
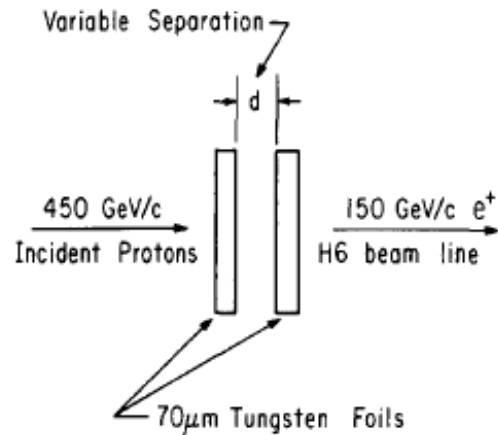

$\pi^0$  produced in a first thin foil, when not decayed do not contribute to  $e^+$  yield from  $\gamma$  conversion in a second thin foil

$$Y(d) = N \{ A + B [1 - \exp(-d/\lambda)] \}$$

$$\lambda = \beta \gamma c \tau \simeq \gamma c \tau \quad \text{Energy dependent}$$

Use known energy spectra for pions

@TBA

$$\tau = 0.897 \pm .021 \cdot 10^{-16} \text{ s}$$

$$\Gamma = 7.34 \pm 0.18 \pm 0.11 \text{ eV}$$

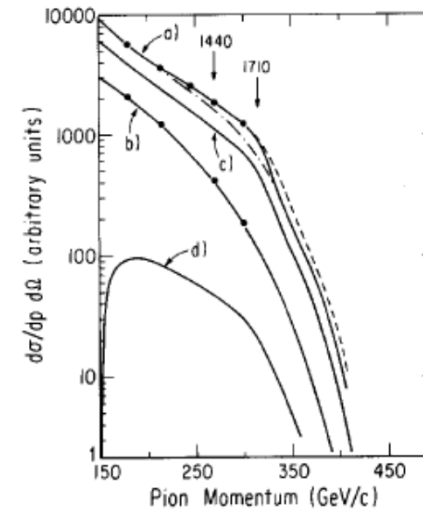

# $\pi^0$ Decay Rate - V

12

## Primakoff effect

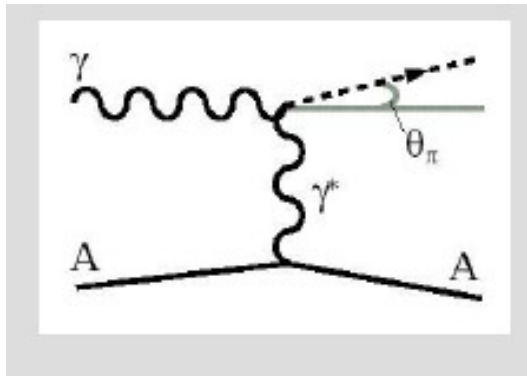

@TBA

Very simple idea:

Get a high energy photon beam + high Z target

Pick-up a virtual photon from the nuclear Coulomb field

2-photon coupling will (sometimes) create a  $\pi^0$

$$\frac{d\sigma_{\text{Prim}}}{d\Omega_{\text{LAB}}} \simeq \Gamma_{\pi^0 \rightarrow \gamma\gamma} Z^2 \frac{8\alpha E^4}{m_{\pi^0}^2} \frac{|F(q^2)|^2}{q^4} \sin^2 \theta_{\pi^0}$$

Strongly forward peaked

Quickly increasing with energy

Strongly Z dependent: Coherence

$\Gamma = 1/\tau$  extracted by measuring the differential cross-section

Nuclear form factor required



# $\pi^0$ Decay Rate - VI

13

Recent experiment: PrimEx at Jefferson Lab (Virginia)

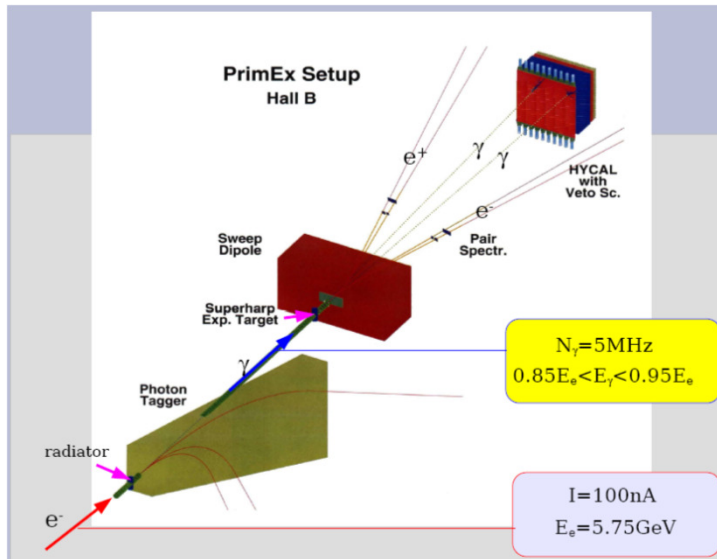

@TBA

## Tagging Technique

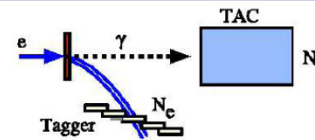

$$N_\gamma^{\text{tag}} = N_e^{\text{tag}} \cdot \epsilon_{\text{tag}}$$

$N_\gamma^{\text{tag}}$  : Number of Tagged Photon  
 $N_e^{\text{tag}}$  : Number of Tagged Electron  
 $\epsilon^{\text{tag}}$  : Tagging Efficiency

- $N_\gamma = N_{e'} \cdot \epsilon_{\text{tag}}$
- $E_\gamma = E_e - E_{e'}$   
 $(\Delta E_\gamma / E_\gamma \sim 10^{-3})$

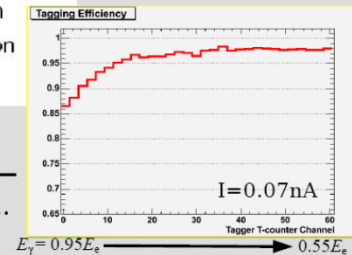
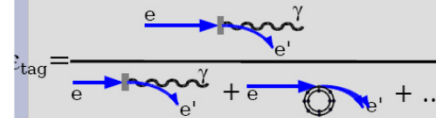

# $\tau$ Lepton Decays

14

$\tau$ : Heavy brother of  $e$  and  $\mu$

$m_\tau = 1776$  MeV

Weak decays:

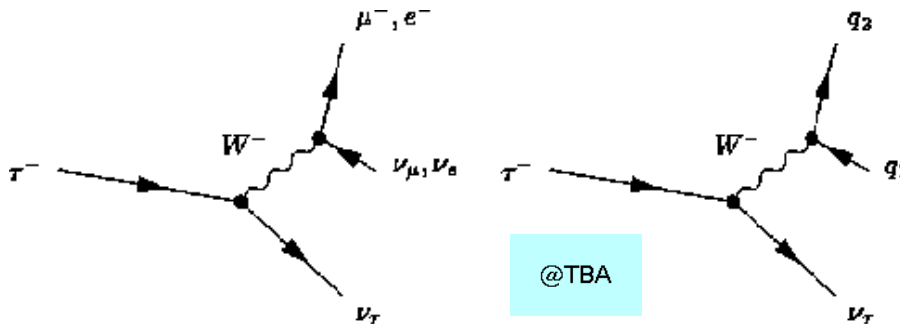

$q, \bar{q} : u, d, s$

$BR(e) \sim 18\%$

$BR(\mu) \sim 17\%$

$BR(q\bar{q}) \sim 65\%$

In the absence of color, weak interaction universality would lead to predict:

$$BR(e) \sim BR(\mu) \sim BR(q\bar{q}) \sim 33\%$$

With color:

$$\Gamma(q\bar{q}) \sim 3 \Gamma(l\bar{l}) \rightarrow BR(q\bar{q}) \sim \frac{3 \Gamma(l\bar{l})}{3 \Gamma(l\bar{l}) + 2 \Gamma(l\bar{l})} \sim 60\% \text{ OK}$$

# Color - I

15

New hypothesis:

*There is a new degree of freedom for quarks: Color*

Each quark can be found in one of 3 different states  
Internal space (mathematically identical to flavor):

States = 3-component complex vectors

Base states:

$$R(ed) = \begin{pmatrix} 1 \\ 0 \\ 0 \end{pmatrix}, G reen) = \begin{pmatrix} 0 \\ 1 \\ 0 \end{pmatrix}, B(lue) = \begin{pmatrix} 0 \\ 0 \\ 1 \end{pmatrix}$$

Needless to say, nothing to do with our old, beloved color concept (nature, art, politics..):

Just a *name* for another, non-classical property of hadron constituents

# Color - II

16

Provided one can build a color wave function for 3 fermions which is antisymmetric, the Fermi statistics problem is solved

Total wave function of a baryon

$$\psi = \psi_{color} \underbrace{\psi_{orbital} \psi_{spin} \psi_{flavor}}_{\text{Symmetric}} \rightarrow \psi_{color}: \text{Antisymmetric}$$

To account for 3 different color states, the  $R$  ratio must be multiplied by 3  $\rightarrow$  OK with experimental data

Just the same conclusion for hadronic  $\tau$  decays: Multiply rate by 3

The correct  $\pi^0$  rate is obtained by inserting a factor 9

# Color - III

17

Observe:

When computing  $R$ ,  $\tau$  decay rates we add the *rates* for different colors

→Factor  $\times 3$

*We deal with quarks as with real, on-shell particles: Ignore fragmentation*

When computing  $\pi^0$  decay rate, we add the *amplitudes*

→Factor  $\times 9$

Quarks in the loop are virtual particles: *Amplitudes interfere*

# Color - IV

18

Must be possible to build hadron states as color *singlets*

Do not expect hadrons to fill larger irr.reps.:

Would imply large degeneracies for hadron states, not observed

In other words:

*Color is fine, but we do not observe any colored hadron*

Therefore we assume the color charge is *confined*:

Never observed directly, as it is the electric charge

Why? For the moment, nobody really knows

# Color - V

19

How colored hadrons would show up?  
Just as an example:

Should the nucleon fill the  $\mathbf{3}$  of  $SU(3)_C$ , there would be 3 different species of protons and neutrons.

Then each nucleon level in any nucleus could accommodate 3 particles instead of one:

*The nuclear level scheme would be far different from the observed one*

# Color - VI

20

Guess  $SU(3)$  as the color group  
Take the two fundamental decompositions:

$$\mathbf{3} \otimes \mathbf{3} \otimes \mathbf{3} = \mathbf{1} \oplus \mathbf{8} \oplus \mathbf{8} \oplus \mathbf{10} \quad \text{Baryons}$$

$$\mathbf{3} \otimes \mathbf{3}^* = \mathbf{1} \oplus \mathbf{8} \quad \text{Mesons}$$

Both feature a singlet in the direct sum: OK  
No singlets in  $\mathbf{3} \otimes \mathbf{3}$ : OK

Can't say the same for other groups...

Take  $SU(2)$  as an example:

Say the quarks live in the adjoint  $SU(2)$  representation,  $\mathbf{3}$

Then for  $qq$

$$\mathbf{3} \otimes \mathbf{3} = \mathbf{1} \oplus \mathbf{3} \oplus \mathbf{5}$$

Observe: This is  $\mathbf{3}$  of  $SU(2)$ , which is quite different from  $\mathbf{3}$  of  $SU(3)$

Diquarks can be in color singlet

→Should find diquarks as commonly as baryons or mesons..



# Colored Quarks

21

$$I_3^c = \frac{\lambda_3}{2}, \quad Y^c = \frac{\lambda_8}{\sqrt{3}}$$

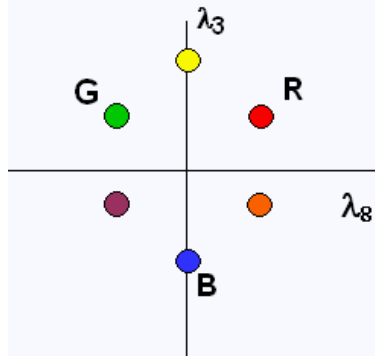

	$I_3^c$	$Y^c$		$I_3^c$	$Y^c$
$R$	$+1/2$	$+1/3$	$\bar{R}$	$-1/2$	$-1/3$
$G$	$-1/2$	$+1/3$	$\bar{G}$	$+1/2$	$-1/3$
$B$	$0$	$-2/3$	$\bar{B}$	$0$	$+2/3$

$SU(3)_C$  is an *exact symmetry*:

$$m_u^{(R)} = m_u^{(G)} = m_u^{(B)}, \dots$$

*Beware:*  $SU(3)_C$  has nothing to do with  $SU(3)_F$ :

Quark quantum numbers are independent from their color state

They are left unchanged by QCD transitions

# Uncolored Hadrons

22

According to our fundamental hypothesis:

$$\text{Mesons: } \mathbf{3} \otimes \mathbf{3}^* = \mathbf{1} \oplus \mathbf{8}$$

$$\rightarrow \psi_c = \frac{1}{\sqrt{3}}(R\bar{R} + G\bar{G} + B\bar{B})$$

$$\text{Baryons: } \mathbf{3} \otimes \mathbf{3} \otimes \mathbf{3} = \mathbf{1} \oplus \mathbf{8} \oplus \mathbf{8} \oplus \mathbf{10}$$

$$\rightarrow \psi_c = \frac{1}{\sqrt{6}}(RGB - RBG + GBR - GRB + BRG - BGR)$$

In both cases, pick singlet

Mesons: *No particular exchange symmetry*  
(2 non identical particles)

Baryons: *Fully antisymmetrical color wave function*  
(3 identical particles)

# Color Interaction: QCD

23

Color: A new degree of freedom for quarks  
Compare to other quantum numbers:

Baryonic/Leptonic numbers  
Conserved, *not originating interactions*

Electric charge  
Conserved, *origin of the electromagnetic field*

A deep question:

*What is the true origin of the electromagnetic interaction?*

We have freely used the interaction term  $j^\mu A_\mu$ , only based on the classical analogy:  
But supposedly quantum mechanics is more general than classical mechanics/electromagnetism..

Is there any deeper origin for it?

# QED as a Gauge Theory - I

24

Symmetry:

Absolute phase not defined for a wave function.

Expect invariance as per our old acquaintance, Noether's Theorem

$$L_0 = \bar{\psi}(x)(i\gamma^\mu \partial_\mu - m)\psi(x) \quad \text{Free Dirac Lagrangian}$$

Global gauge (=Phase) transformation:

$$G: \psi(x) \rightarrow \psi'(x) = U_\theta \psi(x) = e^{-iq\theta} \psi(x) \quad q\theta: \text{New phase} \propto \text{Charge}$$

$\rightarrow L_0$  invariant wrt  $G \rightarrow$  Charge conservation

Just meaning:

Take *all* particle states, re-phase each state proportionally to its charge

# QED as a Gauge Theory - II

25

Generalize to local phase transformation:

$G_L : \psi(x) \rightarrow \psi'(x) = U_\theta \psi(x) = e^{-iq\theta(x)} \psi(x)$  Local gauge transformation

$\rightarrow L_0$  not invariant wrt  $G_L$ : Derivative term troublesome

$$L_0 = \bar{\psi}(x) (i\gamma^\mu \partial_\mu - m) \psi(x) \rightarrow L_0' = i\bar{\psi}(x) e^{+iq\theta(x)} \gamma^\mu \partial_\mu (e^{-iq\theta(x)} \psi(x)) - m\bar{\psi}(x) \psi(x)$$

$$L_0' = i[\bar{\psi}(x) \gamma^\mu \partial_\mu \psi(x) - iq\partial_\mu [\theta(x)] \psi(x)] - m\bar{\psi}(x) \psi(x)$$

$$L_0' = \{i\bar{\psi}(x) \gamma^\mu \partial_\mu \psi(x) + q\partial_\mu [\theta(x)] \psi(x) - m\bar{\psi}(x) \psi(x)\}$$

$$L_0' = [i\bar{\psi}(x) \gamma^\mu \partial_\mu \psi(x) - m\bar{\psi}(x) \psi(x)] + q\partial_\mu [\theta(x)] \psi(x) \neq L_0$$

$\rightarrow$  Local gauge invariance cannot hold in a world of free particles

Symmetry requires interaction

# QED as a Gauge Theory - III

26

New transformation rule:

$$\begin{cases} \psi(x) \rightarrow \psi'(x) = U_\theta \psi(x) = e^{-iq\theta(x)} \psi(x) & \text{As before} \\ A_\mu(x) \rightarrow A_\mu(x) + q \partial_\mu \theta(x) & \text{New character in the comedy} \end{cases}$$

Equivalent to re-define derivative for  $\psi$ :

$$\partial_\mu \rightarrow \partial_\mu + iqA_\mu \quad \text{Vector field}$$

Add a new term to Lagrangian:

$$L_i = - \frac{q \bar{\psi}(x) \gamma^\mu \psi(x) A_\mu}{j^\mu} \quad \text{Interaction term}$$

Same as classical electrodynamics

$$L_0 = \bar{\psi}(x) (i\gamma^\mu \partial_\mu - m) \psi(x) \rightarrow L_0 + L_i = \bar{\psi}(x) (i\gamma^\mu \partial_\mu - m) \psi(x) - q \bar{\psi}(x) \gamma^\mu \psi(x) A_\mu$$

Sum is invariant

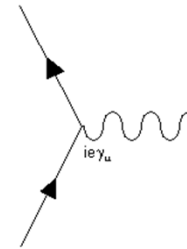

# QED as a Gauge Theory - IV

27

...And another one:

$$-\frac{1}{4}F^{\mu\nu}F_{\mu\nu}, \quad F^{\mu\nu} = \partial^\mu A^\nu - \partial^\nu A^\mu \quad \text{Field energy}$$

Must be there because the field carries energy+momentum+angular momentum

Reminder:

$F^{\mu\nu}$  is the EM field

$$F^{\mu\nu} = \begin{pmatrix} 0 & -E_x & -E_y & -E_z \\ E_x & 0 & -B_z & B_y \\ E_y & B_z & 0 & -B_x \\ E_z & -B_y & B_x & 0 \end{pmatrix}$$

Field must be massless to have  $L$  gauge invariant

$$\frac{1}{2}m^2 A_\mu^2 \rightarrow \frac{1}{2}m^2 (A_\mu(x) + q \partial_\mu \theta(x))^2 \neq \frac{1}{2}m^2 A_\mu^2 \quad \text{if } m \neq 0$$

# QED as a Gauge Theory - V

28

Consider all the phase transformations as defined before:

$$\psi(x) \rightarrow \psi'(x) = U_\theta \psi(x) = e^{-iq\theta(x)} \psi(x)$$

The full set is a group:  $U(1)$  Unitary, 1-dimensional

$$e^{-iq\theta_1(x)} e^{-iq\theta_2(x)} \psi(x) = e^{-iq[\theta_1(x)+\theta_2(x)]} \psi(x) \in U(1)$$

1 parameter:  $\theta(x)$

$$\text{Abelian: } e^{-iq\theta_1(x)} e^{-iq\theta_2(x)} \psi(x) = e^{-iq\theta_2(x)} e^{-iq\theta_1(x)} \psi(x)$$

$U(1)$  is the (Abelian) *gauge group* of QED

Equivalent to  $SO(2)$ , group of 2D rotations



# QCD as a Gauge Theory - I

29

Extend gauge transformations to a 3-component wave function:

$$\Psi \equiv \begin{pmatrix} \psi_R \\ \psi_G \\ \psi_B \end{pmatrix}$$

Global gauge transformation: Phase change for individual components

→ Phase change will mix color components

$$G_G^C : \Psi(x) \rightarrow \Psi'(x) = \mathbf{U}_G \cdot \Psi(x) = e^{-ig\mathbf{M}} \cdot \Psi(x) \quad \mathbf{U}_G \text{ unitary} \rightarrow \mathbf{M} \text{ Hermitian}$$

$$e^{-ig\mathbf{M}} = \mathbf{1} - ig\mathbf{M} + \frac{(-ig\mathbf{M})^2}{2!} + \dots \quad \mathbf{M}: 3 \times 3 \text{ Hermitian matrix}$$

$\mathbf{M}$  acting on the 3 color components of the quark state

Since the color symmetry group is  $SU(3)_C$ :

$$\mathbf{M} = \sum_{i=1}^8 \lambda_i \theta_i \equiv \vec{\lambda} \cdot \vec{\theta}$$

$\vec{\lambda}$ : Vector of 8  $3 \times 3$  Gell-Mann matrices;  $\vec{\theta}$ : Vector of 8 parameters

# QCD as a Gauge Theory - II

30

As for QED, extend to *local* gauge transformations

As before, in order to guarantee invariance of  $L$ :

→ Re-define derivative adding new vector fields:

$$\partial_\mu \rightarrow \partial_\mu \mathbf{1} + ig\mathbf{C}_\mu$$

$$\mathbf{C}_\mu : \begin{cases} \text{4-vector field} & \text{Lorentz structure} \\ \text{Matrix} \in SU(3)_C & \text{Color space} \end{cases}$$

We know how to express any Hermitian matrix  $\in SU(3)_C$ :

Use  $SU(3)_C$  generators → Gell-Mann matrices

$$\rightarrow \mathbf{C}_\mu = \frac{1}{2} \sum_{a=1}^8 G_\mu^a \boldsymbol{\lambda}_a \equiv \vec{G}_\mu \cdot \vec{\boldsymbol{\lambda}} \quad \text{8 fields required: Gluons}$$

So gluons are a bit like 8 different “photons”, exchanged between color charges

But: *They are non Abelian*

# QCD as a Gauge Theory - III

31

Local gauge transformation for  $SU(3)_c$  :

$$\begin{cases} \Psi(x) \rightarrow \Psi'(x) = U_\theta \Psi(x) = e^{-ig\vec{\lambda}\cdot\vec{\theta}(x)} \Psi(x) \\ G_\mu^a(x) \rightarrow G_\mu^a{}'(x) = G_\mu^a(x) + \partial_\mu \theta^a + g \sum_{b,c=1}^8 f^{abc} G_\mu^b(x) \theta^c(x) \end{cases} \quad \begin{array}{l} \text{Very important: New term, coming from } SU(3) \\ \text{being non Abelian} \end{array}$$

Reminder:

$$\left[ \frac{\lambda_a}{2}, \frac{\lambda_b}{2} \right] = if^{abc} \frac{\lambda_c}{2} \quad f^{abc}: SU(3) \text{ structure constants}$$

$$L_0 = \bar{\Psi}(x)(i\gamma^\mu \partial_\mu - m)\Psi(x) \rightarrow L_0 + L_i$$

$$L_i = -g \underbrace{\left[ \bar{\Psi}(x) \gamma^\mu \left( \frac{\vec{\lambda}}{2} \right) \Psi(x) \right]}_{\vec{j}_\mu} \cdot \vec{G}_\mu \quad \text{Interaction term}$$

$$-\frac{1}{4} \vec{G}_{\mu\nu} \cdot \vec{G}^{\mu\nu} = -\frac{1}{4} \sum_{a=1}^8 G_{\mu\nu}^a \cdot G^{a\mu\nu} \quad \text{Field energy term}$$

# QCD as a Gauge Theory - IV

32

Take the expression of fields in terms of potentials:

$$G_{\mu\nu}^a = \partial_\mu G_\nu^a - \partial_\nu G_\mu^a - g \sum_{b,c=1}^8 f_{abc} G_\mu^b G_\nu^c$$

Very important: *Absent in QED* ( $f=0$ )  
New term, coming from  $SU(3)$  being non Abelian

$$\rightarrow G_{\mu\nu}^a G_{\mu\nu}^a \text{ contains terms with } \underbrace{\partial_\mu G_\nu^a \cdot G_\mu^b G_\nu^c}_{3 \text{ gluons}}, \underbrace{G_\mu^b G_\nu^c \cdot G_\mu^b G_\nu^c}_{4 \text{ gluons}}$$

When translated into Feynman rules/diagrams, these pieces of  $L$  correspond to 3 and 4 gluons vertices

So:

The form of QCD Lagrangian leads to predict the existence of a new kind of *gluon-gluon color interaction*

# QCD as a Gauge Theory - V

33

Since color interaction is tied to color charge, we are saying *the gluons carry their own color charge*

Sounds unfamiliar? Well, that's all after playing with a non-Abelian gauge group.

Unlike the electric charge, color charge can manifest itself in more than one way.

Indeed, gluons carry a type of color charge different from quarks/antiquarks:

*Color + Anticolor*

# QCD as a Gauge Theory - VI

34

## QCD Vertices

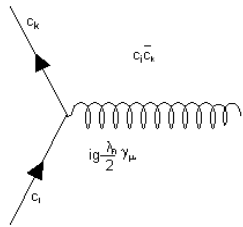

$ig \frac{\lambda_a}{2} \gamma_\mu$  Similar to QED:

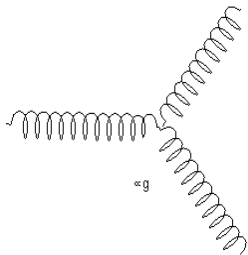
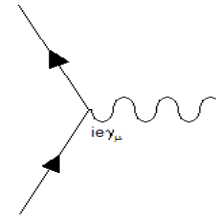

$\propto g$  (Lorentz structure not shown)

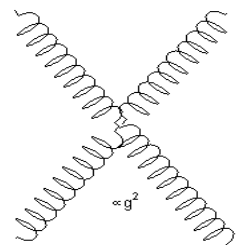

$\propto g^2$  (Lorentz structure not shown)

# Colored Gluons - I

35

Compare to mesons in  $SU(3)_F$ : *Flavor + Antiflavor*  
But: *Gluons are not bound states of Color+Anticolor!*

Still, they share the same math:

Gluons live in the adjoint (8) irr.rep. of  $SU(3)_C$

$$|1\rangle = \frac{1}{\sqrt{2}}(r\bar{b} + b\bar{r}), |2\rangle = -\frac{i}{\sqrt{2}}(r\bar{b} - b\bar{r}), |3\rangle = \frac{1}{\sqrt{2}}(r\bar{r} - b\bar{b})$$

$$|4\rangle = \frac{1}{\sqrt{2}}(r\bar{g} + g\bar{r}), |5\rangle = -\frac{i}{\sqrt{2}}(r\bar{g} - g\bar{r}), |6\rangle = \frac{1}{\sqrt{2}}(b\bar{g} + g\bar{b})$$

$$|7\rangle = -\frac{i}{\sqrt{2}}(b\bar{g} - g\bar{b}), |8\rangle = \frac{1}{\sqrt{6}}(r\bar{r} + b\bar{b} - 2g\bar{g})$$

# Colored Gluons - II

36

A very natural question: Gluons couple to  $q\bar{q}$

Since one can decompose the total  $q\bar{q}$  color state as:

$$\mathbf{3} \otimes \mathbf{3}^* = \mathbf{1} \oplus \mathbf{8}$$

Then: Where is the singlet gluon?

Does not exist: There are only 8 gluons, not 9

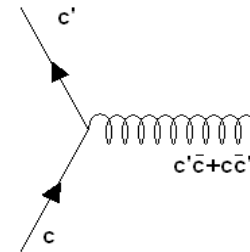

Should the singlet gluon actually exist, it would behave more or less like a “photon”:

*Would be ‘white’ (= Singlet)*

*Would couple to color charges in the same way as photon couples to electric charges*

*Would give rise to a sort of “QED-like”, long range color interaction, not observed*



# Colored Gluons - III

37

Non Abelian vertices: Gluon-Gluon scattering *at tree level* (no loops)



@TBA

Vertexes:

3 – gluons :  $A \propto g$

4 – gluons :  $A \propto g^2$

Compare:

In QED, photon-photon scattering amplitude occurs at order  $\alpha^2$  through the 1-loop diagram

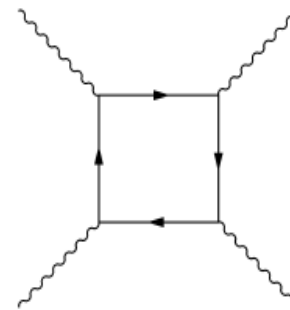

# Comparing QED and QCD - I

38

Compare the different situations:

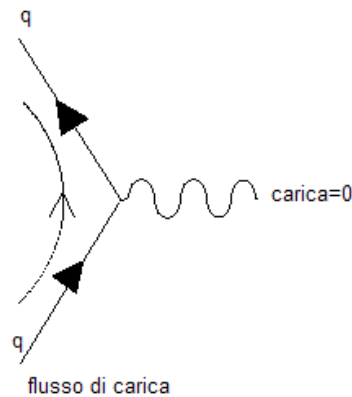

QED

Photon is *neutral*

Neither sourcing,  
nor sinking charge

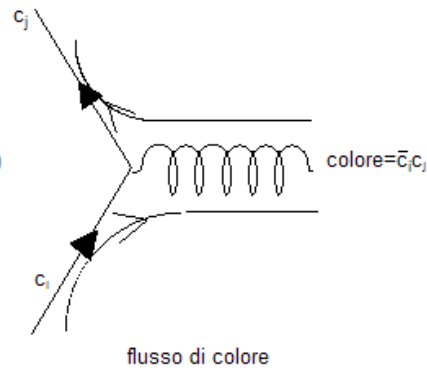

QCD

Gluon is *colored*

Sourcing color,  
sinking anti-color

# Comparing QED and QCD - II

39

Comparison of coupling constants:

$\alpha$  vs.  $\alpha_s$     Adimensional constants (*Interaction strength*)

Can define elementary charge in terms of  $\alpha$ ,  $\alpha_s$

Measure particle charge by its ratio to elementary charge:

*Number*

What are the allowed values for these numbers?

# Comparing QED and QCD - III

40

QED: Gauge group is *Abelian*

Electric charge can be *any* number:

No reason for charge quantization → So electric charge quantization is a bit of a mystery

[Tricky business: Sticking to perturbation theory, one must have the SM *anomaly-free* in order to be renormalizable → This in turn *requires* charge quantization.

But: Is the SM just perturbation theory?

At a fundamental level, Grand Unified Theories explain charge quantization based on larger symmetry groups like  $SU(5)$ .

But: They fail to explain proton stability]

Photon charge is strictly 0

QCD: Gauge group is *non Abelian*

“Color charge” value is *fixed* for every representation

Quarks:  $\mathbf{3}, \mathbf{3}^*$  →  $Q = 4/3$

Gluons:  $\mathbf{8}$  →  $Q = 3$

Similar to  $I(I+1)$  for any isospin ( $SU(2)$ ) multiplet

# Color Factors - I

41

Consider the static interaction between 2 charges:

*QED* For fixed  $|q|$ , the 'charge factor' can be defined as:

$$f_{12} = \frac{q_1 q_2}{|q|^2} = \begin{cases} +1 & q_1 q_2 > 0 \\ -1 & q_1 q_2 < 0 \end{cases}$$

Very simple for an Abelian interaction

*QCD* The 'color factor' depends on the irr.rep. of the color state

*Representation dependent*

*Identical for any transition in a given representation*

*→Color Conservation*

Less simple in this non-Abelian interaction

# Color Factors - II

42

$$q\bar{q} \rightarrow q\bar{q}$$

$$\mathbf{3} \otimes \mathbf{3}^* = \mathbf{1} \oplus \mathbf{8}$$

Total color conservation:  $\begin{cases} \mathbf{1} \rightarrow \mathbf{1} \\ \mathbf{8} \rightarrow \mathbf{8} \end{cases}$

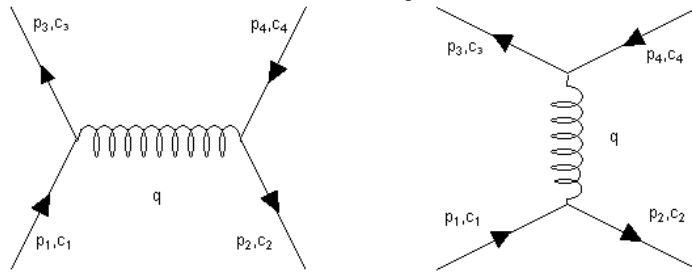

Observe:

Similar to conservation of total I-spin

$$T_{fi} = i \sum_{\alpha, \beta=1}^8 \underbrace{[\bar{u}(3)c_3^\dagger] \left[ -i \frac{g_s}{2} \lambda^\alpha \gamma^\mu \right] [u(1)c_1]}_{\text{color current}} \underbrace{\left[ -i \frac{g_{\mu\nu} \delta^{\alpha\beta}}{q^2} \right]}_{\text{propagator}} \underbrace{[\bar{v}(2)c_2^\dagger] \left[ -i \frac{g_s}{2} \lambda^\beta \gamma^\nu \right] [v(4)c_4]}_{\text{color current}}$$

Sum is over all 8 color matrices

$c_i$  are the color states of initial, final  $q\bar{q}$

$$T_{fi} = \frac{-g_s^2}{q^2} [\bar{u}(3) \gamma^\mu u(1)] [\bar{v}(2) \gamma_\mu v(4)] \underbrace{\frac{1}{4} \sum_{\alpha} [c_3^\dagger \lambda^\alpha c_1] [c_2^\dagger \lambda^\alpha c_4]}_{\text{color factor}}$$

# Color Factors - III

43

Octet

$\bar{r}\bar{b}$

Just as an example: Result is the same for all octet states

$$\left. \begin{array}{l} c_1 = c_3 = \begin{pmatrix} 1 \\ 0 \\ 0 \end{pmatrix} \\ c_2 = c_4 = \begin{pmatrix} 0 \\ 1 \\ 0 \end{pmatrix} \end{array} \right\} \rightarrow f = \frac{1}{4} \sum_{\alpha=1}^8 (1 \ 0 \ 0) \lambda^\alpha \begin{pmatrix} 1 \\ 0 \\ 0 \end{pmatrix} (0 \ 1 \ 0) \lambda^\alpha \begin{pmatrix} 0 \\ 1 \\ 0 \end{pmatrix}$$

$$\rightarrow f = \frac{1}{4} \sum_{\alpha=1}^8 \lambda_{11}^\alpha \lambda_{22}^\alpha = \frac{1}{4} (\lambda_{11}^3 \lambda_{22}^3 + \lambda_{11}^8 \lambda_{22}^8) = -\frac{1}{6}$$

# Color Factors - IV

44

## Singlet

$$\frac{1}{\sqrt{3}}(r\bar{r} + b\bar{b} + g\bar{g}) \quad \text{Only this state in the singlet}$$

But: Any component can go into *any other*..

$$f_i = \frac{1}{4} \frac{1}{\sqrt{3}} \frac{1}{\sqrt{3}} \sum_{j=1}^3 \sum_{\alpha=1}^8 [c_i^\dagger \lambda^\alpha c_j] [c_j^\dagger \lambda^\alpha c_i], \quad i=1,2,3$$

$$f = \sum_{i=1}^3 f_i = \frac{1}{4} \frac{1}{\sqrt{3}} \frac{1}{\sqrt{3}} \sum_{\alpha=1}^8 \sum_{i,j=1}^3 \lambda_{ij}^\alpha \lambda_{ji}^\alpha = \frac{1}{12} \sum_{\alpha=1}^8 \text{Tr}(\lambda^\alpha \lambda^\alpha)$$

$$\text{Tr}(\lambda^\alpha \lambda^\beta) = 2\delta^{\alpha\beta} \rightarrow \sum_{\alpha=1}^8 \text{Tr}(\lambda^\alpha \lambda^\alpha) = 16$$

$$\rightarrow f = \frac{4}{3}$$



# Color Factors - V

45

$qq \rightarrow qq$

$$\mathbf{3} \otimes \mathbf{3} = \mathbf{3}^* \oplus \mathbf{6}$$

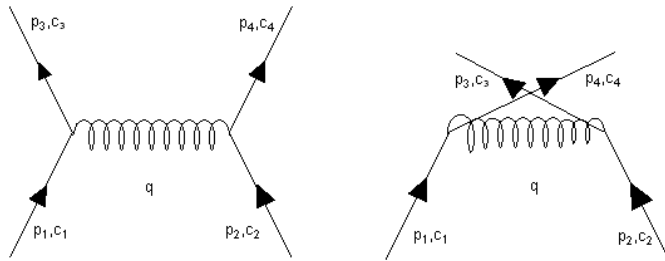

$$T_{fi} = \frac{-g_s^2}{q^2} [\bar{u}(3) \gamma^\mu u(1)] [\bar{u}(4) \gamma_\mu u(2)] \underbrace{\frac{1}{4} \sum_{\alpha=1}^8 [c_3^\dagger \lambda^\alpha c_1] [c_4^\dagger \lambda^\alpha c_2]}_{\text{color factor}}$$

$$f_{qq} = \frac{1}{4} \sum_{\alpha=1}^8 (c_3^\dagger \lambda^\alpha c_1) (c_4^\dagger \lambda^\alpha c_2)$$

# Color Factors - VI

46

Color states: Triplet and sextet:

$$\mathbf{3}^*: \quad \frac{1}{\sqrt{2}}(rb - br), \frac{1}{\sqrt{2}}(bg - gb), \frac{1}{\sqrt{2}}(gr - rg)$$

Antisymmetric

$$\mathbf{6}: \quad rr, bb, gg, \frac{1}{\sqrt{2}}(rb + br), \frac{1}{\sqrt{2}}(bg + gb), \frac{1}{\sqrt{2}}(gr + rg)$$

Symmetric

# Color Factors - VII

47

## Sextet

*rr*

Just as an example: Result is the same for all sextet states

$$c_1 = c_2 = c_3 = c_4 = \begin{pmatrix} 1 \\ 0 \\ 0 \end{pmatrix}$$

$$f = \frac{1}{4} \sum_{\alpha=1}^8 \left[ (1 \ 0 \ 0) \lambda^\alpha \begin{pmatrix} 1 \\ 0 \\ 0 \end{pmatrix} \right] \left[ (1 \ 0 \ 0) \lambda^\alpha \begin{pmatrix} 1 \\ 0 \\ 0 \end{pmatrix} \right] = \frac{1}{4} \sum_{\alpha=1}^8 (\lambda_{11}^\alpha \lambda_{11}^\alpha)$$
$$= \frac{1}{4} (\lambda_{11}^3 \lambda_{11}^3 + \lambda_{11}^8 \lambda_{11}^8) = \frac{1}{3}$$

# Color Factors - VIII

48

## Triplet

$$\frac{1}{\sqrt{2}}(rb - br) \quad \text{Just as an example as before}$$

$$f = \frac{1}{4} \frac{1}{\sqrt{2}} \frac{1}{\sqrt{2}} \sum_{\alpha=1}^8$$

$$\left\{ \left[ \begin{array}{ccc} (1 & 0 & 0) \lambda^\alpha \\ & \begin{pmatrix} 1 \\ 0 \\ 0 \end{pmatrix} \end{array} \right] \left[ \begin{array}{ccc} (0 & 1 & 0) \lambda^\alpha \\ & \begin{pmatrix} 0 \\ 1 \\ 0 \end{pmatrix} \end{array} \right] - \left[ \begin{array}{ccc} (0 & 1 & 0) \lambda^\alpha \\ & \begin{pmatrix} 1 \\ 0 \\ 0 \end{pmatrix} \end{array} \right] \left[ \begin{array}{ccc} (1 & 0 & 0) \lambda^\alpha \\ & \begin{pmatrix} 0 \\ 1 \\ 0 \end{pmatrix} \end{array} \right] \right.$$

$$\left. - \left[ \begin{array}{ccc} (1 & 0 & 0) \lambda^\alpha \\ & \begin{pmatrix} 0 \\ 1 \\ 0 \end{pmatrix} \end{array} \right] \left[ \begin{array}{ccc} (0 & 1 & 0) \lambda^\alpha \\ & \begin{pmatrix} 1 \\ 0 \\ 0 \end{pmatrix} \end{array} \right] - \left[ \begin{array}{ccc} (0 & 1 & 0) \lambda^\alpha \\ & \begin{pmatrix} 0 \\ 1 \\ 0 \end{pmatrix} \end{array} \right] \left[ \begin{array}{ccc} (1 & 0 & 0) \lambda^\alpha \\ & \begin{pmatrix} 1 \\ 0 \\ 0 \end{pmatrix} \end{array} \right] \right\}$$

$$f = \frac{1}{8} \sum_{\alpha=1}^8 \{ \lambda_{11}^\alpha \lambda_{22}^\alpha - \lambda_{21}^\alpha \lambda_{12}^\alpha - \lambda_{12}^\alpha \lambda_{21}^\alpha + \lambda_{22}^\alpha \lambda_{11}^\alpha \}$$

$$\rightarrow f = \frac{1}{4} \sum_{\alpha=1}^8 \{ \lambda_{11}^\alpha \lambda_{22}^\alpha - \lambda_{12}^\alpha \lambda_{21}^\alpha \} = \frac{1}{4} \{ \lambda_{11}^3 \lambda_{22}^3 + \lambda_{11}^8 \lambda_{22}^8 - \lambda_{12}^1 \lambda_{21}^1 - \lambda_{12}^2 \lambda_{21}^2 \} = -\frac{2}{3}$$

# Color Factors - IX

49

Matrix elements just calculated:

Very similar to the corresponding tree-level amplitudes in QED

→ Expect similar, Coulomb-like, effective potential in the static limit

Constant depends on the color representation for the quark pair:

$$V_{q\bar{q}} = \begin{cases} -\frac{4}{3} \frac{\alpha_s}{r} & \text{singlet} \\ \frac{1}{6} \frac{\alpha_s}{r} & \text{octet} \end{cases} \quad \text{Attractive}$$
$$V_{qq} = \begin{cases} -\frac{2}{3} \frac{\alpha_s}{r} & \text{triplet} \\ \frac{1}{3} \frac{\alpha_s}{r} & \text{sextet} \end{cases} \quad \text{Attractive}$$

Expect maximal attraction in singlet

# Color Factors - X

50

Baryons could be in any one of the **1,8,10** representations:

Why only the singlet is observed?

A hint of an explanation:

$$\mathbf{3} \otimes \mathbf{3} \otimes \mathbf{3} = (\mathbf{3} \otimes \mathbf{3}) \otimes \mathbf{3}$$

$$\mathbf{3} \otimes \mathbf{3} = \mathbf{6} \oplus \mathbf{3}^* \rightarrow (\mathbf{3} \otimes \mathbf{3}) \otimes \mathbf{3} = (\mathbf{6} \oplus \mathbf{3}^*) \otimes \mathbf{3}$$

$$\mathbf{6} \otimes \mathbf{3} = \mathbf{10} \oplus \mathbf{8}$$

$$\mathbf{3}^* \otimes \mathbf{3} = \mathbf{1} \oplus \mathbf{8}$$

**1:** each *qq* pair is a triplet  $\rightarrow$  attractive

**8:** *qq* pair can be triplets, or sextet  $\rightarrow$  attractive + repulsive

**10:** each *qq* pair is a sextet  $\rightarrow$  repulsive

So singlet is the state maximally attractive for 3 quarks

Does this explain the singlet-only mystery of bound states?

# Running Coupling: QED - I

51

Consider the *one loop* modification to the photon propagator:

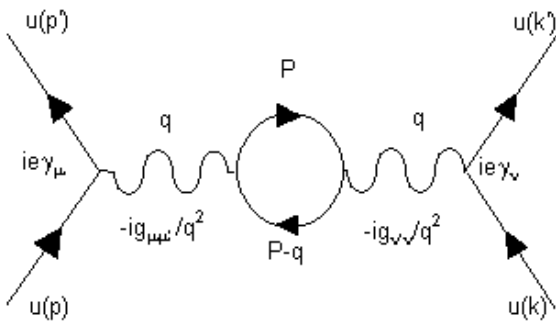

Includes a sum over  $P$ , the momentum circulating in the virtual loop. No obvious bounds on  $P$ .

$$M \propto [e\bar{u}(k')\gamma^\mu u(k)] \frac{g_{\mu\mu'}}{q^2} \frac{1}{(2\pi)^4} \int d^4P \frac{[e\bar{u}(P)\gamma^{\mu'} u(P-q)] [e\bar{u}(P-q)\gamma^{\nu'} u(P)]}{P^2 - m^2} \frac{g_{\nu\nu'}}{q^2} [e\bar{u}(p')\gamma^\nu u(p)]$$

Modified propagator:

$$\frac{g_{\mu\nu}}{q^2} \rightarrow \frac{g_{\mu\nu}}{q^2} (1 - I(q^2)), \quad I(q^2) = \frac{\alpha}{3\pi} \int_{m^2}^{\infty} \frac{dp^2}{p^2} - \frac{2\alpha}{\pi} \int_0^1 dx x(1-x) \ln \left[ 1 - \frac{q^2 x(1-x)}{m^2} \right]$$

# Running Coupling: QED - II

52

Take the high  $q^2$  approximation

$$-q^2 \gg m^2 \rightarrow \ln \left[ 1 - \frac{q^2 x(1-x)}{m^2} \right] \approx \ln \left[ -\frac{q^2}{m^2} \right]$$

Provisional upper bound (cutoff) to make integral converging

$$I(q^2) \approx \frac{\alpha}{3\pi} \int_{m^2}^{M^2} \frac{dp^2}{p^2} - \frac{2\alpha}{\pi} \int_0^1 dx x(1-x) \ln \left[ \frac{-q^2}{m^2} \right]$$

$$I(q^2) \approx \frac{\alpha}{3\pi} \ln \left( \frac{M^2}{m^2} \right) - \frac{2\alpha}{\pi} \frac{1}{6} \ln \left[ \frac{-q^2}{m^2} \right] = \frac{\alpha}{3\pi} \left[ \ln \left( \frac{M^2}{m^2} \right) - \ln \left[ \frac{-q^2}{m^2} \right] \right] = \frac{\alpha}{3\pi} \ln \left( \frac{M^2}{-q^2} \right)$$

$$M \propto \alpha \left[ \bar{u}(k') \gamma^\mu u(k) \right] \frac{g_{\mu\nu}}{q^2} \left[ 1 - \frac{\alpha}{3\pi} \ln \left( \frac{M^2}{-q^2} \right) \right] \left[ \bar{u}(p') \gamma^\nu u(p) \right]$$

Cartoon translation:

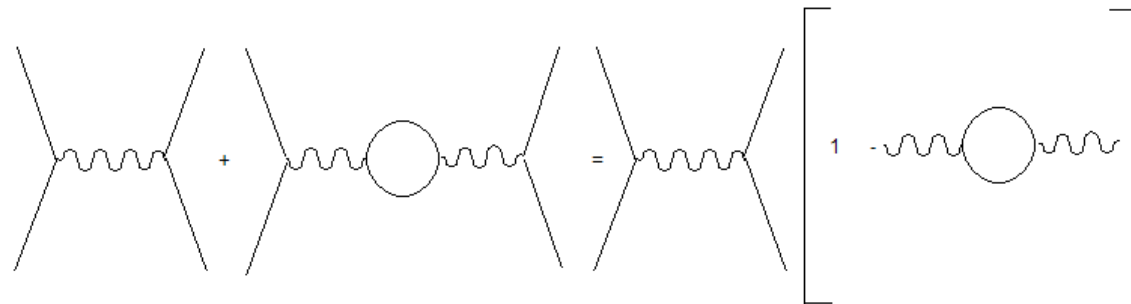



# Running Coupling: QED - III

53

Extend to diagrams with  $2, 3, \dots, n, \dots$  loops: Add up all contributes

Sum of a 'geometrical series': Converging ??

$$\begin{aligned}
 M &\propto \left[ \text{tree} + \alpha \left( \text{tree} \cdot \text{loop} + \text{tree} \cdot \text{loop}^2 + \dots \right) \right] \\
 &= \text{tree} \cdot \left[ \frac{1}{1 + \alpha \cdot \text{loop}} \right]
 \end{aligned}$$

Experts say this is the only contribution to running  $\alpha$  to the 'leading logs' approximation, which means neglecting the next levels of iteration

# Running Coupling: QED - IV

54

$$M \propto [\bar{u}(k') \gamma^\mu u(k)] \frac{g_{\mu\nu}}{q^2} \left[ \frac{\alpha}{1 + \alpha/3\pi \ln(M^2/-q^2)} \right] [\bar{u}(p') \gamma^\nu u(p)]$$

What is  $\alpha$ ?

Coupling 'constant' we would get should we turn off all loops

Call it  $\alpha_0$  = 'Bare' coupling constant, not physical:

Loops cannot be turned off

Then obtain an effective coupling, not constant but running:

$$\alpha(q^2) = \frac{\alpha_0}{1 + \alpha_0/3\pi \ln(M^2/-q^2)}$$

$\alpha$  is  $q^2$ , or distance, dependent!

# Running Coupling: QED - V

55

Running  $\alpha$  is still cutoff dependent, which of course is uncomfortable

But: Not a real problem.

Indeed:

$$Q^2 = -q^2 \rightarrow \alpha(Q^2) = \frac{\alpha_0}{1 + (\alpha_0/3\pi) \ln(M^2/Q^2)}$$

Take a particular energy scale:  $Q^2 = \mu^2$

$$\rightarrow \alpha(\mu^2) = \frac{\alpha_0}{1 + (\alpha_0/3\pi) \ln(M^2/\mu^2)}$$

Usually choose  $\mu^2=0$ , i.e. take  $\alpha$  at distance  $\rightarrow \infty$

Quite natural in QED (but not compulsory)

# Running Coupling: QED - VI

56

$$\ln\left(\frac{M^2}{Q^2}\right) = \ln\left(\frac{M^2}{Q^2} \frac{\mu^2}{\mu^2}\right) = \ln\left(\frac{M^2}{\mu^2}\right) + \ln\left(\frac{\mu^2}{Q^2}\right)$$

$$\rightarrow \alpha(Q^2) = \frac{\alpha_0}{1 + (\alpha_0/3\pi) \left[ \ln(M^2/\mu^2) + \ln(\mu^2/Q^2) \right]}$$

$$\rightarrow \frac{\alpha_0}{\alpha(\mu^2)} = 1 + (\alpha_0/3\pi) \ln(M^2/\mu^2)$$

$$\rightarrow \alpha(Q^2) = \frac{\alpha_0}{\alpha_0/\alpha(\mu^2) + (\alpha_0/3\pi) \ln(\mu^2/Q^2)} = \frac{\alpha(\mu^2)}{1 - [\alpha(\mu^2)/3\pi] \ln(Q^2/\mu^2)}$$

Very interesting result: Running  $\alpha$  depends on  $q^2$ , through its own *measured* value at any chosen energy scale  $\mu^2$ .

*Cutoff has disappeared.*

# Running Coupling: QED - VII

57

Deep physics involved:

A  $\infty$  number of diagrams can be formally replaced by a single, 1-photon diagram where the coupling 'constant' is running with  $q^2$

Result valid to the 'leading log' approximation

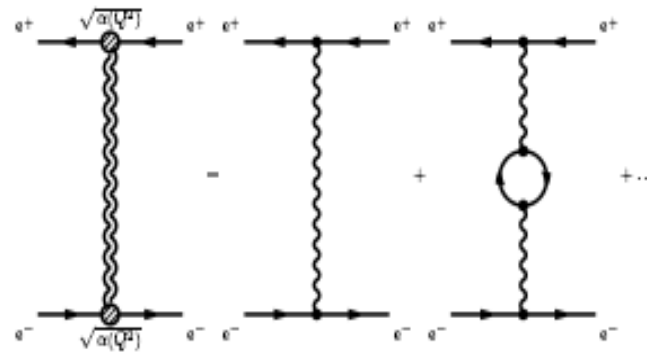

# Running Coupling: QED - VIII

58

Virtual (loops)  $e^+e^-$  pairs

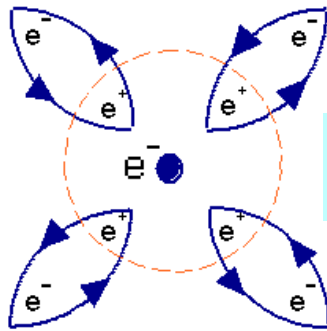

Effective shielding

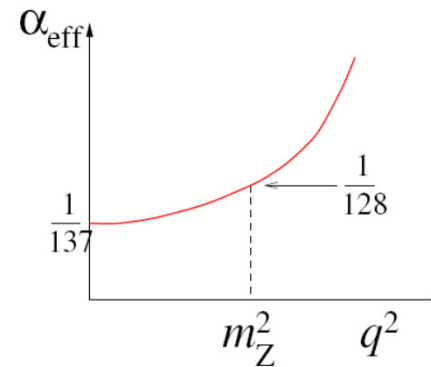
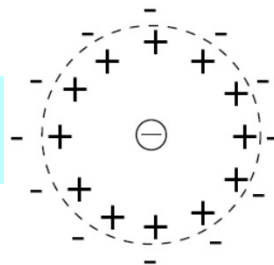

Picture the QED perturbative vacuum as a sort of (virtual) dielectric medium: Virtual photons and  $e^+e^-$  pairs continuously created/annihilated

Bare charge is shielded at large distance by the virtual pairs coming from loops.

The standard  $e$  charge is smaller than the bare charge

By probing the electron at smaller and smaller distance, observe an *increasing* effective charge

# Running $\alpha$ at LEP - I

59

Experimental method: Bhabha scattering

$\delta_\gamma, \delta_Z$   $s$ -channel contributions (small)

$\varepsilon$  radiative corrections (known)

Use accurate, differential cross-section measurement to unfold  $\alpha(t)$

[Total cross-section measurement would require a luminosity]

$$\frac{d\sigma}{dt} = \frac{d\sigma^0}{dt} \left( \frac{\alpha(t)}{\alpha_0} \right)^2 (1 + \varepsilon)(1 + \delta_\gamma) + \delta_Z,$$

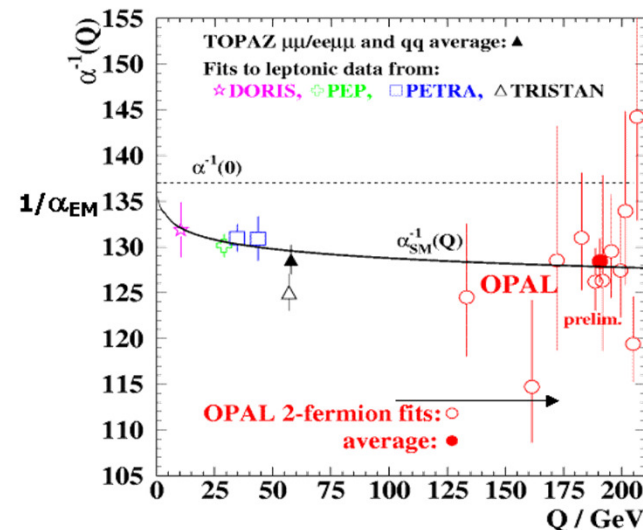
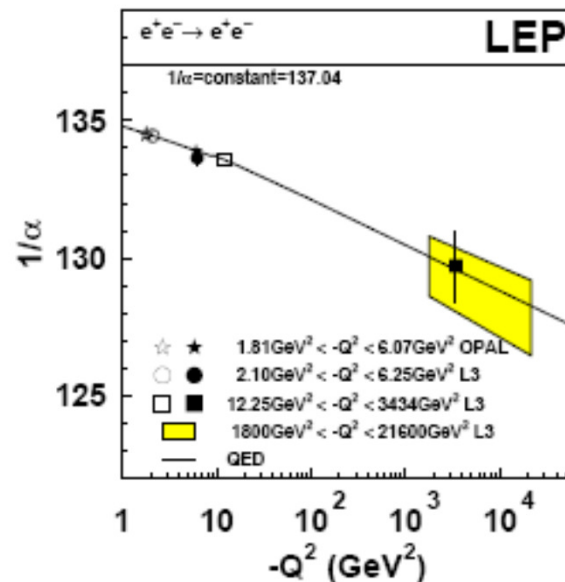

# Running $\alpha$ at LEP - II

60

Just as an example, take L3 at LEP:  
Relying on Bhabha scattering at small angle

$$\sigma = \frac{16\pi\alpha^2}{s} \left( \frac{1}{\theta_{min}^2} - \frac{1}{\theta_{max}^2} \right)$$

Calorimeter (Energy) + Silicon Tracker (Angle + Acceptance)

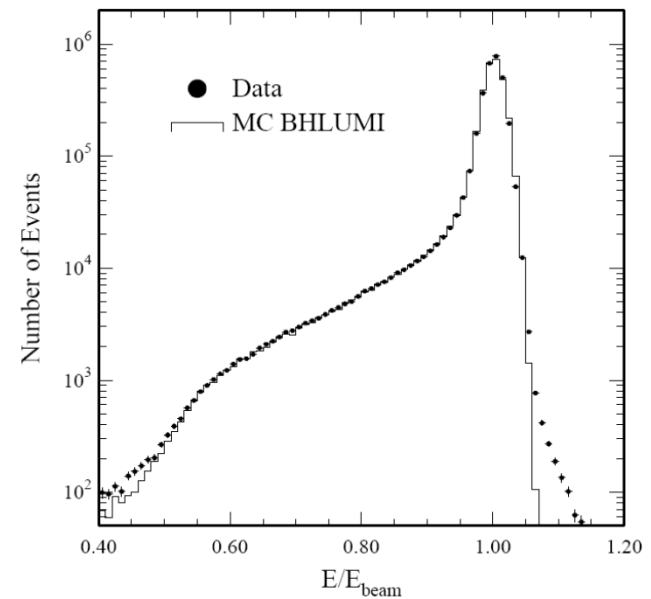
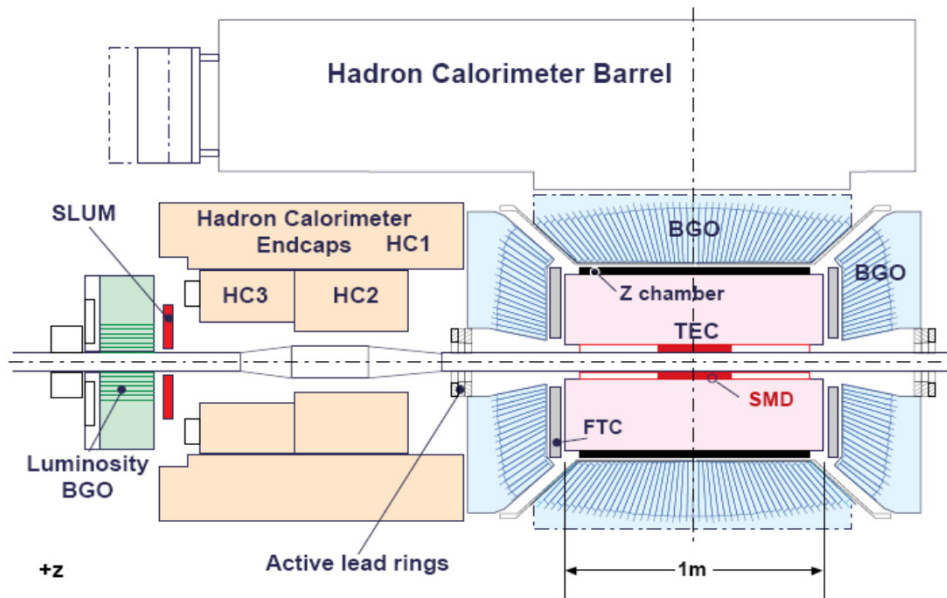



# Running Coupling: QCD - I

61

Repeat all the steps: Loops etc

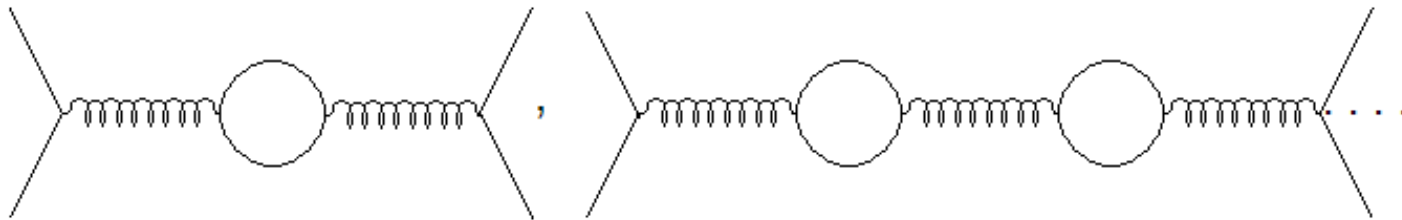

Except this time one has more loops: Gluons



# Running Coupling: QCD - II

62

Turns out gluon loops yield *anti*-shielding effect  
With 8 gluons and 6 quark flavors, gluons win

$$\alpha_s(|q^2|) = \frac{\alpha_s(\mu^2)}{1 + (\alpha_s(\mu^2)/12\pi)(33 - 2n_{\text{flavor}}) \ln(|q^2|/\mu^2)}$$

Running coupling *decreases* with increasing  $q^2$  (or at smaller distance)  
This is known as *asymptotic freedom*:

*Large  $q^2$  processes feature small coupling  $\rightarrow$  Perturbative!*

Most important consequence:

*The fundamental hypothesis behind the successful parton model is finally understood and justified*

# Running Coupling: QCD - III

63

Rather than making reference to a specific value of  $\alpha_s$

$$\alpha_s(|q^2|) = \frac{\alpha_s(\mu^2)}{1 + (\alpha_s(\mu^2)/12\pi)(33 - 2n_{flavor}) \ln(|q^2|/\mu^2)}$$

define a new constant

$$\ln \Lambda^2 = \ln \mu^2 - \frac{12\pi}{(33 - 2n_{flavor})\alpha_s(\mu^2)} \rightarrow \Lambda^2 = \mu^2 e^{-\frac{12\pi}{(33 - 2n_{flavor})\alpha_s(\mu^2)}}$$
$$\rightarrow \alpha_s(|q^2|) \simeq \frac{12\pi}{(33 - 2n_{flavor}) \ln(|q^2|/\Lambda^2)} = \frac{12\pi}{21 \ln(|q^2|/\Lambda^2)}, \quad |q^2| \gg \Lambda^2$$

$\Lambda$  = Renormalization scale  $\rightarrow$  Fixes  $\alpha_s$  at all  $q^2$

$\Lambda \approx 200 \text{ MeV}$  yields the correct  $\alpha_s$  at  $\mu^2 = M_{Z^0}^2$

Funny behavior, known as 'Dimensional Transmutation':

From an adimensional constant to a dimensional one  $\alpha_s \rightarrow \Lambda$

# Running Coupling: QCD - IV

64

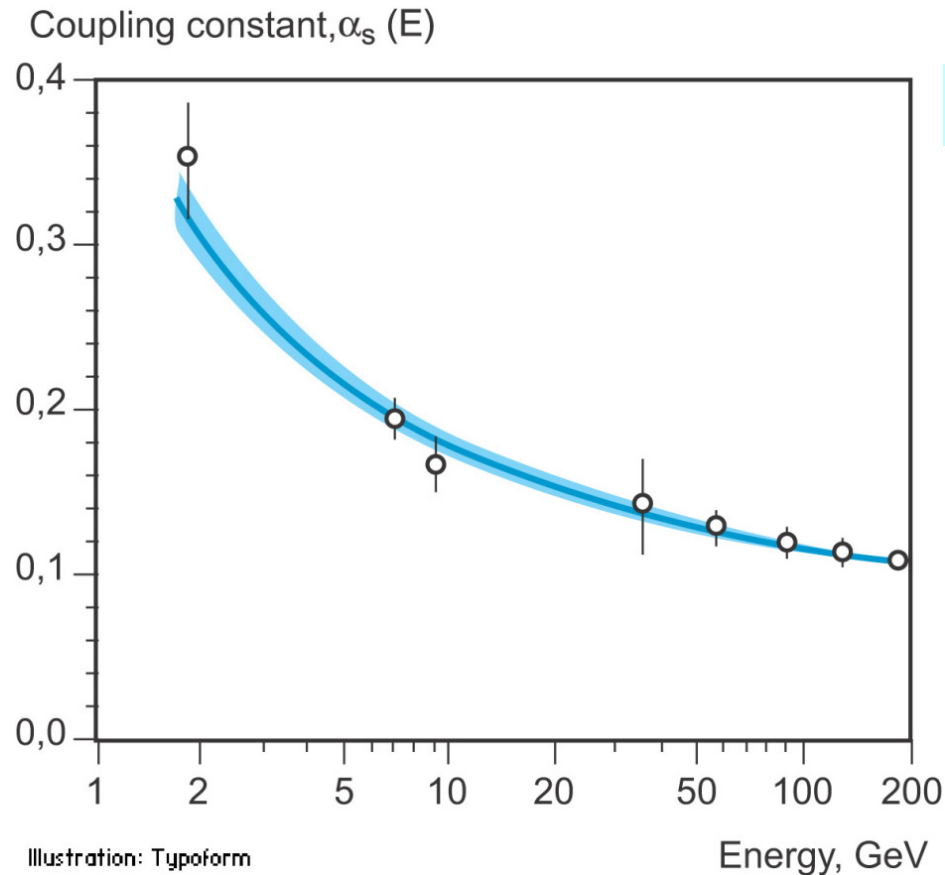

@TBA

Sources:

*Jets*

*DIS*

*Quarkonium*

Illustration: Typoform

# Annihilation: Muons vs Quarks

65

Electron-Positron annihilation:

Electroweak process

Low energy ( $E_{CM} \ll M_{Z^0}$ ): Mostly electromagnetic

High energy ( $E_{CM} \sim M_{Z^0}$ ): Mostly neutral current

Final state: *Fermion / Antifermion* pair

Muon vs quark pairs

Best observed at  $e^+e^-$  colliders

# Annihilation Cross-Section - I

66

Apply crossing symmetry to electron-muon scattering, take pure e.m. amplitude at tree level

$$e^- + \mu^- \rightarrow e^- + \mu^-$$

A: Scattering

$$e^- + \left[ e^- \right]_{\text{crossed}} \rightarrow \left[ \mu^- \right]_{\text{crossed}} + \mu^- \equiv e^- + e^+ \rightarrow \mu^+ + \mu^-$$

B: Annihilation

Amplitude for scattering:

$$T_{fi}(s, s', r, r') = (-e) \bar{u}_{(\mu)}(p_2', s') \gamma^\mu u_{(\mu)}(p_2, s) \frac{-ig_{\mu\nu}}{q^2} (-e) \bar{u}_{(e)}(p_1', r') \gamma^\nu u_{(e)}(p_1, r)$$

$$q = p_1 - p_1' \rightarrow q^2 = (p_1 - p_1')^2 = p_1^2 + p_1'^2 - 2p_1 \cdot p_1'$$

$$q^2 = 2m_e^2 - 2(E_1 E_1' - \mathbf{p}_1 \cdot \mathbf{p}_1') \underset{E \gg m}{\simeq} -2(E_1 E_1' - \mathbf{p}_1 \cdot \mathbf{p}_1') < 0$$

$q=4$ -momentum transfer

Amplitude for annihilation:

$$T_{fi}(s, s', r, r') = (-e) \bar{u}_{(\mu)}(p_2', s') \gamma^\mu v_{(\mu)}(p_1', r') \frac{-ig_{\mu\nu}}{q^2} (-e) \bar{v}_{(e)}(p_1, s) \gamma^\nu u_{(e)}(p_2, r)$$

$$q = p_1 + p_2 \rightarrow q^2 = (p_1 + p_2)^2 = p_1^2 + p_2^2 + 2p_1 \cdot p_2$$

$$q^2 = 2m_e^2 + 2(E_1 E_2 - \mathbf{p}_1 \cdot \mathbf{p}_2) \underset{E \gg m}{\simeq} 2(E_1 E_2 - \mathbf{p}_1 \cdot \mathbf{p}_2) > 0$$

$q$ =total 4-momentum

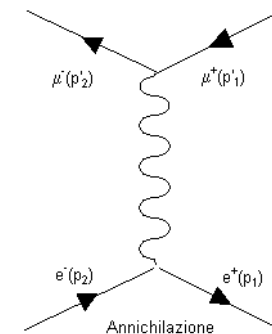
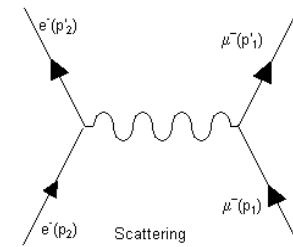

# Annihilation Cross-Section - II

67

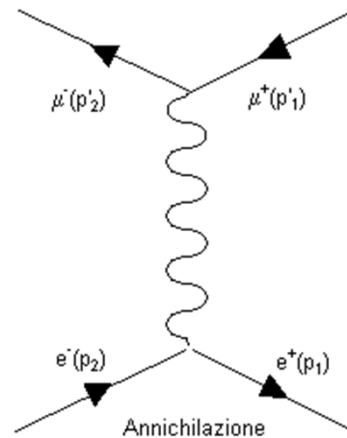

$$T_{fi} = \bar{v}(p_1, s') \gamma^\mu u(p_2, s) \frac{e^2}{q^2} \bar{u}(p_2', r) \gamma_\mu v(p_1', r')$$

$$|T_{fi}|^2 = \frac{e^4}{q^4} \left[ \bar{v}(p_1, s') \gamma^\mu u(p_2, s) \bar{u}(p_2', s) \gamma^\nu v(p_1', s') \right] \left[ \bar{v}(p_1, r) \gamma_\mu u(p_2, r') \bar{u}(p_2', r') \gamma_\nu v(p_1', r) \right]$$

# Annihilation Cross-Section - III

68

$$|T_{fi}|^2 = \frac{e^4}{q^4} \left[ \bar{v}(p_1, s') \gamma^\mu u(p_2, s) \bar{u}(p_2', s) \gamma^\nu v(p_1', s') \right] \left[ \bar{v}(p_1, r) \gamma_\mu u(p_2, r') \bar{u}(p_2', r') \gamma_\nu v(p_1', r) \right]$$

$$\langle |T_{fi}|^2 \rangle = \frac{1}{4} \sum_{s, s', r, r'} |T_{fi}|^2 = \frac{e^4}{4q^4} \text{Tr} \left[ (\not{p}_1 - m) \gamma^\mu (\not{p}_2 + m) \gamma^\nu \right] \text{Tr} \left[ (\not{p}_2' + M) \gamma_\mu (\not{p}_1' - M) \gamma_\nu \right]$$

$$\text{Tr} \left[ (\not{p}_1 - m) \gamma^\mu (\not{p}_2 + m) \gamma^\nu \right] = 4 \left[ p_1^\mu p_2^\nu + p_1^\nu p_2^\mu - g^{\mu\nu} (p_2 \cdot p_1 + m^2) \right]$$

$$\text{Tr} \left[ (\not{p}_2' + M) \gamma_\mu (\not{p}_1' - M) \gamma_\nu \right] = 4 \left[ p_1'^\mu p_2'^\nu + p_1'^\nu p_2'^\mu - g^{\mu\nu} (p_2' \cdot p_1' + M^2) \right]$$

$$\rightarrow \langle |T_{fi}|^2 \rangle = \frac{8e^4}{q^4} \left[ (p_1 \cdot p_1') (p_2 \cdot p_2') + (p_1 \cdot p_2') (p_2 \cdot p_1') + M^2 (p_1 \cdot p_2) \right] \quad m \approx 0$$

$$CM : \begin{cases} p_1 = (E \ 0 \ 0 \ E), p_2 = (E \ 0 \ 0 \ -E) \\ |\mathbf{p}'| = |\mathbf{p}_1'| = |\mathbf{p}_2'| = \sqrt{E^2 - M^2} \end{cases}$$

$$p_1' = (E \ |\mathbf{p}'| \sin \theta \ 0 \ |\mathbf{p}'| \cos \theta), p_2' = (E \ -|\mathbf{p}'| \sin \theta \ 0 \ -|\mathbf{p}'| \cos \theta)$$

$$\rightarrow \langle |T_{fi}|^2 \rangle = e^4 \left[ 1 + \frac{M^2}{E^2} + \left( 1 - \frac{M^2}{E^2} \right) \cos^2 \theta \right]$$



# Annihilation Cross-Section - IV

69

$$\left. \frac{d\sigma}{d\Omega} \right|_{CM} = \frac{\alpha^2}{4s} \sqrt{1 - \frac{M^2}{E^2}} \left[ 1 + \frac{M^2}{E^2} + \left( 1 - \frac{M^2}{E^2} \right) \cos^2 \theta \right]$$

$$\rightarrow \left. \frac{d\sigma}{d\Omega} \right|_{CM} \approx \frac{\alpha^2}{4s} (1 + \cos^2 \theta), \quad E \gg M$$

$$\sigma = \int_{\Omega} \frac{d\sigma}{d\Omega} d\Omega = \frac{4\pi\alpha^2}{3s} \sqrt{1 - \frac{M^2}{E^2}} \left( 1 + \frac{1}{2} \frac{M^2}{E^2} \right)$$

$$\gamma = \frac{E}{M} = \frac{1}{\sqrt{1 - \beta^2}}$$

$$\rightarrow \sigma = \frac{4\pi\alpha^2}{3s} \underbrace{\sqrt{\frac{\gamma^2 - 1}{\gamma^2}}}_{\beta} \left( \frac{1 + 2\gamma^2}{2\gamma^2} \right) = \frac{4\pi\alpha^2}{3s} \beta \left( \frac{1}{2\gamma^2} + 1 \right) = \frac{4\pi\alpha^2}{3s} \beta \left( \frac{3 - \beta^2}{2} \right)$$

$$\rightarrow \sigma \approx \frac{4\pi\alpha^2}{3s} = \frac{87}{s[\text{GeV}^2]} \text{nb}, \quad E \gg M$$

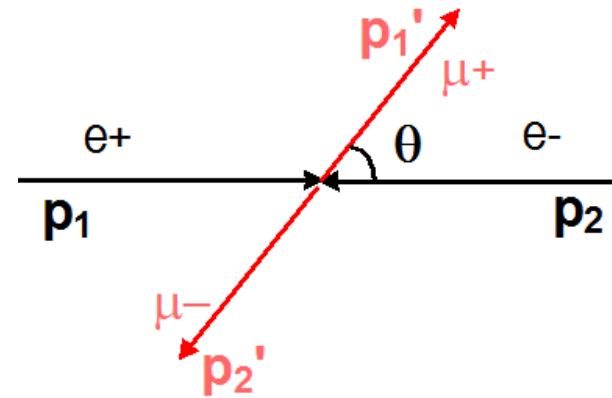

# Annihilation Cross-Section - V

70

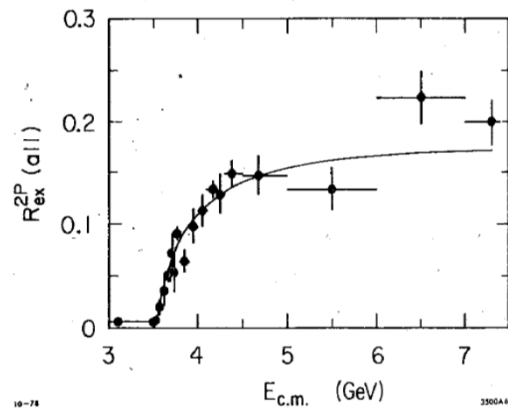
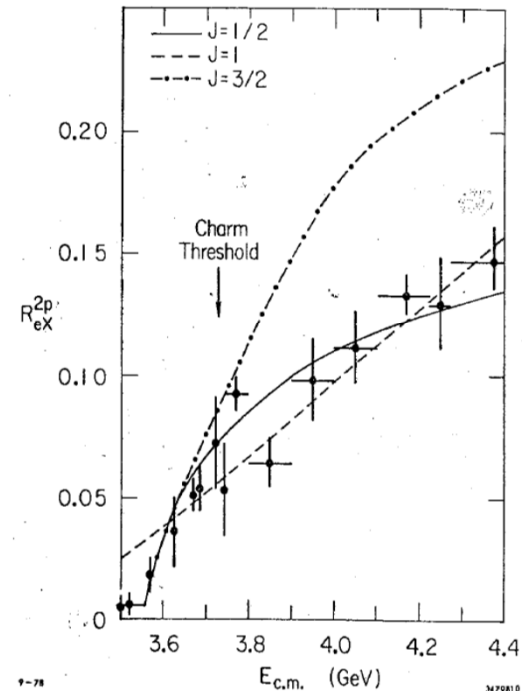

Figure 12b)



$\tau$  lepton discovery, mass & spin determination:

$$R_{eX}^{2p} \simeq \frac{\sigma(\tau^+\tau^-)}{\sigma(\mu^+\mu^-)} \simeq \sqrt{1 - \frac{M_\tau^2}{E^2}} \left( 1 + \frac{1}{2} \frac{M_\tau^2}{E^2} \right), M_\mu \approx 0$$

# Annihilation Cross-Section - VI

71

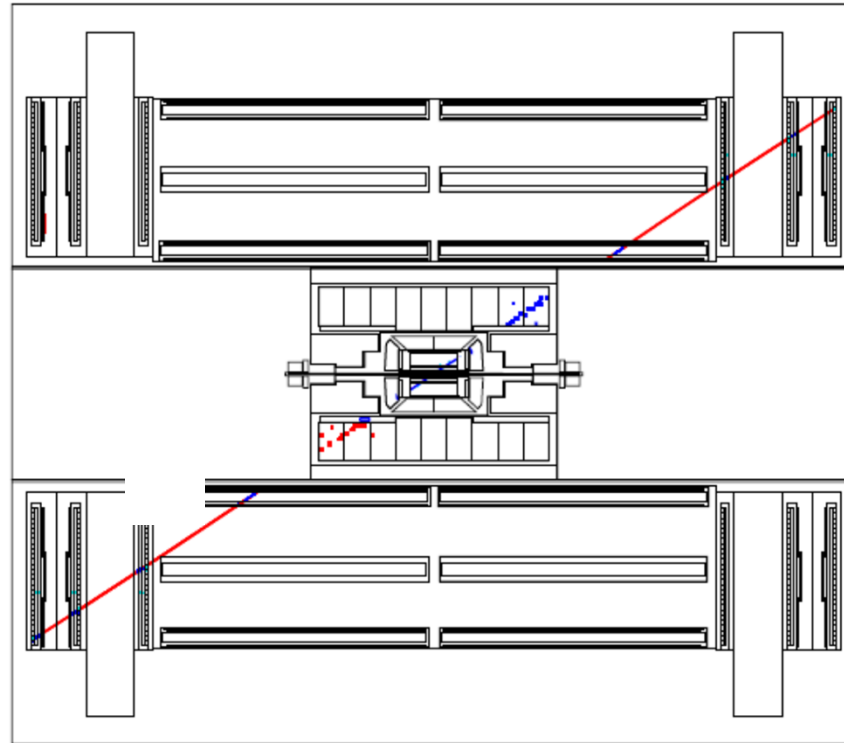

$\mu^+ \mu^-$  event: L3 detector at LEP

# Annihilation Cross-Section - VII

72

Total cross-section vs  $s$ :  
Low energy

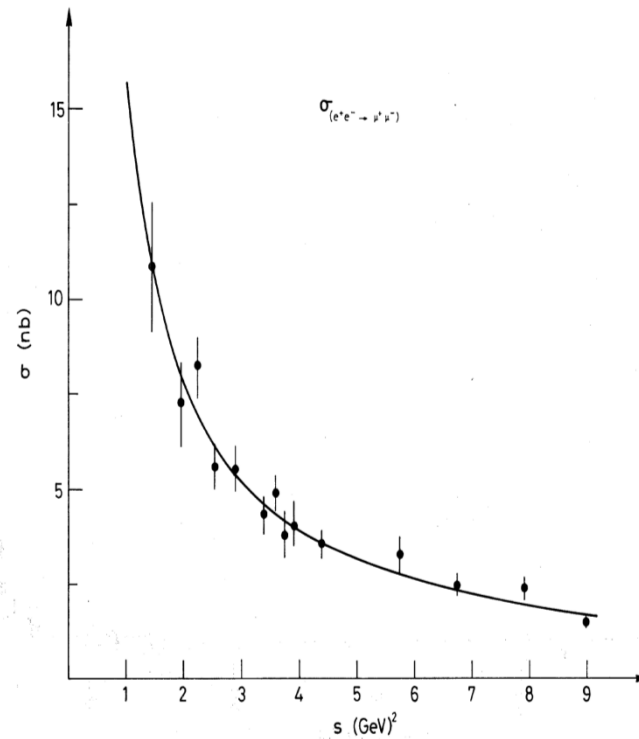

Fig. 3

ADONE ('70s)

# Annihilation Cross-Section - VIII

73

Total cross-section vs  $s$ :  
Higher energy

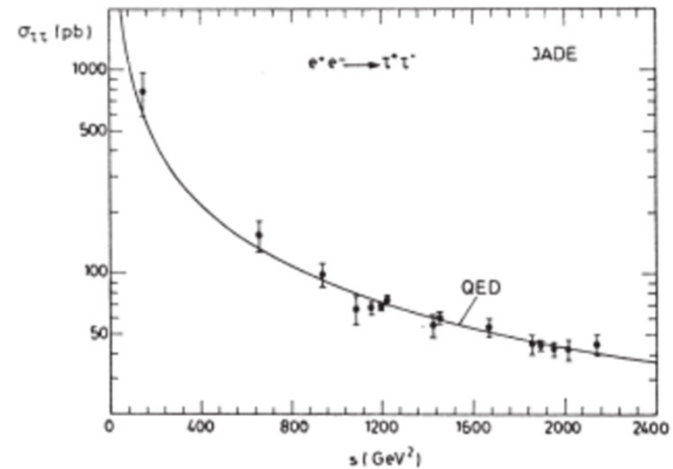
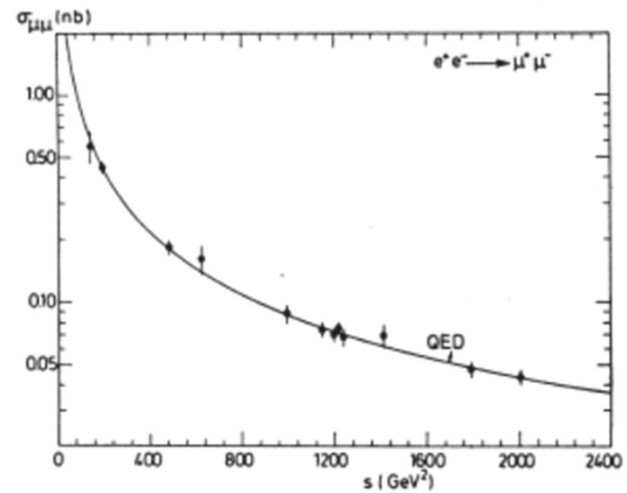

PETRA ('80s)

# Annihilation Cross-Section - IX

74

Angular distribution: Low energy  
1-photon, forward/backward symmetric

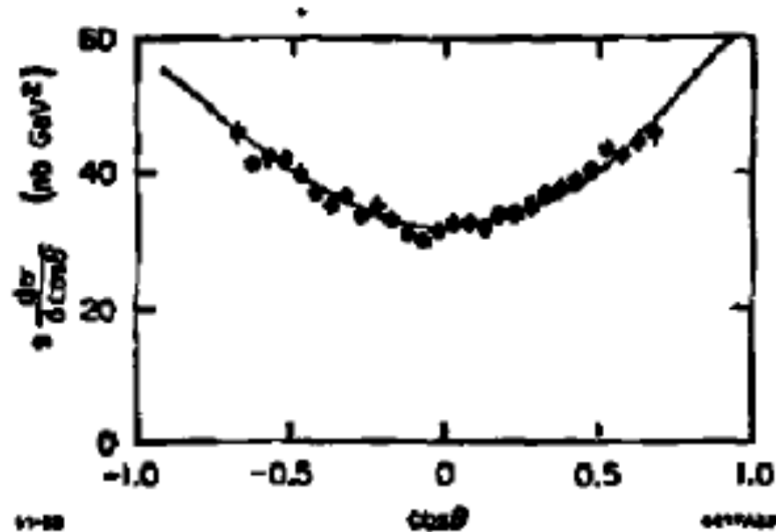

Fig. 15, MARK II  $e^+e^- \rightarrow u^+u^-$  at  
 $\langle E_{c.m.} \rangle^4 = 5.847$  compared to  $1 + \cos^2\theta$ .

SPEAR ('70s)

# Annihilation Cross-Section - X

75

Angular distribution: Higher energy:  
Some contribution from  $Z^0$ , forward/backward asymmetric

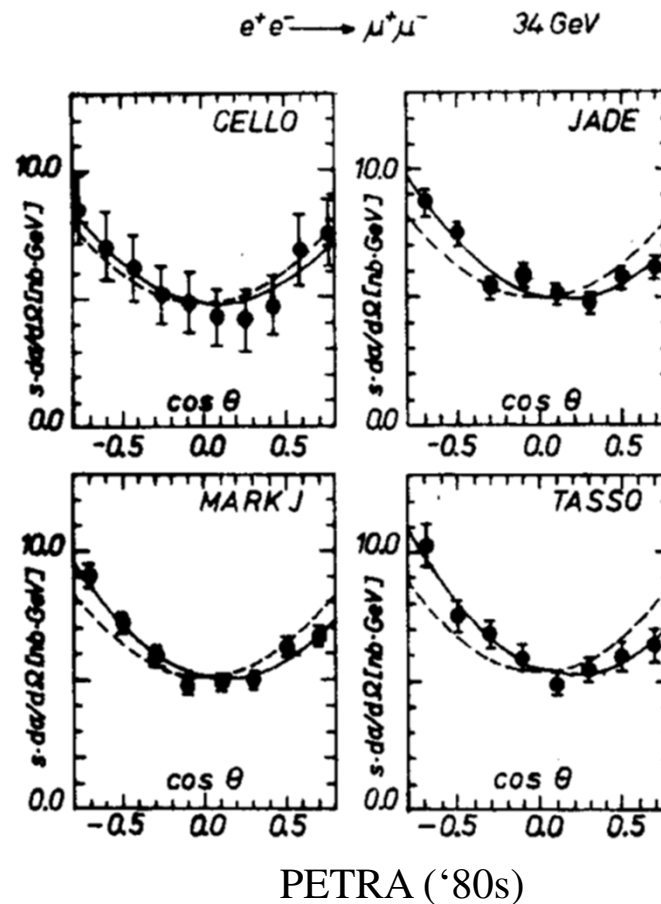

# Annihilation Cross-Section - XI

76

Forward/Backward asymmetry: Important subject

Effective tool for precision tests of SM

May probe physics BSM

Interesting point:

Some tiny asymmetry expected from pure QED

Coming from diagrams with  $>1$  photon (Radiative correctio

Dominated by interference terms

between amplitudes (a) and (b)-(g):

Opposite charge parity

Recent surge of interest from large asymmetry

found at Tevatron in  $t \bar{t}$  production by 1 and 2 gluons:

Similar physics, not fully understood

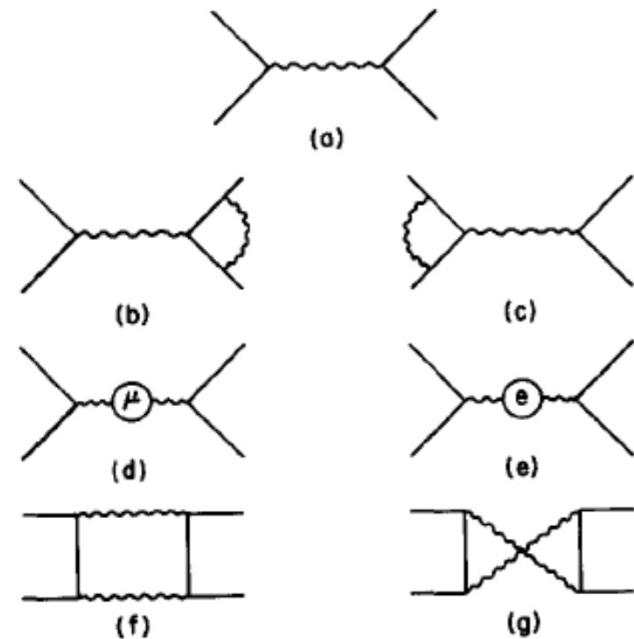



# PQCD: Jets in $e^+e^-$ Collisions - I

77

$e^+e^-$  annihilation into hadrons:

At the parton level = Crossed Deep Inelastic Scattering

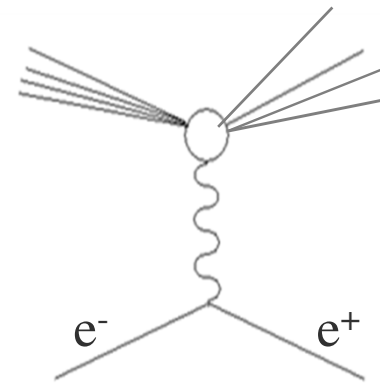
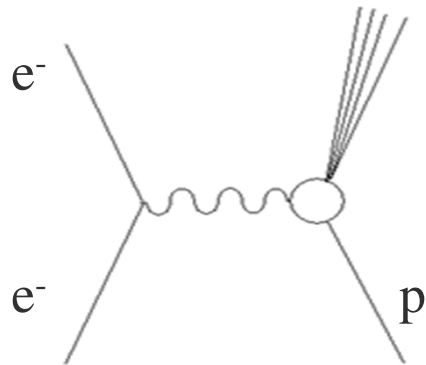

Understood as annihilation into a  $q\bar{q}$  pair,  
followed by quark fragmentation into hadrons

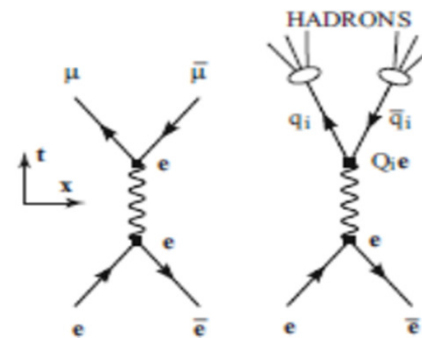

# PQCD: Jets in $e^+e^-$ Collisions - II

78

Picture of quark fragmentation

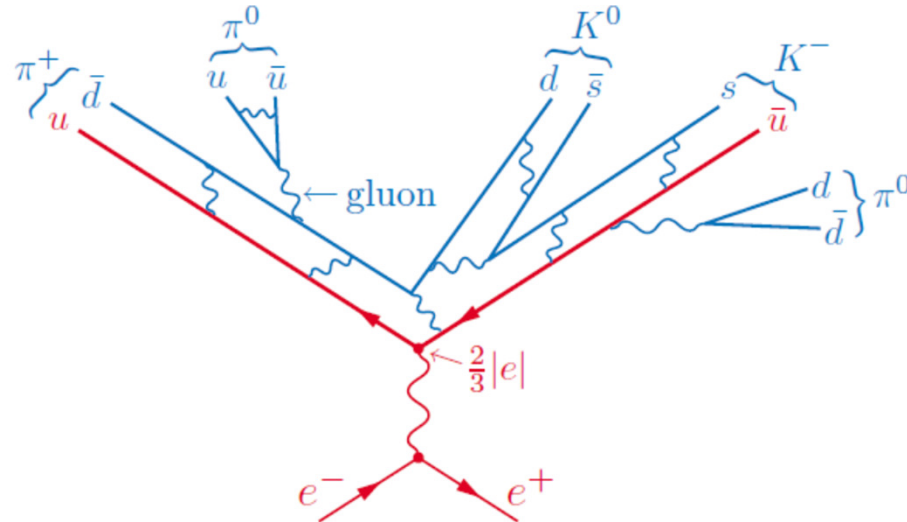

# PQCD: Jets in $e^+e^-$ Collisions - III

79

By ignoring *quark fragmentation* details

$$e^+ + e^- \rightarrow q + \bar{q} \rightarrow \text{hadrons}$$

$$\frac{d\sigma}{d\Omega} = \frac{3\alpha^2}{4s} (1 + \cos^2 \theta) \sum_{\text{flavor}} e_{\text{flavor}}^2$$

$$\rightarrow \sigma(s) = \frac{4\pi\alpha^2}{s} \sum_{\text{flavor}} e_{\text{flavor}}^2$$

Due to color confinement, quark/antiquark unobservable as free particles

Expect hadron debris from quark fragmentation

→ *Jets*

Hadrons: Trend towards grouping into narrow pencils of particles

Naive prediction: 2 jets

At high energy, expect hadronic annihilation events to be *non-spherical*

# PQCD: Jets in $e^+e^-$ Collisions - IV

80

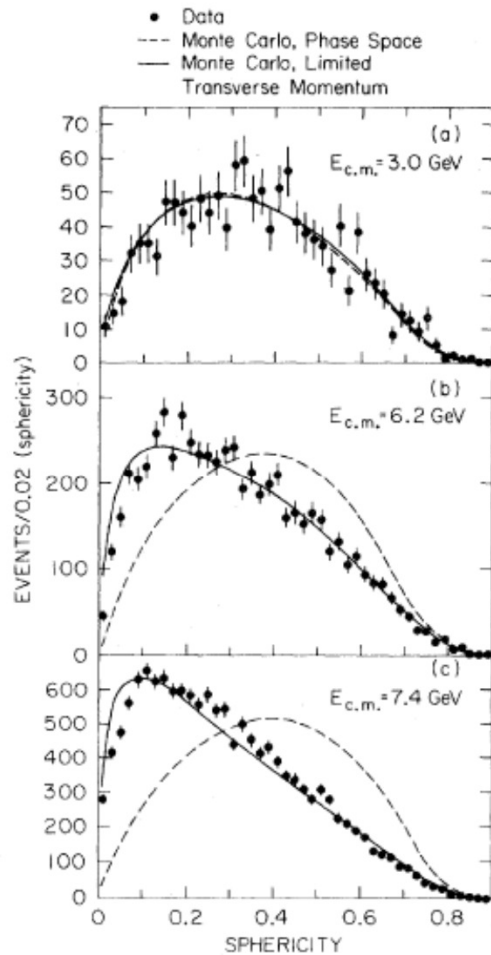

Define *sphericity* of events:

$$S = \min \frac{3 \sum_i p_{\perp i}^2}{2 \sum_i p_i^2} \rightarrow \begin{cases} 0 & \text{2-jets} \\ 1 & \text{spherical} \end{cases}$$

min : Choose axes which minimize  $S$  ( $\leftarrow$  *Iterative*)

# PQCD: Jets in $e^+e^-$ Collisions - V

81

Interesting observable: *Thrust*

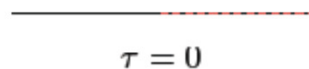

$$\tau = 0$$

$$T = \frac{1}{Q} \max_{\vec{n}} \sum_i |\vec{n} \cdot \vec{p}_i|$$

$$\tau = 1 - T'$$

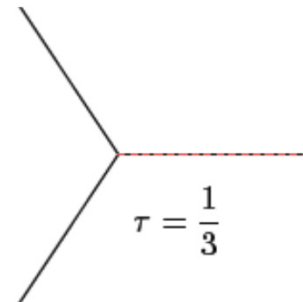

$$\tau = \frac{1}{3}$$

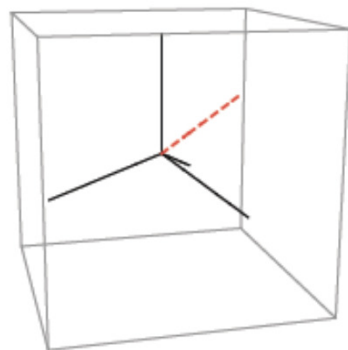

$$\tau = 1 - \frac{1}{\sqrt{3}} = 0.42$$

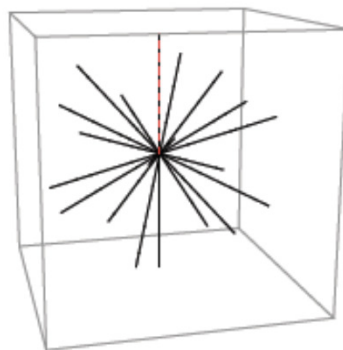

$$\tau = 0.48$$

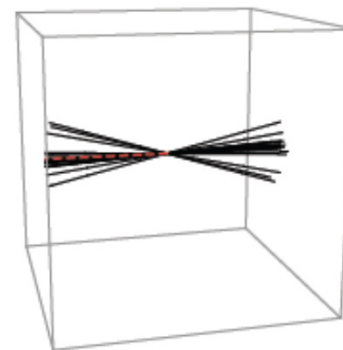

$$\tau = \frac{M_1^2 + M_2^2}{Q^2}$$

# PQCD: Jets in $e^+e^-$ Collisions - VI

82

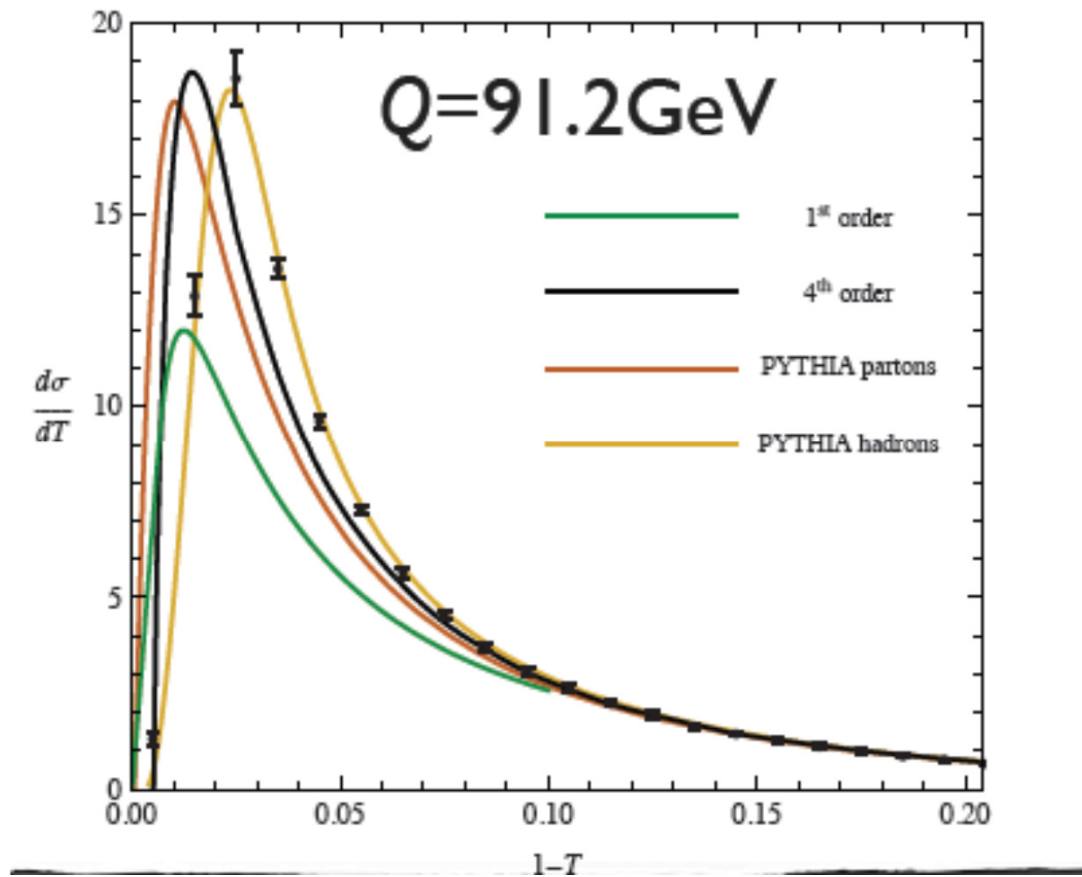

ALEPH

# PQCD: Jets in $e^+ e^-$ Collisions - VII

83

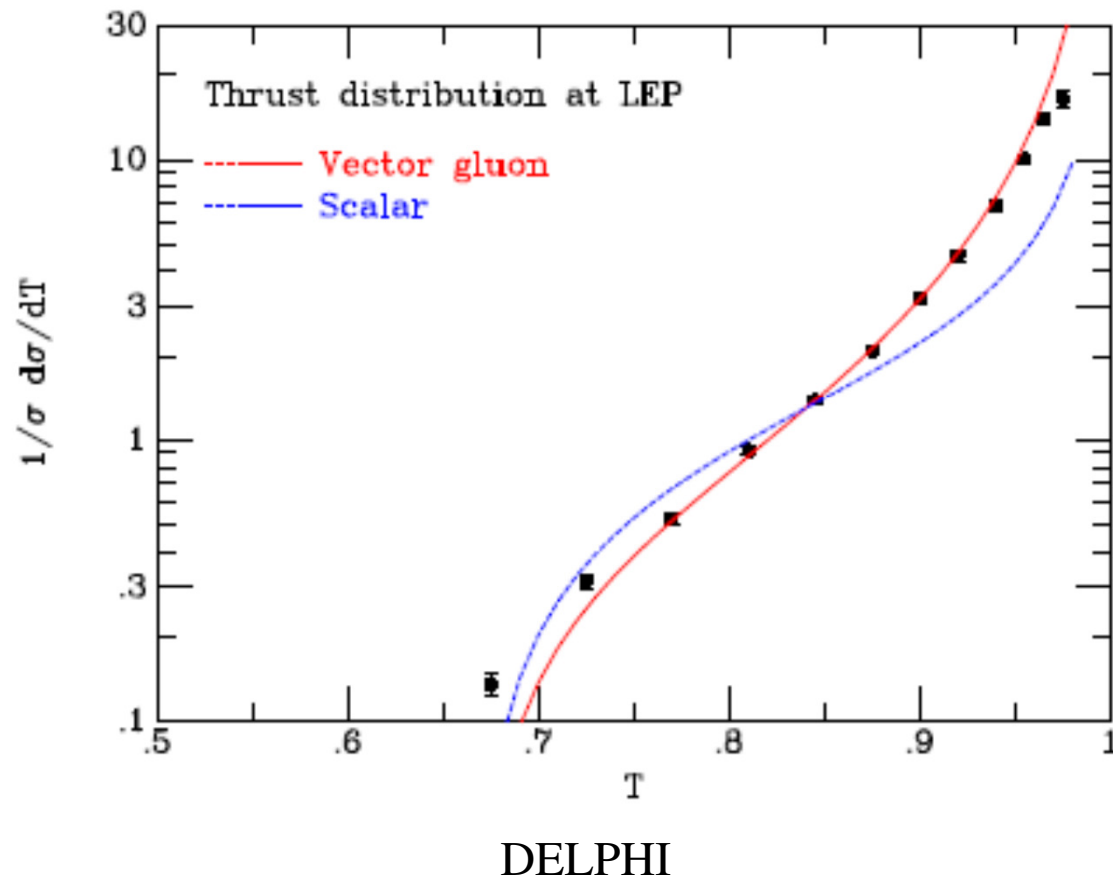

# PQCD: Jets in $e^+ e^-$ Collisions - VIII

84

For 2 jets events

$$\left. \begin{aligned} \frac{d\sigma}{d\Omega} &\propto 1 + \cos^2 \theta \quad \text{quark spin} = 1/2 \\ \frac{d\sigma}{d\Omega} &\propto 1 - \cos^2 \theta \quad \text{quark spin} = 0 \end{aligned} \right\} \equiv 1 + \alpha \cos^2 \theta$$

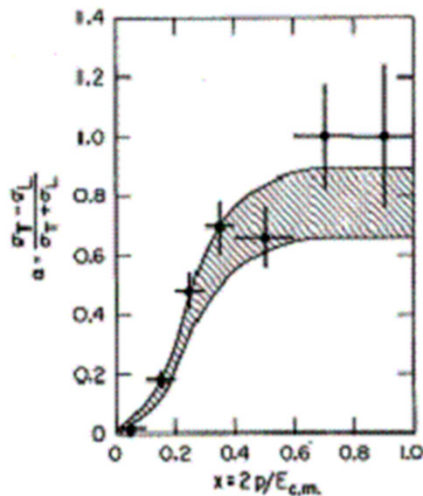

Mark I (SPEAR)  
 $E = \text{few GeV}$

@TBA

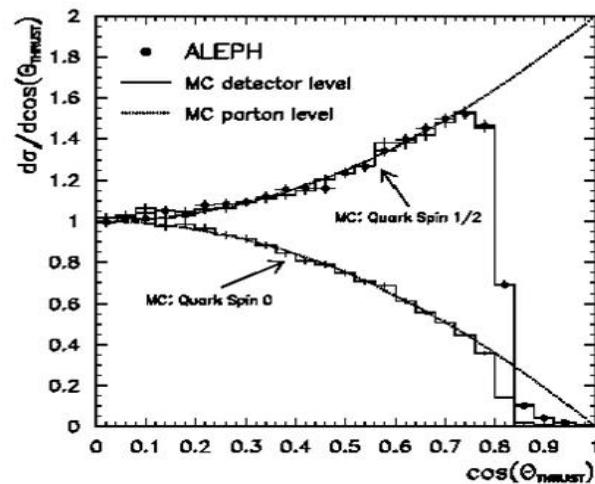

ALEPH (LEP)  
 $E = 90 \text{ GeV}$



# PQCD: Jets in $e^+e^-$ Collisions - IX

85

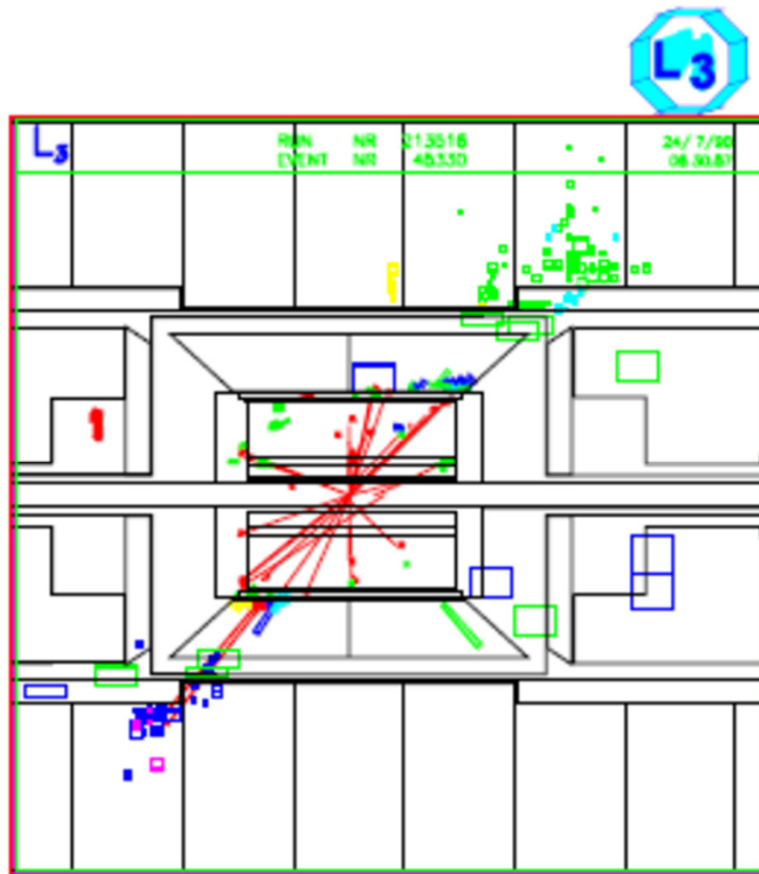

# PQCD: Jets in $e^+e^-$ Collisions - X

86

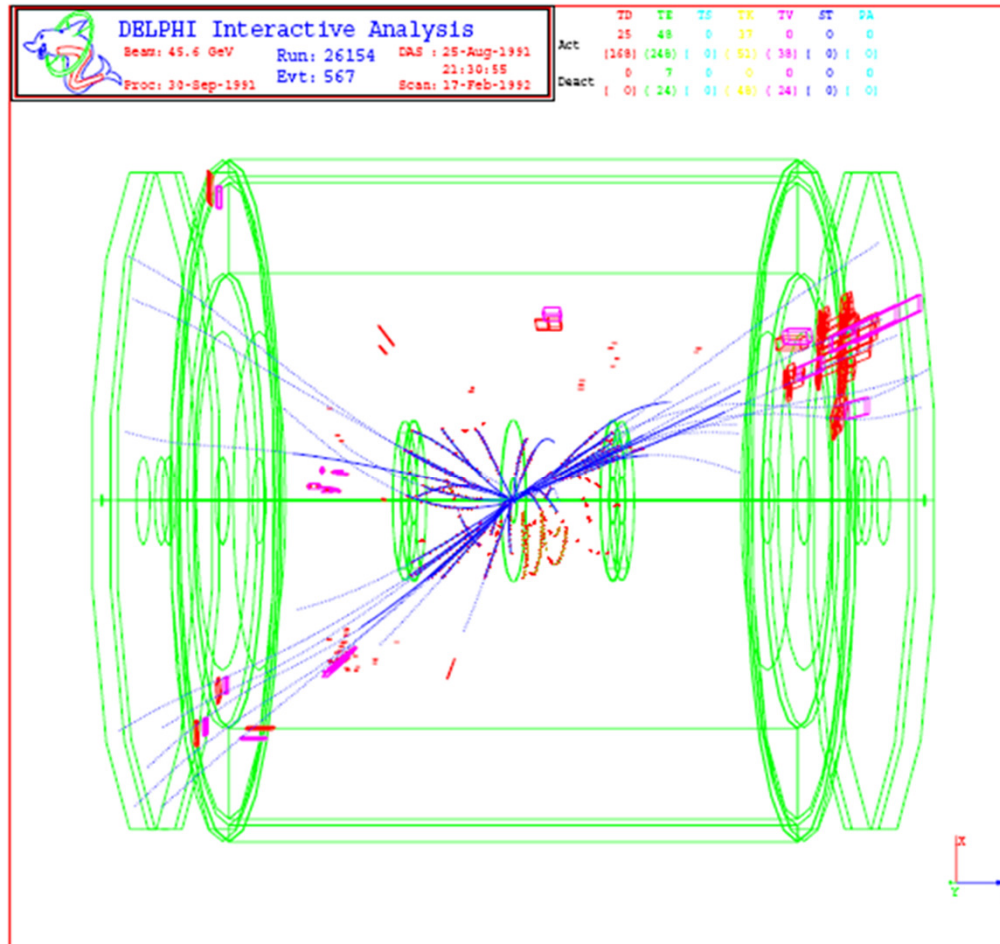

# PQCD: Jets in $e^+ e^-$ Collisions - XI

87

Total hadronic cross section  $\leftrightarrow R$  Ratio

Reminder:

Time scale of hard interaction

$$T \sim \frac{1}{Q} = \frac{1}{\sqrt{s}} \sim \frac{1}{\text{Many GeV}} \rightarrow \text{Very small}$$

Time scale of soft hadronization

$$\tau \sim \frac{1}{\Lambda} \sim \frac{1}{1 \text{ GeV}} \rightarrow \text{Large}$$

$\rightarrow$  Perturbative cross section OK

Expect at 30-40 GeV:

$$R = \frac{\sigma_{q\bar{q}}}{\sigma_{\mu\mu}} = 3 \sum_{i=u,d,s,c,b} Q_i^2 = \frac{11}{3} \approx 3.67 (+ 0.05 \text{ coming from } Z^0)$$

Measure :

$$R \approx 3.9$$

$\rightarrow QCD$  Correction required

# PQCD: Jets in $e^+ e^-$ Collisions - XII

88

QCD corrections Next to Leading Order (NLO):

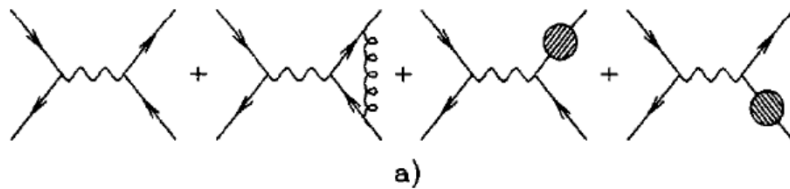

Virtual gluons

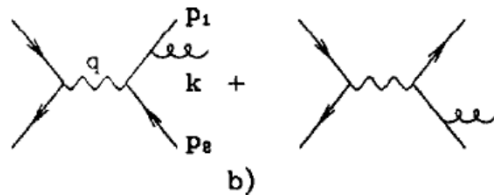

Real gluons

Real gluons: 3 particles in the final state

Some kinematics:

$$x_1 = \frac{2E_1}{\sqrt{s}}, x_2 = \frac{2E_2}{\sqrt{s}}$$

$$\rightarrow 0 \leq x_1, x_2 \leq 1, x_1 + x_2 \geq 1$$

$$x_3 = \frac{2E_g}{\sqrt{s}} = 2 - x_1 - x_2$$

# PQCD: Jets in $e^+ e^-$ Collisions - XIII

89

Observe:

Plane (2D) event

Within the event plane: 2 degrees of freedom

Differential cross section:

$$\frac{1}{\sigma} \frac{d^2\sigma}{dx_1 dx_2} = \frac{2\alpha_s}{3\pi} \frac{x_1^2 + x_2^2}{(1-x_1)(1-x_2)}$$

Basic remark:

$$x_1, x_2 \rightarrow 1 \quad \rightarrow \quad \sigma \rightarrow \infty$$

Also true to higher perturbative orders

$\rightarrow$  2 jets dominant over everything else

# PQCD: Jets in $e^+ e^-$ Collisions - XIV

90

Total hadronic cross section:

$$\sigma^{q\bar{q}s} = \sigma_0 3 \sum_q Q_q^2 \int \frac{d^2\sigma}{dx_1 dx_2} dx_1 dx_2 = \sigma_0 3 \sum_q Q_q^2 \int \frac{2\alpha_s}{3\pi} \frac{x_1^2 + x_2^2}{(1-x_1)(1-x_2)} dx_1 dx_2$$

In order to regularize diverging integrals: Funny and smart idea  
Shift to  $4-2\epsilon$  space-time dimensions, make them nicely converging..

Diagrams with real gluons:

$$\sigma^{q\bar{q}s} = \sigma_0 3 \sum_q Q_q^2 \frac{2\alpha_s}{3\pi} H(\epsilon) \left[ \frac{2}{\epsilon^2} - \frac{3}{\epsilon} + \frac{19}{2} + O(\epsilon) \right]$$

Diagrams with virtual gluons:

$$\sigma^{q\bar{q}s} = \sigma_0 3 \sum_q Q_q^2 \frac{2\alpha_s}{3\pi} H(\epsilon) \left[ -\frac{2}{\epsilon^2} + \frac{3}{\epsilon} - 8 + O(\epsilon) \right]$$

Adding everything up, and reverting to 4D:

$$R \xrightarrow{\epsilon \rightarrow 0} 3 \sum_q Q_q^2 \left\{ 1 + \frac{\alpha_s}{\pi} + O(\alpha_s^2) \right\} \simeq 3 \cdot \frac{11}{9} \left( 1 + \frac{0.14}{3.14} \right) = 3.83$$

$$R + R_{z^0} \simeq 3.83 + 0.05 = 3.88 \quad !!!$$

# PQCD: Jets in $e^+ e^-$ Collisions - XV

91

Absolute number of jets ill defined, both in theory and experiment

Can define number of jets as a function of some *resolution parameter*, according to a *clustering algorithm*

Example: *Durham algorithm*

Take  $q\bar{q}g$  final state

By fixing a  $y$  parameter as

$$m_{thresh}^2 = ys$$

compare the (invariant mass)<sup>2</sup> of each parton pair to  $m_{thresh}^2$

$$(p_i + p_j)^2 > ys \quad i, j = q, \bar{q}, g \quad 3 \text{ comb/event}$$

Then:

$$N_{hit} = N_{jet}$$

Of course,

$$R_{2jet} = R_{2jet}(y)$$
$$R_{3jet} = R_{3jet}(y)$$

Extend to  $n$  partons  $\rightarrow$  QCD predicts  $R_{k-jet}(y)$ !

# PQCD: Jets in $e^+ e^-$ Collisions - XVI

92

Jet algorithm for data: (modified) *Durham*

Define  $y_{cut}$

Loop over all particle pairs

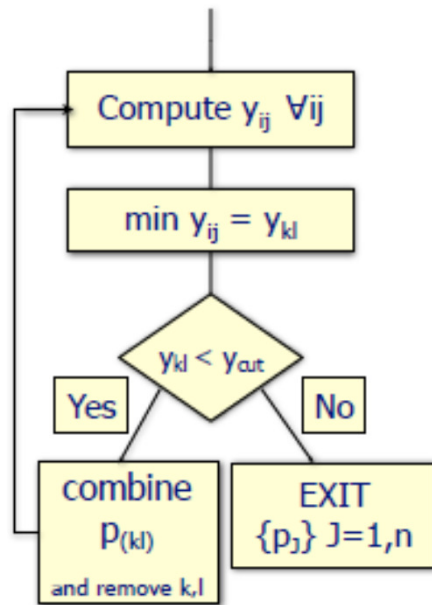

$$y_{ij} = \frac{2E_i E_j (1 - \cos \theta_{ij})}{s} \simeq \frac{m_{ij}^2}{s}$$

$$p_i = (E_i, \vec{p}_i)$$

$$p_j = (E_j, \vec{p}_j)$$

Exit with 4-momenta of  $n$  jets



# PQCD: Jets in $e^+ e^-$ Collisions - XVII

93

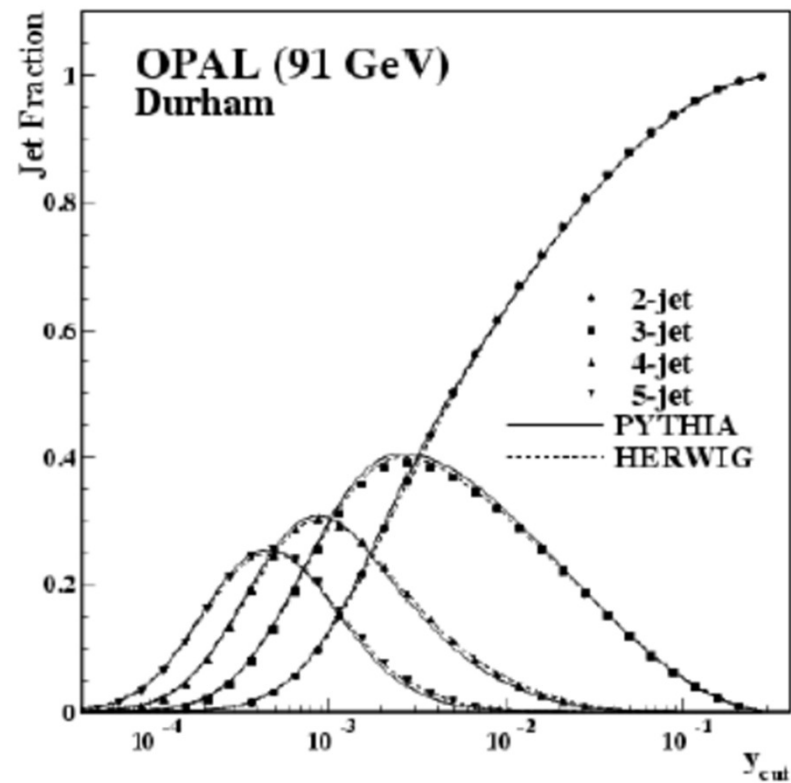

# PQCD: Jets in $e^+ e^-$ Collisions - XVIII

94

Exceptional 3-jet event from OPAL

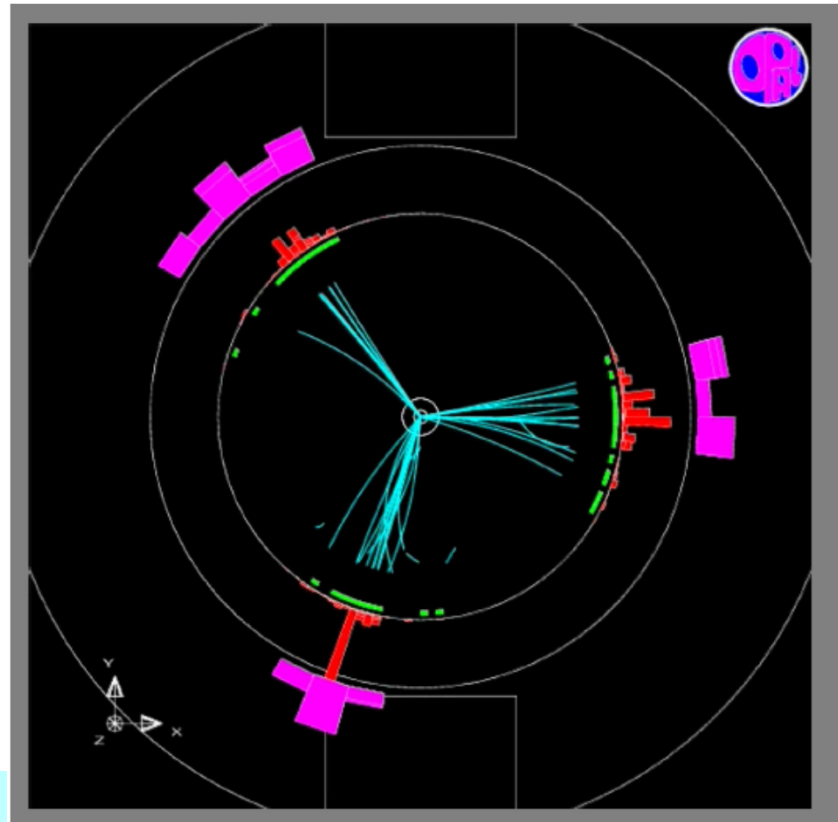
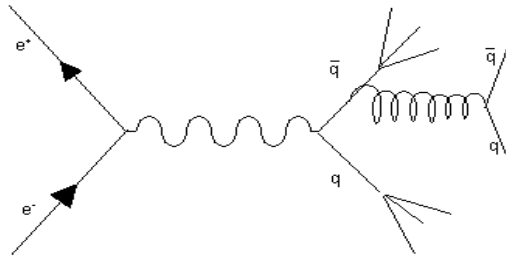

@TBA

# PQCD: Jets in $e^+e^-$ Collisions - XIX

95

Get a measurement of  $\alpha_s$  :

$$\alpha_s(35\text{GeV}) = 0.146 \pm 0.03$$

$$\alpha_s(M_{Z^0}) = 0.124 \pm 0.0043$$

$$R_3 \equiv \frac{\sigma_{3\text{-jet}}}{\sigma_{\text{tot}}} \propto \alpha_s(E_{\text{cm}}) \propto \frac{1}{\ln E_{\text{cm}}}$$

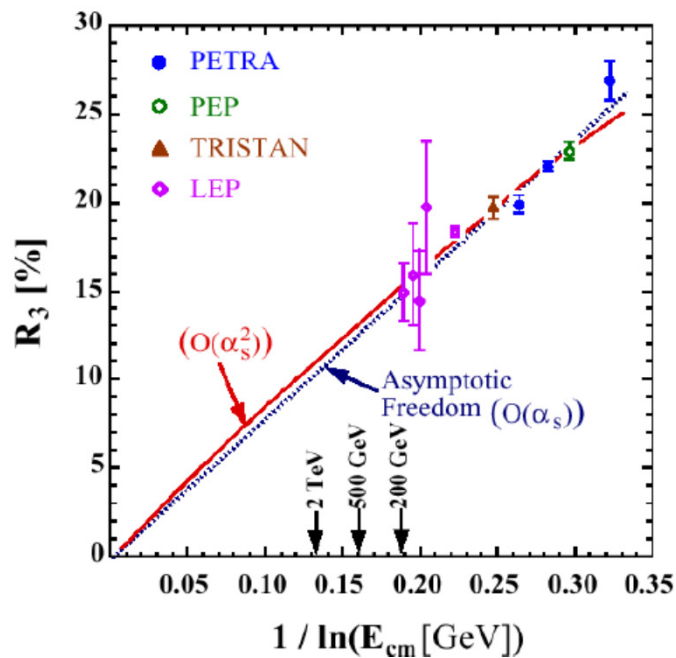

$R_3(y_{\text{cut}} = 0.08)$  [%]

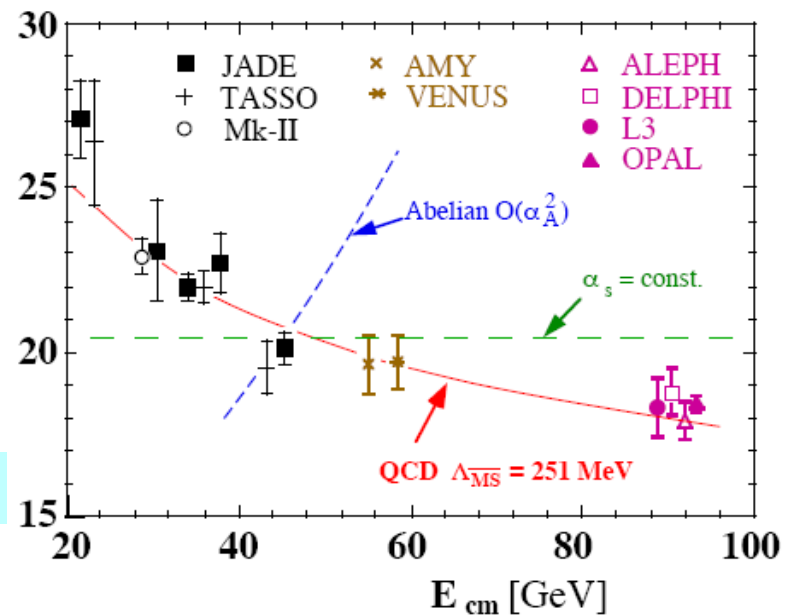

@TBA

# PQCD: Jets in $e^+e^-$ Collisions- XX

96

Is QCD really  $SU(3)$  ?

Test for non-Abelian couplings at LEP: 4 jets events

Special angular correlation from 3-gluon vertex amplitude

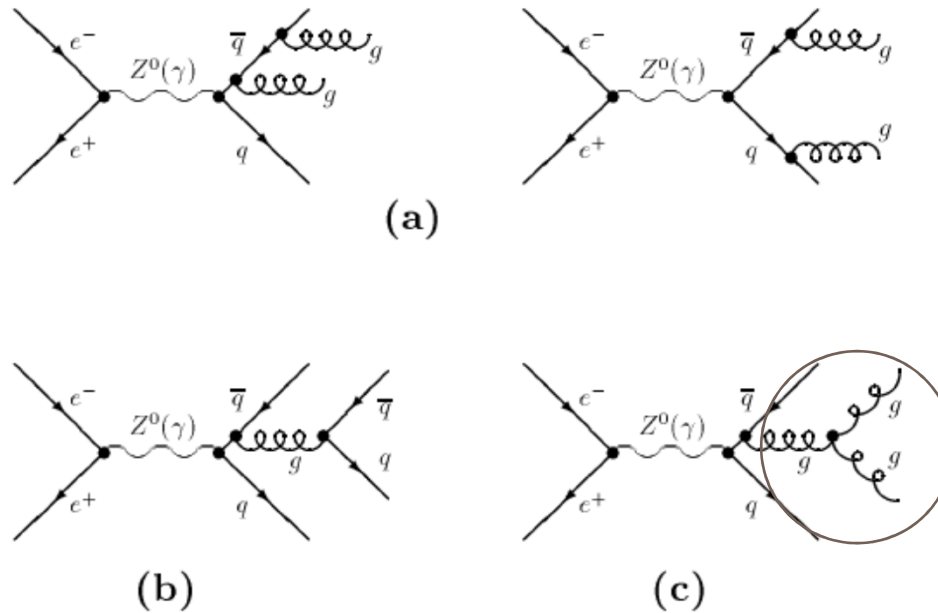

# PQCD: Jets in $e^+ e^-$ Collisions - XXI

97

Look at distribution of a special angle, sensitive to non-Abelian couplings:

Bengtson-Zerwas angle between  
energy-ordered jet axes  
( $E_1 \cong E_2 \cong E_3 \cong E_4$ )

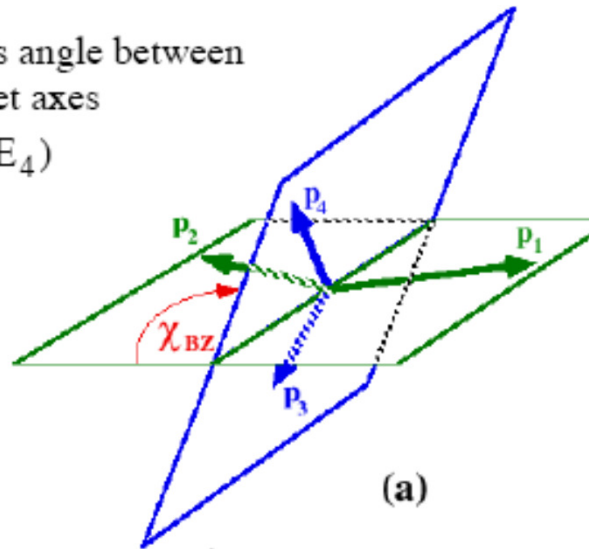

@TBA

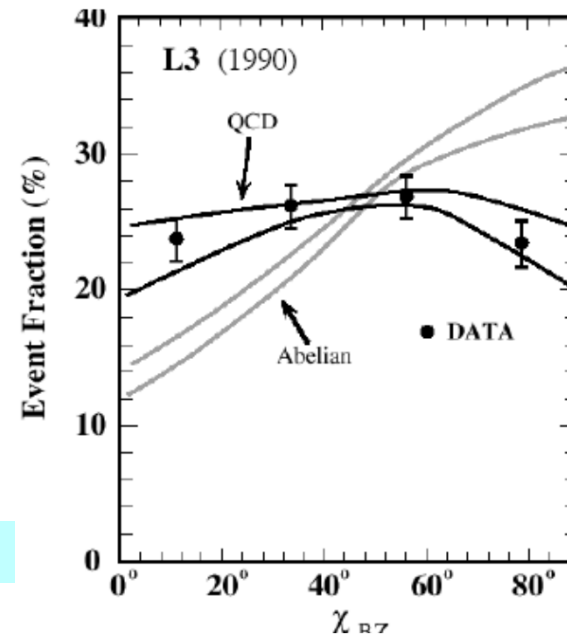

# Quark Parton Model - I

98

Write down  $F_2$  in terms of PDFs

$$\frac{F_2(x)}{x} = \sum_i z_i^2 n_i \delta\left(x - \frac{m_i}{M}\right) \rightarrow \frac{F_2(x)}{x} = \sum_i z_i^2 \underbrace{q_i(x)}$$

$$p = uud$$

$$F_2^p(x) = x \left[ \left(\frac{2}{3}\right)^2 u_p(x) + \left(-\frac{1}{3}\right)^2 d_p(x) \right]$$

$$\rightarrow F_2^p(x) = x \left[ \frac{4}{9} u_p(x) + \frac{1}{9} d_p(x) \right]$$

$$n = ddu$$

$$F_2^n(x) = x \left[ \left(-\frac{1}{3}\right)^2 d_n(x) + \left(\frac{2}{3}\right)^2 u_n(x) \right]$$

From isospin symmetry:

$$F_2^n(x) = x \left[ \left(-\frac{1}{3}\right)^2 u_p(x) + \left(\frac{2}{3}\right)^2 d_p(x) \right]$$

$$\rightarrow F_2^n(x) = x \left[ \frac{1}{9} u_p(x) + \frac{4}{9} d_p(x) \right]$$

# Quark Parton Model - II

99

Consider the deuteron structure function:

$$\begin{aligned} F_2^d(x) &= \frac{1}{2}(F_2^p + F_2^n) = \frac{5}{9}x[u_p(x) + d_p(x)] \\ &\rightarrow F_2^n(x) = F_2^d(x) - F_2^p(x) \\ &= \frac{5}{18}x[u_p(x) + d_p(x)] - \frac{1}{9}x[u_p(x) - 4d_p(x)] \\ &= \frac{3}{18}x[u_p(x) - d_p(x)] \end{aligned}$$

Finally extract PDFs from measured  $F_2$

$$xu_p(x) = xd_n(x) = 3F_2^p(x) - \frac{6}{5}F_2^d(x)$$

$$xu_n(x) = xd_p(x) = 3F_2^n(x) + \frac{24}{5}F_2^d(x)$$

# Quark Parton Model - III

100

Take a Hydrogen atom:

Common wisdom: “A bound state of proton + electron”

But: Consider the effect of radiative corrections (e.g. loops)

Then we should be more precise:

Hydrogen = (Proton+Electron)<sub>Valence</sub> + (Positrons+Electrons+Photons)<sub>Sea</sub>

Can we say valence and sea particles are fundamentally different? Well,...

*In a bound state, both are off mass shell*

*Both are active in yielding measurable effects (Coulomb levels vs. Lamb shift,..)*

*Sea particles yield small corrections to levels determined by valence e+p*

Take a hadron:

Hadron = (Quarks/Antiquarks)<sub>Valence</sub> + (Quarks/Antiquarks+Gluons)<sub>Sea</sub>

Since  $a_s \gg a$ , *sea effects are much larger in QCD*



# Quark Parton Model - IV

101

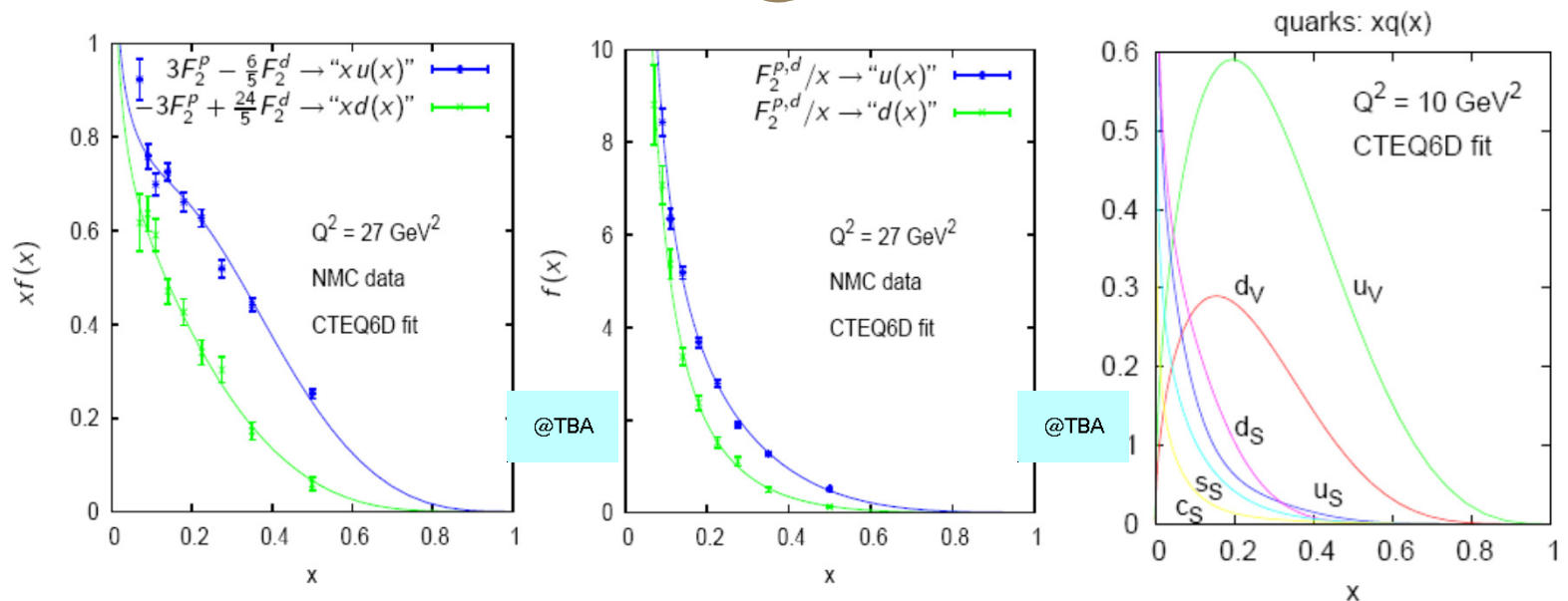

Among parton model predictions: *Sum Rules* (= Integral relations) for PDFs

Examples: Proton quark content is  $uud$

$$\int [u_p(x) - \bar{u}_p(x)] dx = 2$$

$$\int [d_p(x) - \bar{d}_p(x)] dx = 1$$

$$\int [s_p(x) - \bar{s}_p(x)] dx = 0$$

# PQCD: DIS Scaling Violations - I

102

Our picture of structure functions

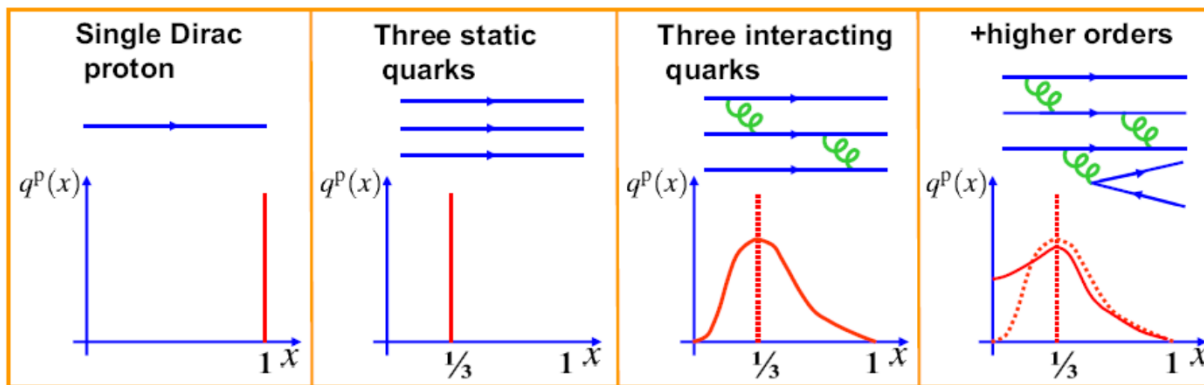

@TBA

Observe small deviations from scaling:  $F_2(x) \rightarrow F_2(x, Q^2)$

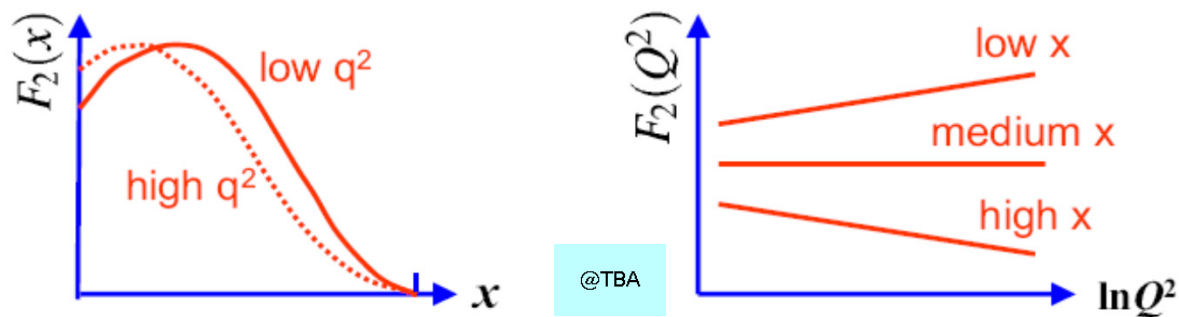

@TBA

# PQCD: DIS Scaling Violations - II

103

*QCD* on  $F_2(x, Q^2)$ :

$x$  – dependence  $\rightarrow$  Non perturbative  $\rightarrow$  Not predicted

$Q^2$  – dependence  $\rightarrow$  Perturbative  $\rightarrow$  Predicted !

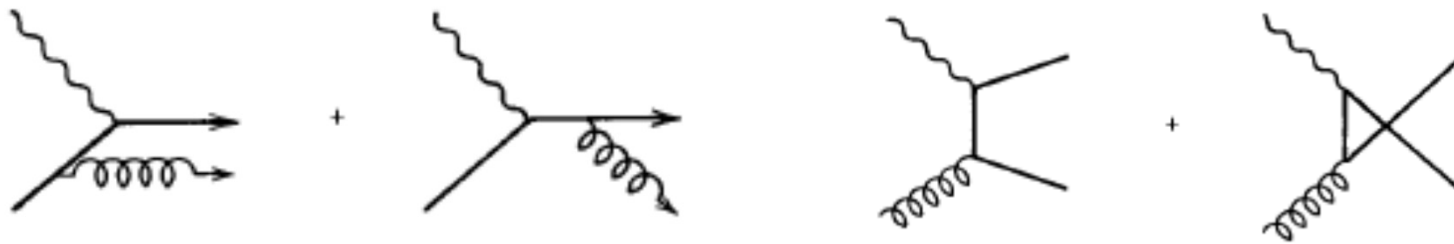

Dokshitzer-Gribov-Lipatov-Altarelli-Parisi (DGLAP) Equations:

Successful prediction of  $Q^2$  evolution of structure functions

# PQCD: DIS Scaling Violations - III

First order (NLO) QCD corrections to naive Quark Parton Model:

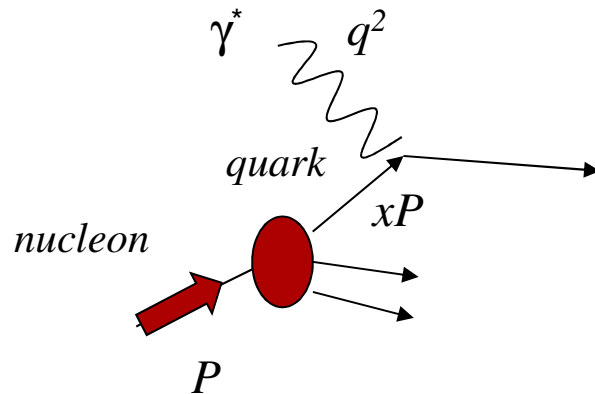

QPM

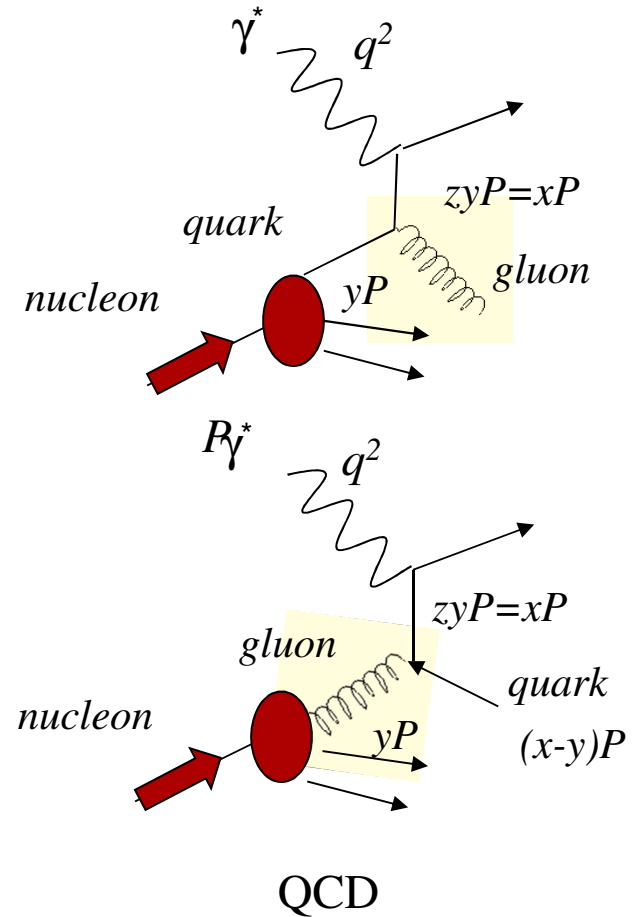

QCD

# PQCD: DIS Scaling Violations - IV

105

The bottom line:

Measured structure functions at any given Bjorken  $x$  depend on quark & gluon densities taken at higher fractional momentum  $y > x$

This originates a slow  $Q^2$  dependence

Core physics: Probabilities of QCD radiative/scattering processes  $P_{qq}(x/y)$ ,  $P_{gq}(x/y)$

Usually called *splitting functions*

$$\frac{F_2(x)}{x} = 2F_1(x) = \sum_i e_i^2 q_i(x)$$

$$\rightarrow \frac{F_2(x)}{x} = \sum_i e_i^2 \int_0^1 q_i(y) \delta(x-y) dy$$

$$\rightarrow \frac{F_2(x)}{x} = \sum_i e_i^2 \int_0^1 q_i(y) \delta\left(1 - \frac{x}{y}\right) \frac{dy}{y}$$

$$z = \frac{x}{y}$$

$$\rightarrow \frac{F_2(x)}{x} = \sum_i e_i^2 \int_0^1 q_i(y) \left[ \delta\left(1 - \frac{x}{y}\right) + \sigma_{qq}(z) \right] \frac{dy}{y} \quad \text{QCD corrections}$$

Quark-Parton Model

Reminder:

$$\delta(-x) = \delta(x), \quad \delta[a(1-x)] = \frac{1}{a} \delta(1-x)$$

$$\rightarrow \delta(x-y) = \delta\left[y\left(1 - \frac{x}{y}\right)\right] = \frac{1}{y} \delta\left(1 - \frac{x}{y}\right)$$

# PQCD: DIS Scaling Violations - V

Just as an example: Gluon radiation splitting function at leading order (LO)  
 Almost carbon-copy of Compton effect

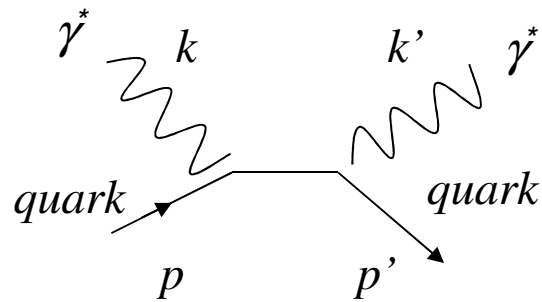

$$\gamma^*(k) q(p) \rightarrow \gamma^*(k') q(p')$$

$$k \leftrightarrow q$$

$$k' \leftrightarrow p'$$

$$u = (k-p')^2 \quad t = (q-p')^2$$

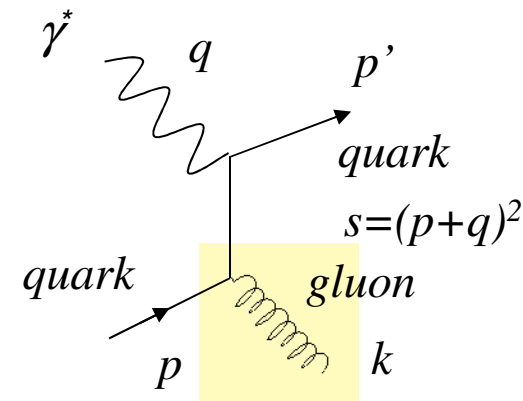

$$\gamma^*(q) q(p) \rightarrow q(p') g(k)$$

$$\left( \frac{d\sigma}{d\Omega} \right)_{\gamma q \rightarrow \gamma q} = \frac{\alpha^2 e_q^2}{2s} \left( \frac{-u}{s} - \frac{s}{u} - \frac{2tq^2}{su} \right)$$

$$\left( \frac{d\sigma}{d\Omega} \right)_{\gamma q \rightarrow gq} = \frac{C_F \alpha \alpha_s e_q^2}{2s} \left( \frac{-t}{s} - \frac{s}{t} - \frac{2uq^2}{st} \right)$$

# PQCD: DIS Scaling Violations - VI

107

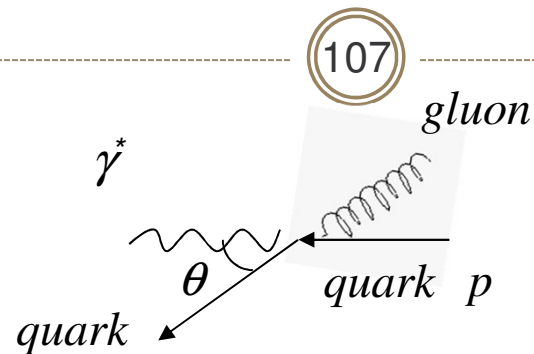

$$dp_T^2 = d(p^2 \sin^2 \theta) = 2p^2 \sin \theta \underbrace{\cos \theta}_{\approx 1} d\theta = 2p^2 d(\cos \theta)$$

$$\rightarrow dp_T^2 = \frac{s}{2} d(\cos \theta) = \frac{s}{2} \frac{d\Omega}{4\pi} \rightarrow \frac{d\sigma}{d\Omega} = \frac{s}{8\pi} \frac{d\sigma}{dp_T^2} \rightarrow \frac{d\sigma}{dp_T^2} = \frac{8\pi}{s} \frac{d\sigma}{d\Omega}$$

Reminder (Bjorken) :  $x = -\frac{q^2}{2P \cdot q}$

Define:  $z = -\frac{q^2}{2p \cdot q} = -\frac{q^2}{s - q^2}$

$$\rightarrow \left( \frac{d\sigma}{dp_T^2} \right)_{\gamma q \rightarrow gq} \propto \frac{C_F \alpha_s e_q^2}{p_T^2} P_{qq}(z), \quad P_{qq}(z) \equiv \frac{1+z^2}{1-z^2}$$

# PQCD: DIS Scaling Violations - VII

108

Integrate 'Compton-like' differential cross-section between:

$\lambda$  lower cutoff ( $\leftarrow$  no divergences),  $\frac{\hat{s}}{4}$  upper cutoff ( $\leftarrow$  kinematical),  $\hat{s}$  partonic CM energy squared

$$\sigma_{qq}(z) = \int_{\lambda}^{p_T^2 \max = \frac{\hat{s}}{4}} \frac{d\sigma}{dp_T^2} dp_T^2 \propto \frac{C_F \alpha \alpha_S e_q^2}{s} P_{qq}(z) \ln \left( -\frac{q^2}{\lambda} \right)$$

$$\text{Redefine : } P_{qq}(z) \equiv \frac{\alpha e_q^2 C_F}{2\pi s} \frac{1+z^2}{1-z^2} \rightarrow \frac{F_2(x)}{x} = \sum_i e_i^2 \int_x^1 q_i(y) \left[ \delta \left( 1 - \frac{x}{y} \right) + \frac{\alpha_S}{2\pi} P_{qq}(z) \ln \left( \frac{Q^2}{\lambda} \right) \right] \frac{dy}{y}$$

$$\rightarrow \frac{F_2(x)}{x} = \sum_i e_i^2 \underbrace{\left[ q_i(x) + \int_x^1 q_i(y) \frac{\alpha_S}{2\pi} \ln \left( \frac{Q^2}{\lambda} \right) P_{qq} \left( \frac{x}{y} \right) \frac{dy}{y} \right]}_{q_i(x, Q^2)}$$

$$q_i(x, Q^2) = q_i(x) + \underbrace{\int_x^1 q_i(y) \frac{\alpha_S}{2\pi} \ln \left( \frac{Q^2}{\lambda} \right) P_{qq} \left( \frac{x}{y} \right) \frac{dy}{y}}_{\Delta q_i(x, Q^2)}$$

$$\rightarrow \Delta q_i(x, Q^2) = q_i(x, Q^2) - q_i(x) = \int_x^1 q_i(y) \frac{\alpha_S}{2\pi} \underbrace{(\ln Q^2 - \ln \lambda)}_{\Delta \ln Q^2} P_{qq} \left( \frac{x}{y} \right) \frac{dy}{y}$$

$$\rightarrow \frac{\Delta q_i(x, Q^2)}{\Delta \ln Q^2} = \int_x^1 q_i(y) \frac{\alpha_S}{2\pi} P_{qq} \left( \frac{x}{y} \right) \frac{dy}{y}$$



# PQCD: DIS Scaling Violations -VIII

109

Evolution equation for each quark flavor:

$$\frac{dq_i(x, Q^2)}{d \ln(Q^2)} = \int_x^1 q_i(y, Q^2) \frac{\alpha_s}{2\pi} P_{qq} \left( \frac{x}{y} \right) \frac{dy}{y}$$

Observe: Since  $q_i(x) \rightarrow q_i(x, Q^2)$ , the evolution equation should involve  $q_i(x, Q^2)$ , rather than  $q_i(x)$ , under the integral symbol

This is actually incomplete:

We forgot to add the contribution from the 2nd diagram..

$$\rightarrow \frac{dq(x, Q^2)}{d \ln(Q^2)} = \frac{\alpha_s(Q^2)}{2\pi} \int_x^1 \left[ q(y, Q^2) P_{qq} \left( \frac{x}{y} \right) + g(y, Q^2) P_{gq} \left( \frac{x}{y} \right) \right] \frac{dy}{y}$$

And there is another equation for the evolution of the *gluon* density:

$$\frac{dg(x, Q^2)}{d \ln(Q^2)} = \frac{\alpha_s(Q^2)}{2\pi} \int_x^1 \left[ \sum_i q_i(y, Q^2) P_{qg} \left( \frac{x}{y} \right) + g(y, Q^2) P_{gg} \left( \frac{x}{y} \right) \right] \frac{dy}{y}$$

*Altarelli - Parisi*, or *DGLAP*, equations for the parton densities:

Integro-Differential equations for the  $Q^2$  evolution of the parton densities

# PQCD: DIS Scaling Violations -IX

110

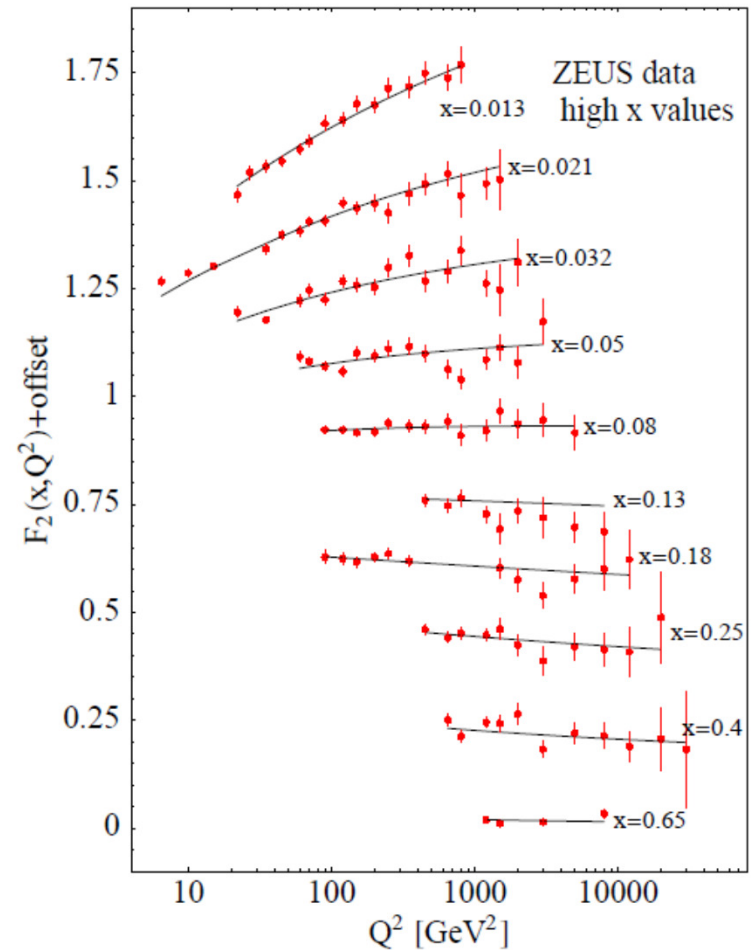
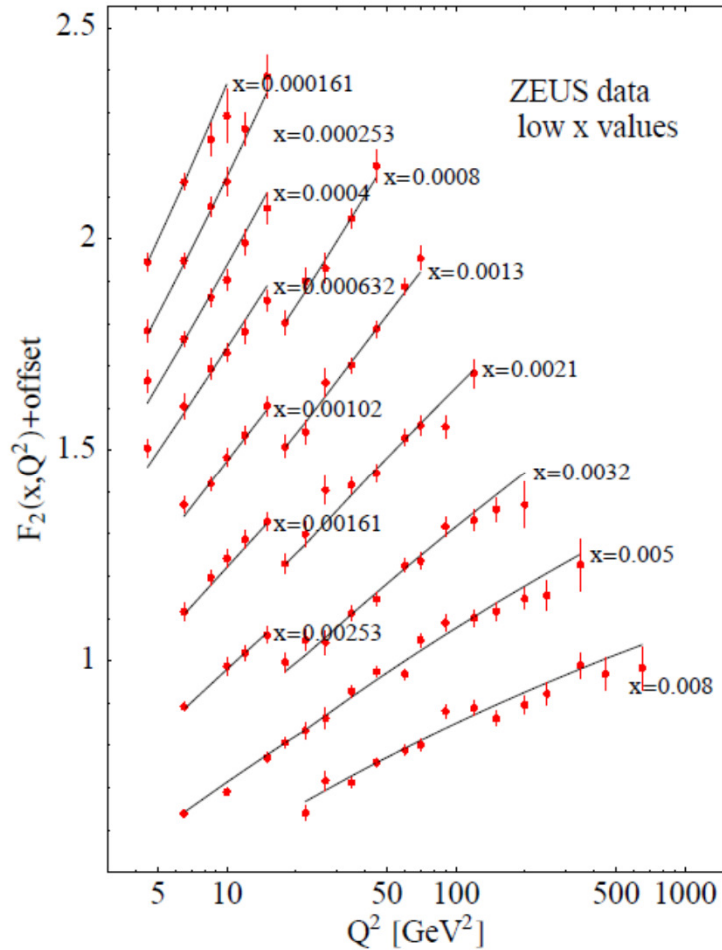

# PQCD: DIS Scaling Violations -X

111

PDF Evolution with  $Q^2$

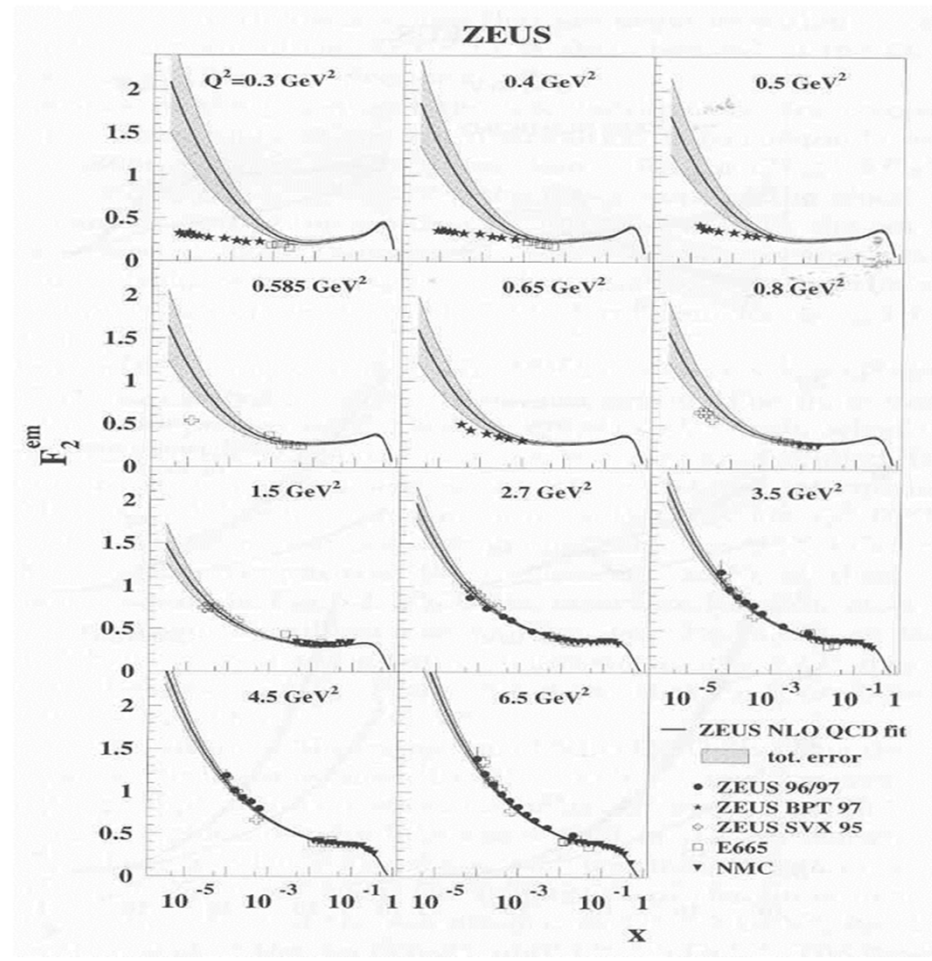

# Hadron Collisions - I

112

Historically best observed and studied at hadron colliders

ISR = Intersecting Storage Ring (CERN '70s)

pp 31 GeV / beam

Spp̄S = Super pp̄ Synchrotron (CERN '80s)

pp̄ 270-310 GeV / beam

Tevatron (Fermilab early '90s - 2011)

pp̄ 1 TeV / beam

RHIC = Relativistic Heavy Ion Collider (BNL 3<sup>rd</sup> Millennium)

ions 200 GeV / nucleon \* beam

LHC = Large Hadron Collider (CERN 3<sup>rd</sup> Millennium)

pp 7 TeV / beam (presently 4 TeV)

ions 2.7 TeV / nucleon \* beam

# Hadron Collisions - II

113

CM frame: usually identical to LAB

Important exception: ISR (collision angle  $15^\circ$ )

Not relevant for LHC (collision angle  $0.01^\circ$ )

But: Partonic collision CM  $\neq$  Event CM

→  $E_{top}$   $p$  of parton collision unknown

→ Initial state only partially known

→ Separate collision kinematics into:

*Transverse*

*Longitudinal*

Introduce useful kinematical variables: *Rapidity*, *Transverse momentum*

# Hadron Collisions - III

114

Lorentz transformation  $S \rightarrow S'(\beta)$ :

$$\begin{pmatrix} z' \\ t' \end{pmatrix} = \begin{pmatrix} \gamma & -\gamma\beta \\ -\gamma\beta & \gamma \end{pmatrix} \begin{pmatrix} z \\ t \end{pmatrix} = \begin{pmatrix} \frac{1}{\sqrt{1-\beta^2}} & -\frac{\beta}{\sqrt{1-\beta^2}} \\ -\frac{\beta}{\sqrt{1-\beta^2}} & \frac{1}{\sqrt{1-\beta^2}} \end{pmatrix} \begin{pmatrix} z \\ t \end{pmatrix}$$

Compare:

$$\gamma^2 - \gamma^2\beta^2 = \frac{1}{1-\beta^2} - \frac{\beta^2}{1-\beta^2} = 1 \Leftrightarrow \cosh^2 y - \sinh^2 y = 1$$

$$\rightarrow \begin{cases} \gamma = \cosh y \\ \beta\gamma = \sinh y \end{cases} \rightarrow \beta = \tanh y, \quad y \text{ rapidity}$$

$$\rightarrow \begin{pmatrix} z' \\ t' \end{pmatrix} = \begin{pmatrix} \cosh y & -\sinh y \\ -\sinh y & \cosh y \end{pmatrix} \begin{pmatrix} z \\ t \end{pmatrix}$$

→ Another way of writing a Lorentz transformation:  $y$  instead of  $\beta, \gamma$

# Hadron Collisions - IV

115

Split off longitudinal/transverse momentum components:

$$E^2 = m^2 + |\mathbf{p}|^2$$

$$|\mathbf{p}|^2 = p_{\parallel}^2 + p_{\perp}^2$$

$$\rightarrow E^2 = m^2 + p_{\parallel}^2 + p_{\perp}^2 = m_{\perp}^2 + p_{\parallel}^2, \quad m_{\perp}^2 = m^2 + p_{\perp}^2 \quad \text{transverse mass}$$

$$\rightarrow \left(\frac{E}{m_{\perp}}\right)^2 - \left(\frac{p_{\parallel}}{m_{\perp}}\right)^2 = 1$$

$$\rightarrow \begin{cases} E = m_{\perp} \cosh y \\ p_{\parallel} = m_{\perp} \sinh y \end{cases}$$

$$\rightarrow p_{\parallel} = E \tanh y$$

$$\rightarrow \begin{pmatrix} p_{\parallel}' \\ E' \end{pmatrix} = \begin{pmatrix} \cosh y & -\sinh y \\ -\sinh y & \cosh y \end{pmatrix} \begin{pmatrix} p_{\parallel} \\ E \end{pmatrix}$$

# Hadron Collisions - V

116

Most important properties:

Rapidity is *additive* under Lorentz boosts

Transverse momentum is *invariant* under Lorentz boosts

$$\begin{cases} E = m_{\perp} \cosh y \\ p_{\parallel} = m_{\perp} \sinh y \end{cases} \rightarrow \frac{p_{\parallel}}{E} = \tanh y = \frac{e^y - e^{-y}}{e^y + e^{-y}} = \frac{e^{2y} - 1}{e^{2y} + 1}$$

$$\rightarrow \frac{p_{\parallel}}{E} (e^{2y} + 1) = e^{2y} - 1 \rightarrow e^{2y} \left( \frac{p_{\parallel}}{E} - 1 \right) = - \left( 1 + \frac{p_{\parallel}}{E} \right) \rightarrow e^{2y} = \frac{1 + \frac{p_{\parallel}}{E}}{1 - \frac{p_{\parallel}}{E}}$$

$$\rightarrow y = \frac{1}{2} \ln \frac{E + p_{\parallel}}{E - p_{\parallel}}$$

Boost along  $z$  by  $\beta, \gamma$

$$\rightarrow y' = \frac{1}{2} \ln \frac{\gamma(E + \beta p_{\parallel}) + \gamma(p_{\parallel} + \beta E)}{\gamma(E + \beta p_{\parallel}) - \gamma(p_{\parallel} + \beta E)}$$



# Hadron Collisions - VI

117

$$\rightarrow y' = \frac{1}{2} \ln \frac{(E + p_{\parallel})(1 + \beta)}{(E - p_{\parallel})(1 - \beta)} = \underbrace{\frac{1}{2} \ln \frac{(E + p_{\parallel})}{(E - p_{\parallel})}}_y + \underbrace{\frac{1}{2} \ln \frac{(1 + \beta)}{(1 - \beta)}}_{y_{boost}}$$

Indeed:

$$y \rightarrow y' = y + y_{boost}$$

$$\rightarrow dy' = dy, \quad \Delta y' = \Delta y$$

Consistency check:

For momentum along  $z$

$$y = \frac{1}{2} \ln \frac{E + p}{E - p} = \frac{1}{2} \ln \frac{\gamma m + \beta \gamma m}{\gamma m - \beta \gamma m} = \frac{1}{2} \ln \frac{1 + \beta}{1 - \beta}$$

$$\rightarrow \frac{1 + \beta}{1 - \beta} = e^{2y} \rightarrow 1 + \beta = (1 - \beta) e^{2y} \rightarrow \beta(1 + e^{2y}) = e^{2y} - 1$$

$$\rightarrow \beta = \frac{e^{2y} - 1}{e^{2y} + 1} = \tanh y$$

$$\rightarrow \gamma = \cosh y \rightarrow \text{OK}$$

# Hadron Collisions - VII

118

Pseudo-rapidity  $\eta$ :

$$y = \frac{1}{2} \ln \frac{E + p_{\parallel}}{E - p_{\parallel}} \approx \frac{1}{2} \ln \frac{1 + \cos \theta}{1 - \cos \theta} = -\frac{1}{2} \ln \frac{1 - \cos \theta}{1 + \cos \theta} = -\frac{1}{2} \ln \frac{\sin^2 \theta/2}{\cos^2 \theta/2}$$

$$\rightarrow y \approx -\frac{1}{2} \ln(\tan^2 \theta/2) = -\ln(\tan \theta/2) = \eta$$

1-to-1 correspondance to polar angle

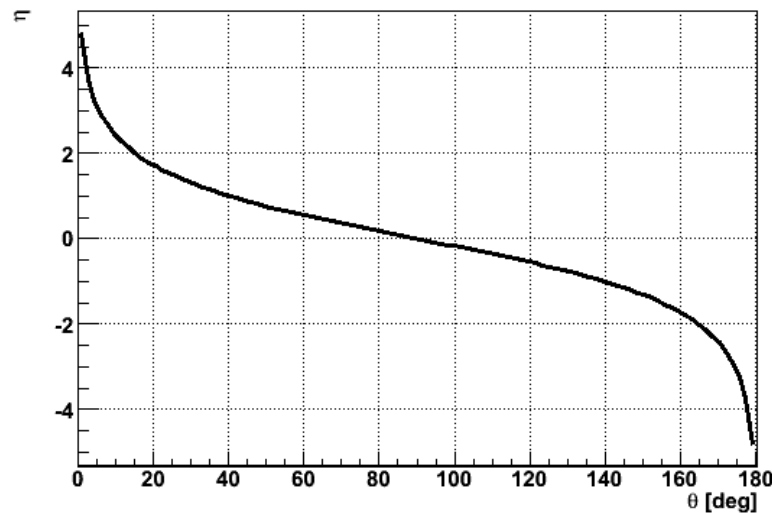

# Hadron Collisions - VIII

119

Interesting processes: *Inclusive*

Ex: Inclusive production of  $c$   $a + b \rightarrow c + X$

→ Inclusive, invariant cross-sections

Reminder:  $\frac{d^3\mathbf{P}}{E}$  Lorentz invariant quantity

Elementary volume (impulse space):

Same as cylindrical coordinate space

$$d^3\mathbf{r} = r dr dz d\varphi \rightarrow d^3\mathbf{P} = P_T dP_T dP_{\parallel} d\varphi \rightarrow \frac{d^3\mathbf{P}}{E} = \frac{P_T dP_T dP_{\parallel} d\varphi}{E}$$

$$dy = \frac{dP_{\parallel}}{E} \rightarrow \frac{d^3\mathbf{P}}{E} = dy P_T dP_T d\varphi$$

→ Azimuthal integral:

$$\int_{\varphi=0}^{\varphi=2\pi} \frac{d^3\mathbf{P}}{E} = \int_{\varphi=0}^{\varphi=2\pi} (dy P_T dP_T) d\varphi = 2\pi dy P_T dP_T = 2\pi dy \frac{1}{2} d(P_T^2) = \pi dy d(P_T^2)$$

→ Inclusive, invariant differential cross-section:  $\frac{d\sigma}{d^3\mathbf{P}} = E \frac{d\sigma}{d^3\mathbf{P}} = \frac{1}{\pi} \frac{d\sigma}{dy d(P_T^2)} \equiv \frac{1}{2\pi P_T} \frac{d\sigma}{dy dP_T}$

# Hadron Collisions - IX

120

Introducing pseudorapidity, transverse energy components of 4-momentum:

$$E_T = m_{\perp} \rightarrow \begin{matrix} E = E_T \cosh y \\ p_{\parallel} = E_T \sinh y \end{matrix} \rightarrow E_T = \frac{E}{\cosh y}, \quad y \approx \eta = -\ln(\tan \theta/2)$$

$$\frac{\sinh y}{\cosh y} = \tanh y = \frac{\sqrt{\cosh^2 y - 1}}{\cosh y} \rightarrow \tanh^2 y = 1 - \frac{1}{\cosh^2 y} \rightarrow \frac{1}{\cosh y} = \sqrt{1 - \tanh^2 y} \rightarrow E_T = E \sqrt{1 - \tanh^2 y}$$

$$\rightarrow E_T \approx E \sqrt{1 - \tanh^2 \eta} = E \left( 1 - \frac{\frac{\cos \theta/2}{\sin \theta/2} - \frac{\sin \theta/2}{\cos \theta/2}}{\frac{\cos \theta/2}{\sin \theta/2} + \frac{\sin \theta/2}{\cos \theta/2}} \right)^{1/2} = E \left[ 1 - (\cos^2 \theta/2 - \sin^2 \theta/2) \right]^{1/2} = E \sin \theta$$

$$p = \left( E, \underbrace{P_x, P_y}_{P_T^2 = P_x^2 + P_y^2}, \underbrace{P_z}_{P_{\parallel} = P_z} \right)$$

$$E \approx P, E_T \approx P_T$$

$$\rightarrow p \approx \left( E_T \cosh \eta, \underbrace{E_T \sin \phi, E_T \cos \phi}_{E_T}, E_T \sinh \eta \right) \quad \text{Useful in clustering algorithms}$$

# Parton Kinematics - I

121

Partonic kinematics: Relevant for 'hard' collisions

Event CM frame:

$$\begin{cases} P_A = (E_A, 0, 0, p_A) \\ P_B = (E_A, 0, 0, -p_A) \end{cases} \quad \text{4-momenta incident particles}$$

$$\begin{cases} p_1 = x_1 P_A \\ p_2 = x_2 P_B \end{cases} \quad \text{4-momenta incident partons}$$

$$\beta_{CM} = \frac{x_1 - x_2}{x_1 + x_2} \quad \text{Parton CM speed as seen by event CM (= LAB for most colliders)}$$

$$x_F = x_1 - x_2 \quad \text{Parton Feynman } x$$

$$y = \frac{1}{2} \ln \frac{1 + \beta_{CM}}{1 - \beta_{CM}} = \frac{1}{2} \ln \frac{x_1}{x_2} \quad \text{Parton CM rapidity as seen by event CM}$$

$x_1, x_2$  varying on event-by-event basis

$\rightarrow \beta_{CM}, x_F, y$  not fixed, rather statistically distributed

Distribution depending on event type

# Parton Kinematics - II

122

*Hadronic, inclusive* cross sections for hard processes

$$A + B \rightarrow c + X$$

result from a convolution of *partonic, exclusive* cross sections

$$a + b \rightarrow c + X$$

at any given partonic CM energy  $\hat{s}$

$$\sigma_{A+B \rightarrow f+X} = \sum_{a,b} C_{ab} \int \sigma_{ab \rightarrow c+X} \left[ f_{a/A}(x_a) f_{b/B}(x_b) + (A \leftrightarrow B)_{b \neq a} \right] dx_a dx_b$$

with PDF over full range of  $(x_1, x_2)$

$$\sigma_{ab \rightarrow c+X} \begin{cases} \text{total/differential in the final state } c \\ \text{summed over initial, final colors} \end{cases}$$

$C_{ab}$  color-averaging factor, different for  $qq$ ,  $q\bar{q}$ ,  $qg$ ,  $gg$

# Parton Kinematics - III

123

Partonic CM energy :

$$\sqrt{\hat{s}} = \sqrt{s x_a x_b}$$

Introduce  $\tau$ :

$$\tau = x_a x_b$$

Switching to  $x_a, \tau$  independent variables:

$$x_b = \frac{\tau}{x_a} \rightarrow dx_b = \frac{d\tau}{x_a}$$

→ Hadronic cross-section in terms of partonic subprocess contributions:

$$\sigma_{A+B \rightarrow f+X} = \sum_{a,b} C_{ab} \int_0^1 d\tau \int_{\tau}^1 \sigma_{ab \rightarrow c+X}(\hat{s}) \left[ f_{a/A}(x_a) f_{b/B}(\tau/x_a) + (A \leftrightarrow B)_{b \neq a} \right] \frac{dx_a}{x_a}$$

# Parton Kinematics - IV

124

→ Re-write cross-section as *differential* in  $\tau$ :

$$\frac{d\sigma_{A+B \rightarrow f+X}}{d\tau} = \sum_{a,b} \sigma_{ab \rightarrow c+X}(\hat{s}) \frac{dL_{ab}}{d\tau}$$

Introducing *differential luminosity* for parton collisions occurring within  $(\tau, \tau + d\tau)$ :

$$\frac{dL_{ab}}{d\tau} = C_{ab} \int_{\tau}^1 [f_{a/A}(x_a) f_{b/B}(\tau/x_a) + (A \leftrightarrow B)_{b \neq a}] \frac{dx_a}{x_a}$$

$$\rightarrow \frac{\tau}{\hat{s}} \frac{dL_{ab}}{d\tau} = \frac{1}{s} \frac{dL_{ab}}{d\tau} = \frac{dL_{ab}}{d\hat{s}}$$

Parton luminosities quite relevant  
to assess production rates:

Ex. Higgs at LHC

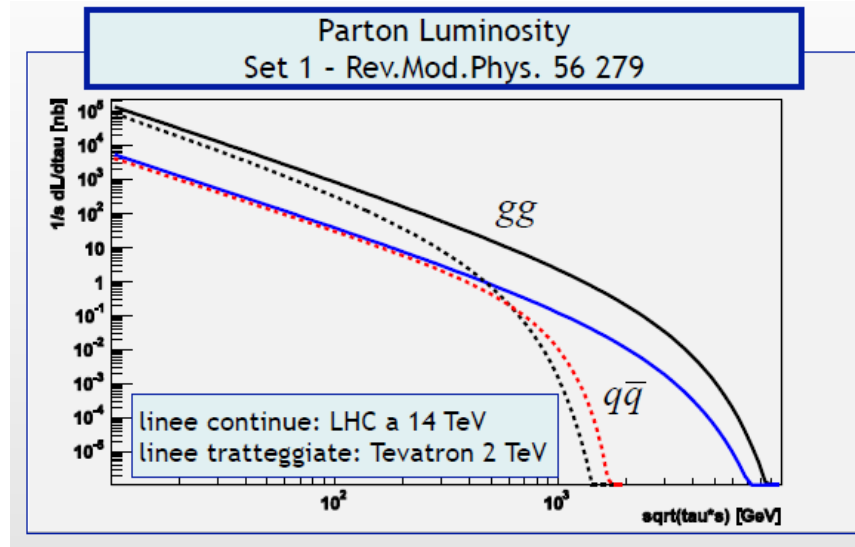



# Parton Kinematics - V

125

$\tau$  alone does not fix kinematics of the initial state: Use  $y$  Rapidity

$$\begin{cases} \tau = x_a x_b \\ y = \frac{1}{2} \ln \frac{x_a}{x_b} \end{cases} \rightarrow \begin{cases} x_a = \sqrt{\tau} e^y \\ x_b = \sqrt{\tau} e^{-y} \end{cases} \rightarrow \sqrt{\hat{s}} \equiv \sqrt{\tau s}, \quad dx_1 dx_2 = d\tau dy$$

For any given  $\tau$ :  $|y| < -\frac{1}{2} \ln \tau$

Re-write hadronic cross-section as *doubly differential* in both  $y, \tau$ :

$$\frac{d\sigma_{A+B \rightarrow c+X}}{dx_a dx_b} = \sum_{a,b} C_{ab} \sigma_{ab \rightarrow c+X} \left[ f_{a/A}(x_a) f_{b/B}(x_b) + (A \leftrightarrow B)_{b \neq a} \right] = \frac{d\sigma}{d\tau dy}$$

Ex. : *Central production*:

$$y = 0 \rightarrow x_a = x_b = \sqrt{\tau} \rightarrow \left. \frac{d\sigma}{d\tau dy} \right|_{y=0} = \sum_{a,b} C_{ab} \sigma_{ab \rightarrow c+X} \left[ f_{a/A}(\sqrt{\tau}) f_{b/B}(\sqrt{\tau}) + (A \leftrightarrow B)_{b \neq a} \right]$$

Ex. : *Threshold production*

$$\sqrt{\tau} = \frac{m_c}{\sqrt{s}}$$

# Parton Kinematics - VI

126

Examples of rapidity distribution: Threshold  $t\bar{t}$ ,  $b\bar{b}$  production at Tevatron, LHC

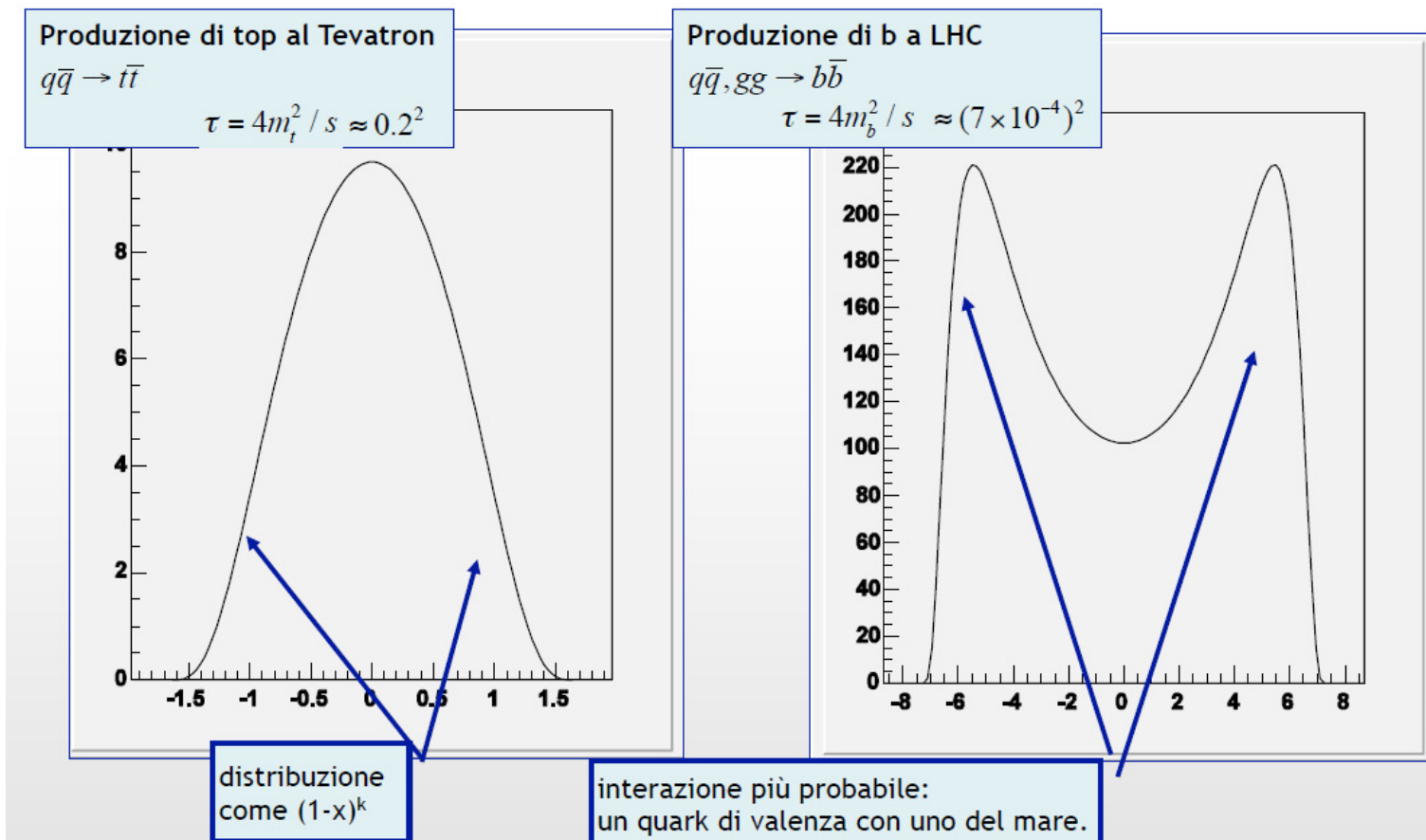

# PQCD: Drell-Yan - I

127

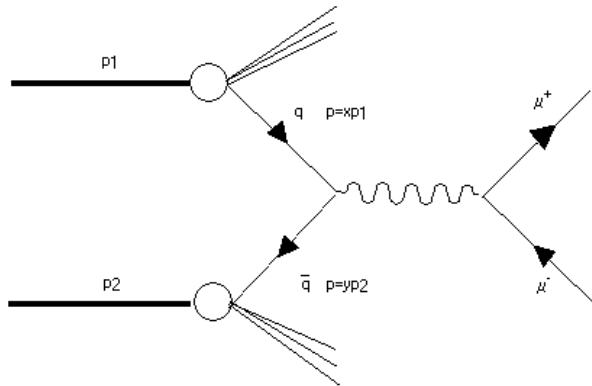

Angular distribution in the pair rest frame

Expect  $\propto 1 + \cos^2 \theta^*$  as usual for Fermion-Antifermion

$$\frac{d\sigma(q\bar{q} \rightarrow l^+l^-)}{dq^2} = \frac{4\pi\alpha^2}{3q^2} e_q^2 \delta(q^2 - s_{q\bar{q}})$$

$x_1, x_2$  Bjorken  $x$  for  $q, \bar{q}$

$$s_{q\bar{q}} = (p_q + p_{\bar{q}})^2 = (x_1 p_1 + x_2 p_2)^2 \simeq x_1 x_2 s$$

$$\sigma(q\bar{q} \rightarrow l^+l^-) = \frac{4\pi\alpha^2}{3q^2} e_q^2, \quad e_q = \text{quark charge in } e \text{ units}$$

$$s_{q\bar{q}} = M_{\mu\mu}^2 = \tau s$$

Parton model: Pure QED process

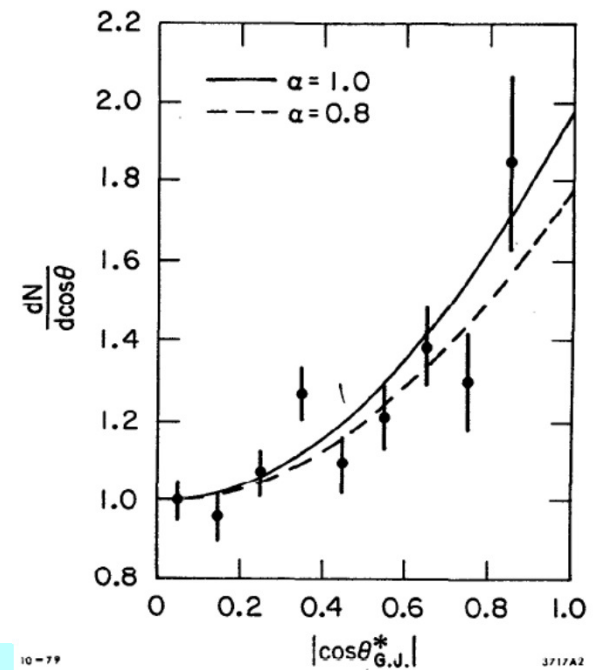

10-79

@TBA

3717A2

# PQCD: Drell – Yan - II

128

Reverse  $e^+e^- \rightarrow q\bar{q}$  process:  $q\bar{q} \rightarrow e^+e^-$

Obtained by any reaction

hadron + hadron  $\rightarrow l^+ l^- + X$

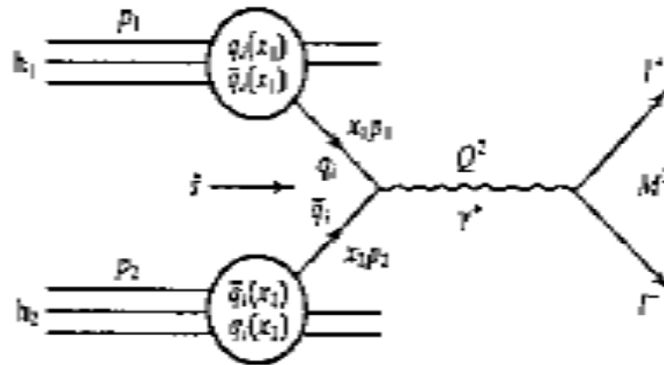

Ignore parton transverse momentum

Ignore non-annihilating partons (  $\rightarrow$  "spectators")

Ignore parton fragmentation

# PQCD: Drell – Yan - III

129

$$e^+e^- \rightarrow \mu^+\mu^- :$$

$$\frac{d\sigma}{d\Omega^*} = \frac{\alpha^2}{4s} (1 + \cos^2 \theta^*)$$

$$\sigma = \frac{4\pi\alpha^2}{3s}$$

$$q\bar{q} \rightarrow \mu^+\mu^- :$$

$$\frac{d\sigma_q}{d\Omega^*} = \frac{Q_q^2\alpha^2}{4M^2} (1 + \cos^2 \theta^*) \cdot \frac{1}{3}$$

$Q_q$ : Quark charge

$\frac{1}{3}$ : Color factor

$M^2$ :  $\mu^+\mu^-$  invariant mass = Total energy in partonic CM

# PQCD: Drell – Yan - IV

130

$$p_1 = x_1 P_1 \simeq x_1 (E, 0, 0, P)$$

$$p_2 = x_2 P_2 \simeq x_2 (E, 0, 0, -P)$$

$$q = x_1 P_1 + x_2 P_2 \simeq [(x_1 + x_2)E, 0, 0, (x_1 - x_2)P]$$

$$M^2 = q^2 \simeq (x_1 + x_2)^2 E^2 - (x_1 - x_2)^2 P^2 \simeq 4x_1 x_2 E^2 = x_1 x_2 s \equiv \tau s$$

Switch to more useful kinematical variables:

Either

$$\left\{ \begin{array}{l} x_F \equiv x_1 - x_2 = \pm \frac{2|\mathbf{q}|}{\sqrt{s}} \quad \text{Feynman } x \text{ of parton pair} \\ M^2 = s x_1 x_2 \end{array} \right.$$

Or:

$$\left\{ \begin{array}{l} y = \frac{1}{2} \ln \frac{E + p_3}{E - p_3} \simeq \frac{1}{2} \ln \frac{x_1}{x_2} \quad \text{Rapidity of parton pair (neglecting rest mass)} \\ M = \sqrt{s x_1 x_2} \end{array} \right.$$

# PQCD: Drell – Yan - V

131

Inclusive cross-section:

Contribution by parton pair with  $(x_1, x_2)$  fractional momenta

$$d^2\sigma(pp \rightarrow \mu^+\mu^- + X) = \frac{4\pi\alpha^2}{9M^2} \sum_q Q_q^2 [f_q(x_1)f_{\bar{q}}(x_2) + f_q(x_2)f_{\bar{q}}(x_1)] dx_1 dx_2$$

$$\begin{cases} y = \frac{1}{2} \ln \frac{E + p_3}{E - p_3} \simeq \frac{1}{2} \ln \frac{x_1}{x_2} \rightarrow x_1 = x_2 e^{2y} \\ M = \sqrt{s x_1 x_2} \rightarrow M = \sqrt{s x_2 e^{2y} x_2} \rightarrow x_2 = \frac{M}{\sqrt{s}} e^{-y}, x_1 = \frac{M}{\sqrt{s}} e^{+y} \end{cases}$$

$$dx_1 dx_2 = J dM dy$$

$$J = \frac{\partial(x_1, x_2)}{\partial(M, y)} = \begin{vmatrix} \frac{\partial x_1}{\partial M} & \frac{\partial x_1}{\partial y} \\ \frac{\partial x_2}{\partial M} & \frac{\partial x_2}{\partial y} \end{vmatrix} = \frac{\partial x_1}{\partial M} \frac{\partial x_2}{\partial y} - \frac{\partial x_1}{\partial y} \frac{\partial x_2}{\partial M}$$

$$\rightarrow J = \frac{1}{\sqrt{s}} e^{+y} \left( -\frac{M}{\sqrt{s}} e^{-y} \right) - \frac{M}{\sqrt{s}} e^{+y} \frac{1}{\sqrt{s}} e^{-y} = -\frac{2M}{s} = -2\sqrt{\frac{x_1 x_2}{s}} \rightarrow dx_1 dx_2 = \left( -2\sqrt{\frac{x_1 x_2}{s}} \right) dM dy$$

# PQCD: Drell – Yan - VI

132

$$\rightarrow d^2\sigma = \frac{4\pi\alpha^2}{9M^2} \left| -2\sqrt{\frac{x_1 x_2}{s}} \right| \sum_q Q_q^2 [f_q(x_1) f_{\bar{q}}(x_2) + f_q(x_2) f_{\bar{q}}(x_1)] dM dy$$

$$s\tau = M^2 \rightarrow M = \sqrt{s\tau}$$

$$\rightarrow \frac{d^2\sigma}{dM dy} = \frac{8\pi\alpha^2}{9M^2} \frac{\tau}{M} \sum_q Q_q^2 [f_q(x_1) f_{\bar{q}}(x_2) + f_q(x_2) f_{\bar{q}}(x_1)]$$

$$\rightarrow \frac{d^2\sigma}{dM dy} = \frac{8\pi\alpha^2}{9Ms} \sum_q Q_q^2 [f_q(x_1) f_{\bar{q}}(x_2) + f_q(x_2) f_{\bar{q}}(x_1)]$$

Central events:

$$y = 0, x_1 = x_2 = \sqrt{\tau}$$

$$\rightarrow \left. \frac{d^2\sigma}{dM dy} \right|_{y=0} = \frac{8\pi\alpha^2}{9Ms} \sum_q Q_q^2 [f_q(\sqrt{\tau}) f_{\bar{q}}(\sqrt{\tau}) + f_q(\sqrt{\tau}) f_{\bar{q}}(\sqrt{\tau})]$$

$$\rightarrow s^{3/2} \left. \frac{d^2\sigma}{dM dy} \right|_{y=0} = \frac{8\pi\alpha^2}{9} \frac{1}{\sqrt{\tau}} \sum_q Q_q^2 [f_q(\sqrt{\tau}) f_{\bar{q}}(\sqrt{\tau}) + f_q(\sqrt{\tau}) f_{\bar{q}}(\sqrt{\tau})]$$



# PQCD: Drell – Yan - VII

133

$$M = \sqrt{s\tau} \rightarrow dM = \sqrt{s}d(\sqrt{\tau})$$

$$\rightarrow s^{3/2} \frac{d^2\sigma}{dMdy} \Big|_{y=0} = s^{3/2} \frac{d^2\sigma}{\sqrt{s}d(\sqrt{\tau})dy} \Big|_{y=0} = s \frac{d^2\sigma}{d(\sqrt{\tau})dy} \Big|_{y=0}$$

$$\rightarrow s \frac{d^2\sigma}{d(\sqrt{\tau})dy} \Big|_{y=0} = \frac{8\pi\alpha^2}{9} \frac{1}{\sqrt{\tau}} \sum_q Q_q^2 \left[ f_q(\sqrt{\tau}) f_{\bar{q}}(\sqrt{\tau}) + f_{\bar{q}}(\sqrt{\tau}) f_q(\sqrt{\tau}) \right]$$

Scaling behavior: Compare to DIS

# PQCD: Drell – Yan - VIII

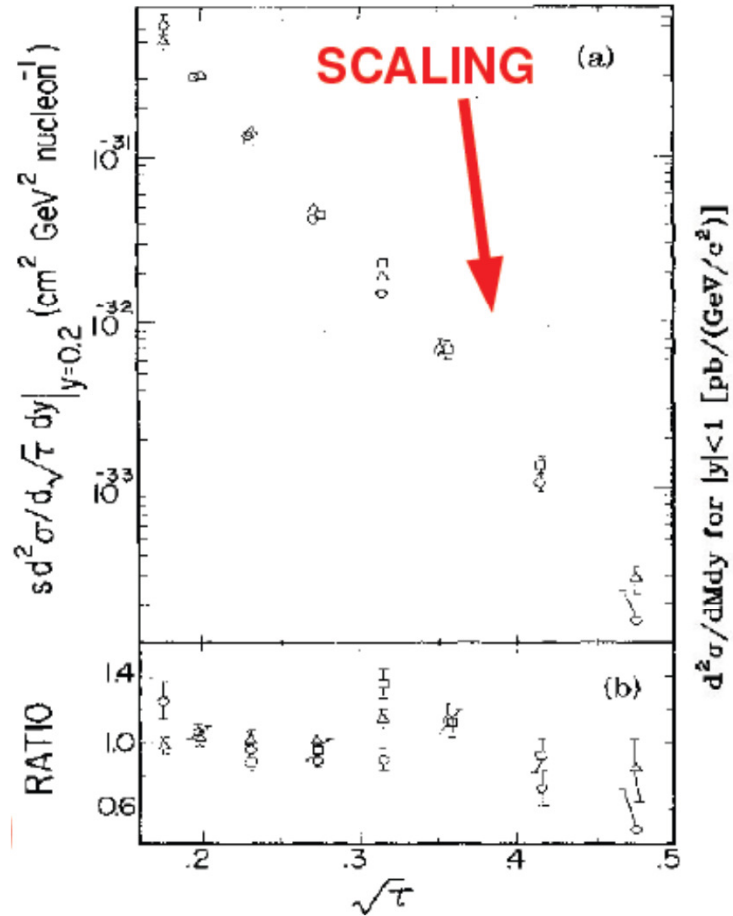

Drell-Yan differential cross-section

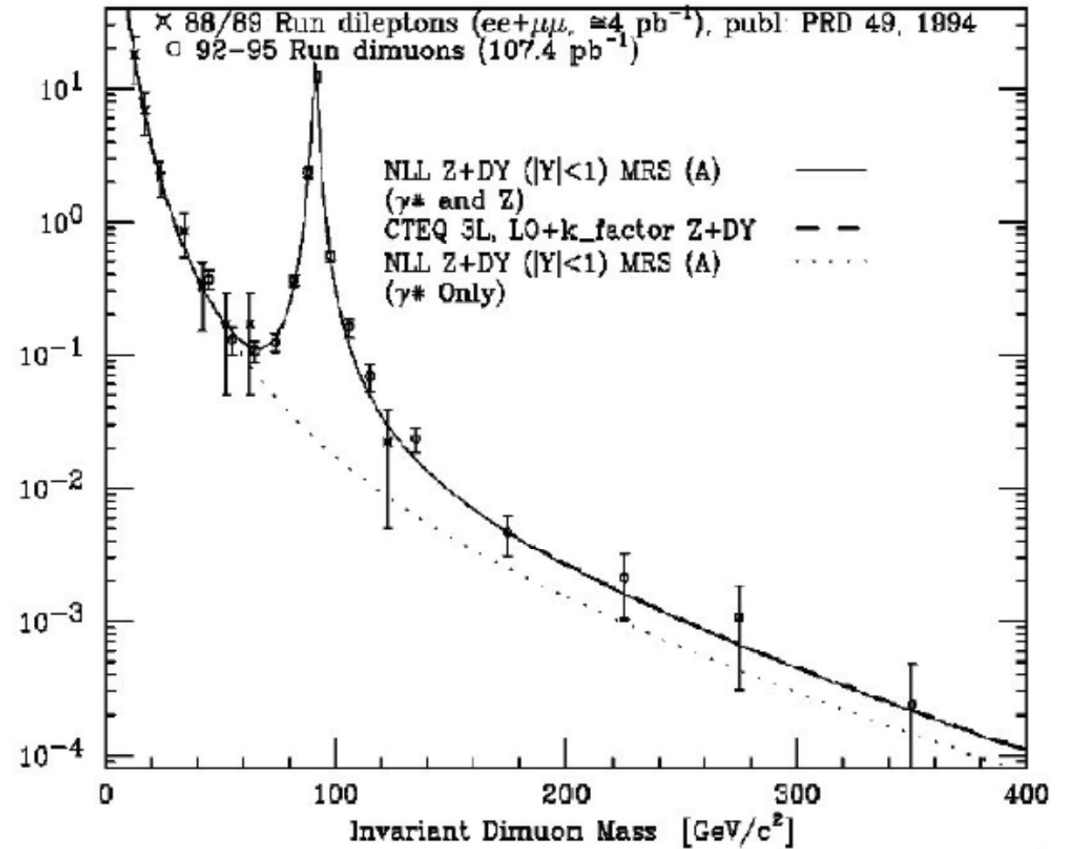

# PQCD: Drell – Yan - IX

135

NLO QCD corrections:

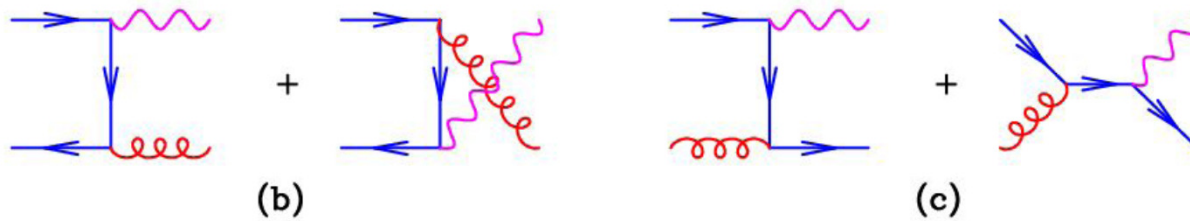
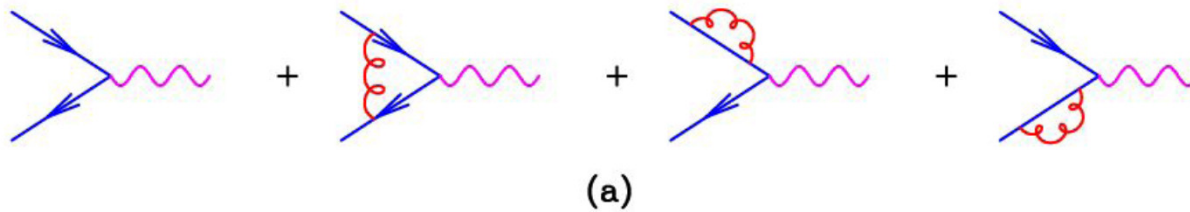

Quite similar to QCD corrections to:

$$e^+ e^- \rightarrow q \bar{q}$$

# PQCD: Drell – Yan - X

136

Total rate:

Same effect as for

$$e^+e^- \rightarrow q\bar{q}$$

Real gluons compensate virtual gluons

$$\sigma(\text{real}) + \sigma(\text{virtual}) = \frac{2\alpha_s}{3\pi} \sigma_0 \left( \frac{4\pi^2}{3} - \frac{7}{2} \right)$$

→ Overall effect lumped into a  $K$ -factor

$$K_{DY}^{(1)} = 1 + \frac{\alpha_s}{\pi} \left( \frac{8\pi^2}{9} - \frac{7}{3} \right) \approx 1 + 2.05\alpha_s \sim 2$$

→ QCD predicting a sizeable enhancement of total cross-section by a factor  $\sim 2$

# PQCD: Drell – Yan - XI

137

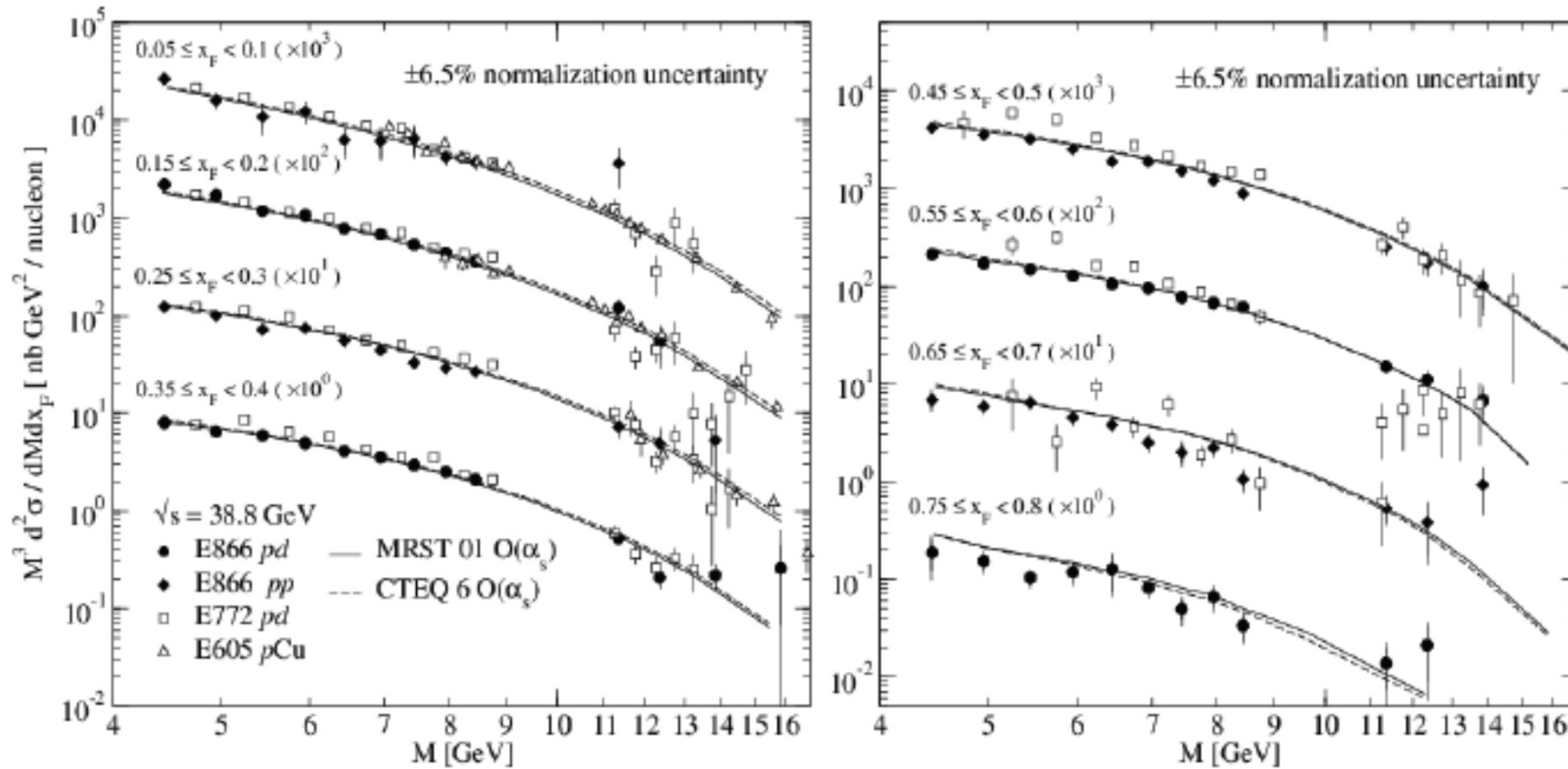

Extracting same PDFs as from DIS : Good check

Also extract PDFs for mesons

# PQCD: Drell – Yan - XII

138

Basic diagram generalized to include electroweak extensions:

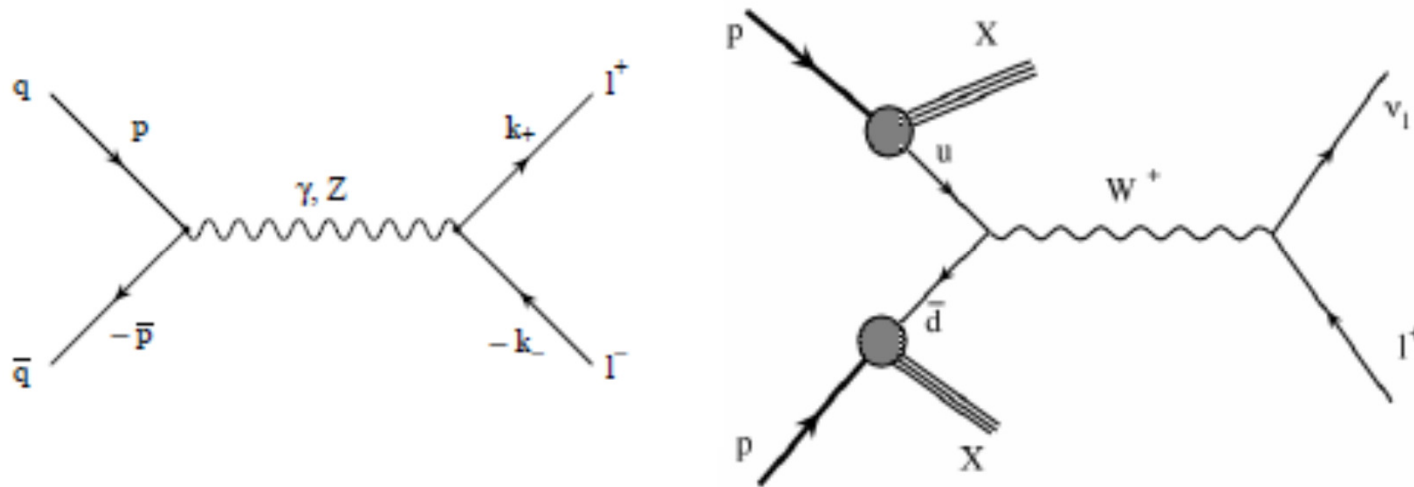

Quite important processes at hadron colliders

# PQCD: Drell – Yan - XIII

139

Drell-Yan at large: LHC

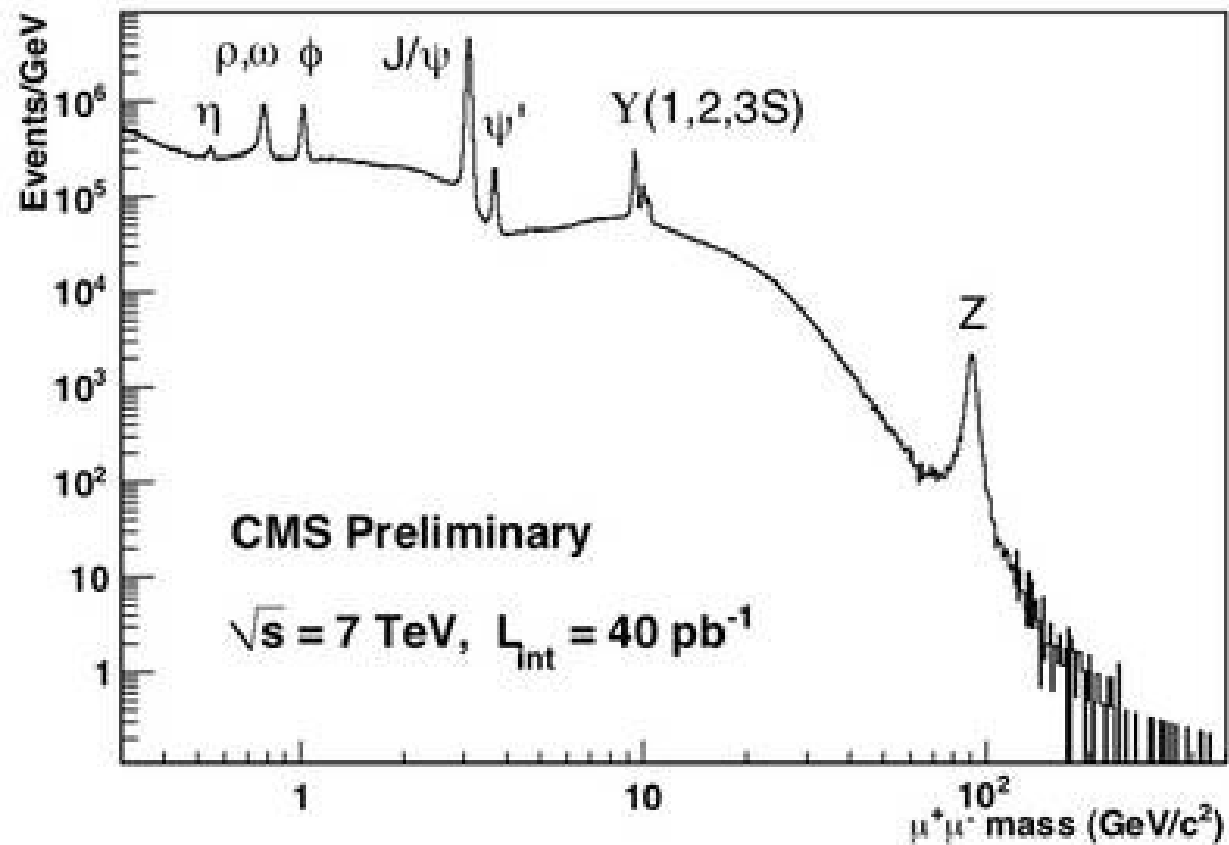

# PQCD: Hadron Collisions - I

Consider all the 2-body processes in QCD:

$$qq \rightarrow qq, q\bar{q} \rightarrow q\bar{q}$$

$$qg \rightarrow qg, \bar{q}g \rightarrow \bar{q}g, gg \rightarrow gg, q\bar{q} \rightarrow gg, gg \rightarrow q\bar{q}$$

Quarks only

Quarks and/or Gluons

All yielding 2 jets to LO



Figure 1: Feynman diagram for  $q_i q_j \rightarrow q_i q_j, i \neq j$

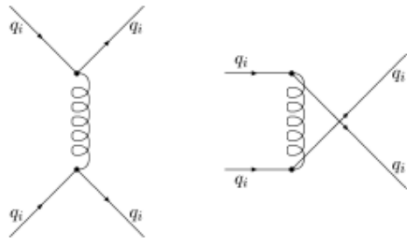

Figure 2: Feynman diagrams for  $q_i q_i \rightarrow q_i q_i$

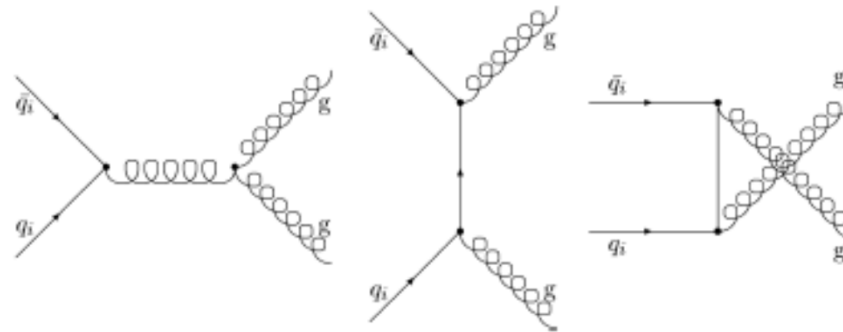

Figure 5: Feynman diagrams for  $q_i \bar{q}_i \rightarrow gg$



# PQCD: Hadron Collisions - II

141

When quark only processes can be identified, expect

$$\frac{d\sigma}{d(\cos\theta^*)} = \frac{\pi\alpha_s^2}{2s_{ij}} |M|^2$$

$$s_{ij} = (x_i p_i + x_j p_j)^2 \approx x_i x_j s$$

$$\rightarrow |M|^2 \propto 1 + \cos^2 \theta^* \text{ as usual}$$

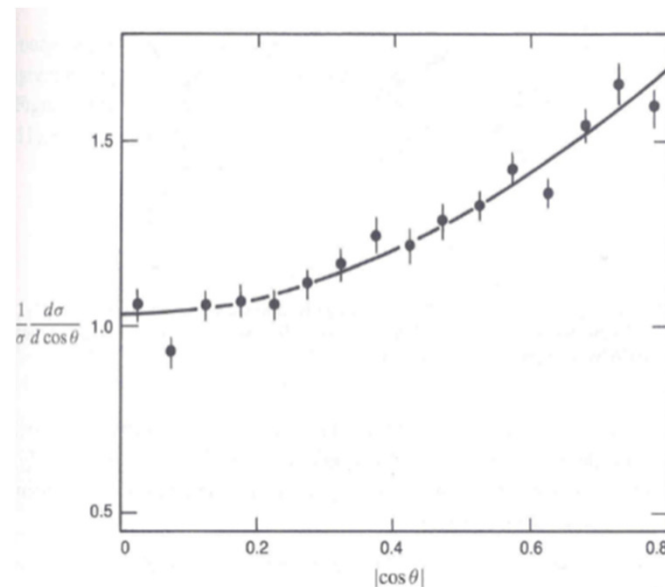

@TBA

# PQCD: Hadron Collisions - III

142

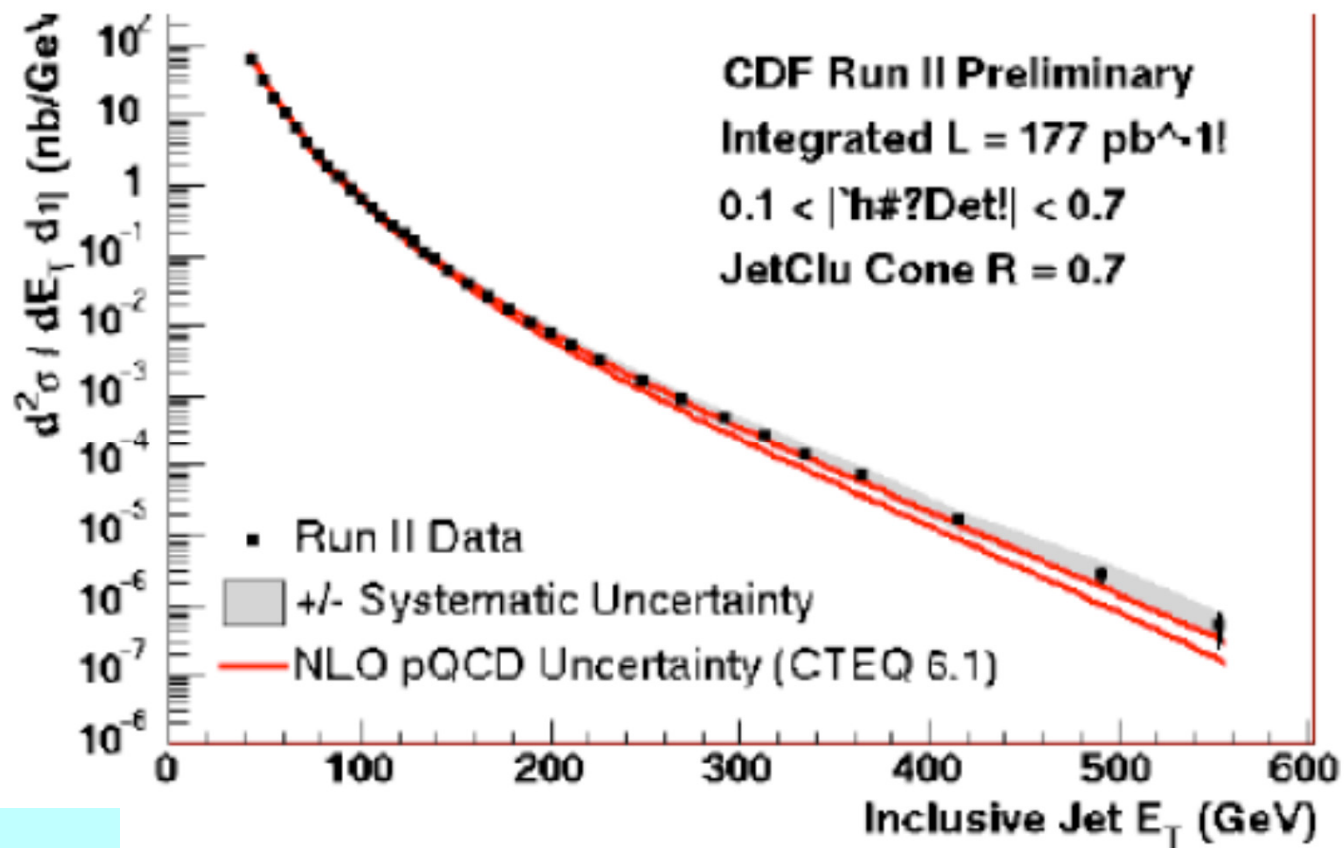

@TBA

# PQCD: Hadron Collisions - IV

143

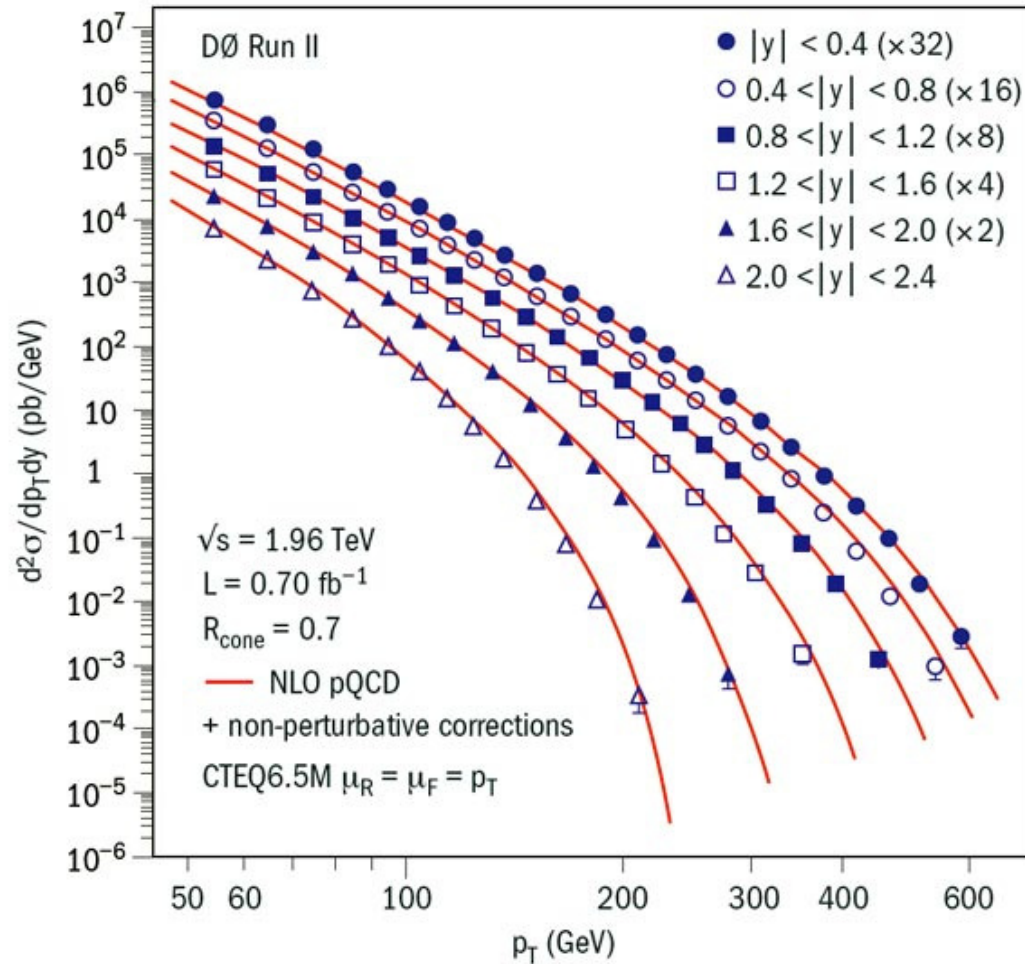

# PQCD: Hadron Collisions - V

144

Complete jet evolution cannot be computed in a full QCD framework:

As shown in the picture, *increasing* time scales correspond to *decreasing*  $Q^2$  scale, down to a region where perturbative expansion cannot be granted

Conversion of quarks and gluons into hadrons (*Fragmentation* or *Hadronization*) must be evaluated by ad-hoc prescriptions (models).

QCD-inspired, successful models often based on string-like behavior of  $q\bar{q}$  pairs

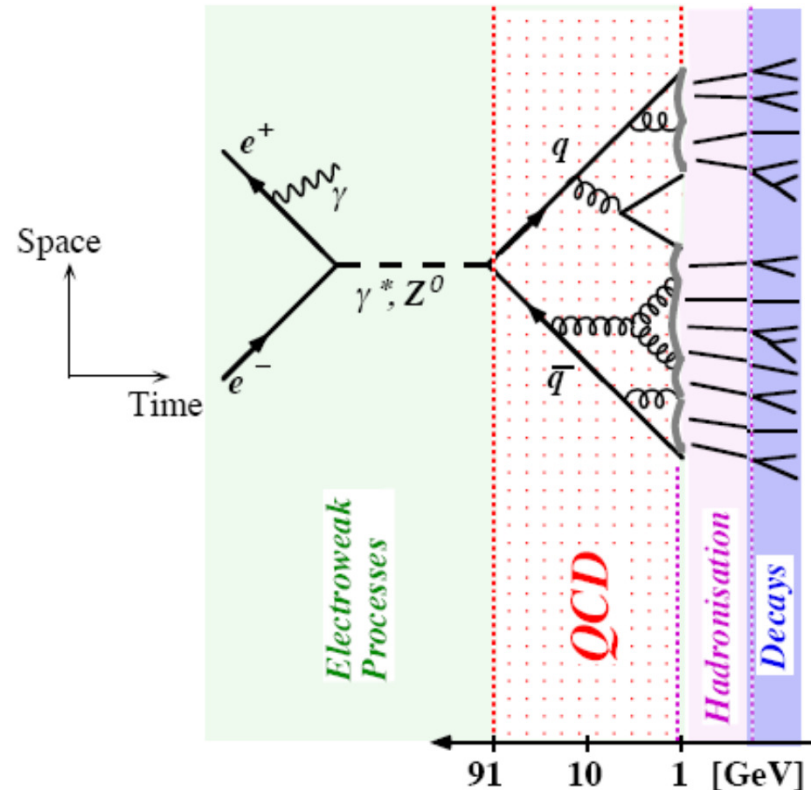

@TBA

# PQCD: Hadron Collisions - VI

145

Typical model implemented in fragmentation Montecarlo programs

$q\bar{q}$  Interaction

QED-like at small distance

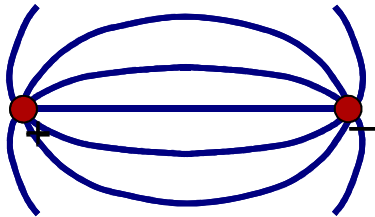

@TBA

Gluon self-interaction yields *string* (flux tube) pattern at large distance:  $F = const$



@TBA

Picture baryons as 'mesons':

$$3 \otimes 3 = 3^* \oplus 6$$

$$qqq = \underbrace{qq}_{\sim \bar{q}} + q$$

# Confinement - I

146

$$\alpha_s(|q^2|) \simeq \frac{12\pi}{21 \ln(|q^2|/\Lambda^2)}, \quad |q^2| \gg \Lambda^2$$

When  $|q^2| \sim \Lambda^2$ , the previous expression does not apply

$\alpha_s(\Lambda^2)$  is large

*Strong interaction is strong*

*Cannot rely on perturbative expansion*

In a general sense, expect  $\Lambda$  to mark the low energy range, corresponding to *soft* (low  $q^2$ ) processes

Bound states: Non-perturbative, 'white', energy scale  $\approx \Lambda$

Does  $\alpha_s(\Lambda^2)$  correspond to the *color confinement* range?

Very likely. But remember:

*It has not yet convincingly shown that QCD is a confining theory*

# Confinement - II

147

QCD: At large color charges separation, field lines compressed to tube-like regions

Reason: Gluon-gluon interaction

→  $\sim$  String



→  $F(r) \approx const \rightarrow V(r) = kr$  Linearly confining potential

$k \sim 1 \text{ GeV} / \text{fm}$

# Confinement - III

148

Regge trajectories: Old concept, adapted by potential scattering theory  
Very general property, not related to any constituent model:  
Linear relationship between angular momentum and  $(\text{mass})^2$  of resonances

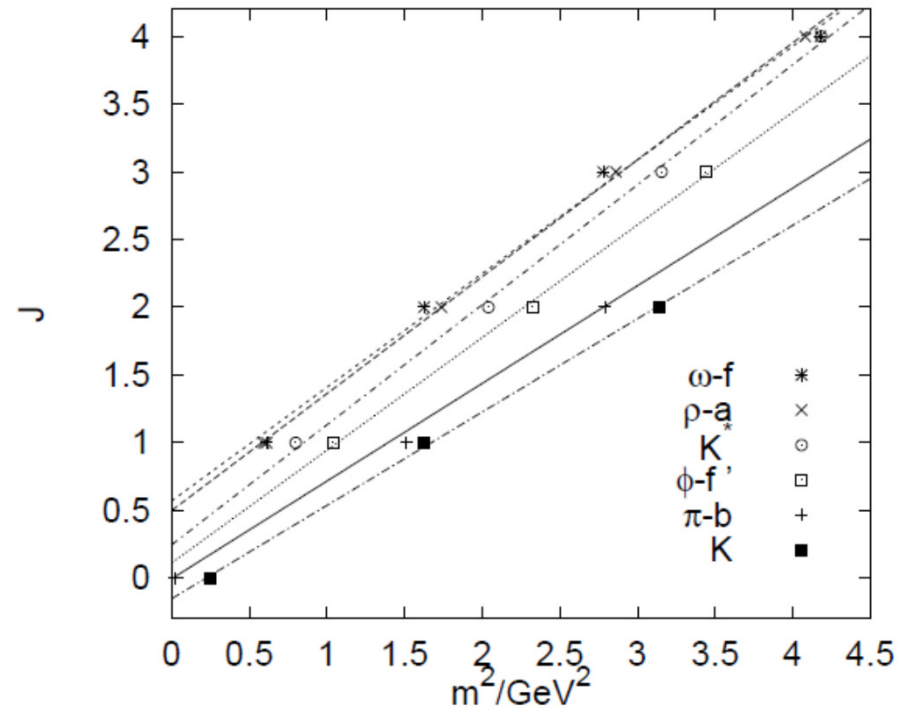



# Confinement - IV

149

String model of mesons: Simple 'explanation' of Regge trajectories

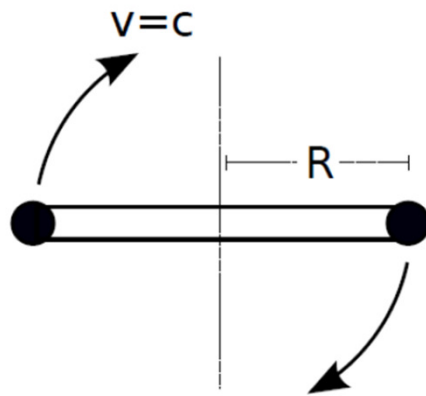

$$F^\mu = \frac{dP^\mu}{d\tau}, F^\mu = (\gamma \mathbf{F} \cdot \mathbf{u}, \gamma \mathbf{F}) \text{ relativistic 2nd law}$$

$$\rightarrow m = E = W = 2 \int_0^R \gamma \mathbf{F} \cdot d\mathbf{r}$$

$$\mathbf{F} = k \hat{\mathbf{r}} \leftrightarrow \text{linear potential}$$

$$\rightarrow m = E = 2 \int_0^R \gamma k \hat{\mathbf{r}} \cdot d\mathbf{r} = 2 \int_0^R \frac{k}{\sqrt{1-\beta^2}} dr$$

$$\beta = \frac{r}{R} \rightarrow m = E = 2k \int_0^R \frac{dr}{\sqrt{1-\left(\frac{r}{R}\right)^2}} = \pi k R$$

$$J = 2k \int_0^R \frac{\frac{r}{R}}{\sqrt{1-\left(\frac{r}{R}\right)^2}} dr = \frac{1}{2} \pi k R^2 = \frac{m^2}{2\pi k}$$

# Gluonia - I

150

QCD: Leading to predict new, 'exotic' (= non  $q\bar{q}$ ) mesonic states

Quarkless mesons: no valence quarks

→ *Gluonium*, aka *Glueball*

Expect, among others, exotic quantum numbers

Flavor: **1** Singlet (← no quark)

Color: Bound state → Must be **1** Singlet (← 'white')

→ 2  $g$  at least

$$\mathbf{8} \otimes \mathbf{8} = \mathbf{1} \oplus \mathbf{8} \oplus \mathbf{8} \oplus \mathbf{10} \oplus \overline{\mathbf{10}} \oplus \mathbf{27}$$

Pick singlet:

**1** ↔ Symmetric

Bose statistics → Spin × Orbital: Symmetric

Observe:

**1** of  $SU(3)_C$  exchange-symmetric

when originated by

$$\mathbf{8} \otimes \mathbf{8} = \mathbf{1} \oplus \mathbf{8} \oplus \mathbf{8} \oplus \mathbf{10} \oplus \mathbf{10}^* \oplus \mathbf{27}$$

# Gluonia - II

**J=L+S**

By taking *S* – wave (space symmetric):

$$L = 0 \rightarrow J = S = 1 \oplus 1 = 0, 1, 2$$

*S* = 0, 2 Symmetric  $\rightarrow$  OK

$$\left. \begin{aligned} P &= (-1)^L = +1 \\ C &= (-1)^2 = +1 \end{aligned} \right\} \rightarrow 0^{++}, 2^{++}$$

By taking *P* – wave (space antisymmetric):

$$L = 1 \rightarrow J = 1 \oplus 1 \oplus 1 = 0, 1, 2, 3$$

*S* = 1 Antisymmetric  $\rightarrow$  OK

$$\left. \begin{aligned} P &= (-1)^L = -1 \\ C &= (-1)^2 = +1 \end{aligned} \right\} \rightarrow 1^{-+}, \text{ Exotic!}$$

Compare to  $q\bar{q}$ , standard mesons:

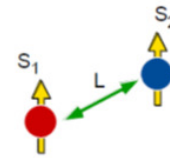

Allowed:  
 $J^{PC} = 0^{++}, 1^{-+}, 1^{+-}, 0^{+-}, 1^{+-}, 2^{+-}$

Not allowed: exotic combinations:  
 $J^{PC} = 0^{-+}, 0^{--}, 1^{-+}, 2^{+-}$

			2					
		+2	2	1				
+1	+1	1	+1	+1				
	+1	0	1/2	1/2	2	1	0	
	0	+1	1/2	-1/2	0	0	0	
			+1	-1	1/6	1/2	1/3	
			0	0	2/3	0	1/3	2
			-1	+1	1/6	1/2	1/3	-1
						0	-1	1/2
						-1	0	1/2
							-1	-1
								2
								-2
								1

# Gluonia - III

152

Indeed, build  $2g$  state out of single gluon states with defined helicity:

$$U_p |\mathbf{k}, R; -\mathbf{k}, R\rangle = |-\mathbf{k}, L; \mathbf{k}, L\rangle \quad \text{not a } U_p \text{ eigenstate}$$

$$U_p |\mathbf{k}, L; -\mathbf{k}, L\rangle = |-\mathbf{k}, R; \mathbf{k}, R\rangle \quad \text{not a } U_p \text{ eigenstate}$$

$$U_p |\mathbf{k}, R; -\mathbf{k}, L\rangle = |-\mathbf{k}, L; \mathbf{k}, R\rangle \equiv |\mathbf{k}, R; -\mathbf{k}, L\rangle$$

$$\rightarrow U_p \text{ eigenstate, } \eta_p = +1, J_3 = +2 \rightarrow J = 2$$

$$U_p |\mathbf{k}, L; -\mathbf{k}, R\rangle = |-\mathbf{k}, R; \mathbf{k}, L\rangle \equiv |\mathbf{k}, L; -\mathbf{k}, R\rangle$$

$$\rightarrow U_p \text{ eigenstate, } \eta_p = +1, J_3 = -2 \rightarrow J = 2$$

$$|\mathbf{k}, R; -\mathbf{k}, R\rangle \pm |\mathbf{k}, L; -\mathbf{k}, L\rangle$$

$$\rightarrow U_p \text{ eigenstates, } \eta_p = \pm 1, J_3 = 0 \rightarrow J = 0, 2$$

$$\rightarrow \text{Pick } |\mathbf{k}, R; -\mathbf{k}, R\rangle + |\mathbf{k}, L; -\mathbf{k}, L\rangle \text{ (symmetric)} \rightarrow \eta_p = +1$$

# Quarkonium - I

153

Small distance: Perturbative!

Indeed: Large quark mass  $\rightarrow$  Large  $Q^2$

$\rightarrow$  One gluon exchange OK

Non relativistic effective potential  $\sim$  Coulomb-like

$$\rightarrow V\left(r \ll \frac{1}{m_q}\right) \approx -\frac{4}{3} \frac{\alpha_s}{r}$$

Add phenomenological confining term: String inspired

$\rightarrow$  Full potential:

$$V(r) \approx -\frac{4}{3} \frac{\alpha_s}{r} + kr$$

Most interesting  $q\bar{q}$  physics case: Heavy, neutral, flavorless mesons

In order to better understand it, revert for a while to simple QED bound state: *Positronium*

# Quarkonium - II

154

Bound state of electron - positron: Similar to Hydrogen atom

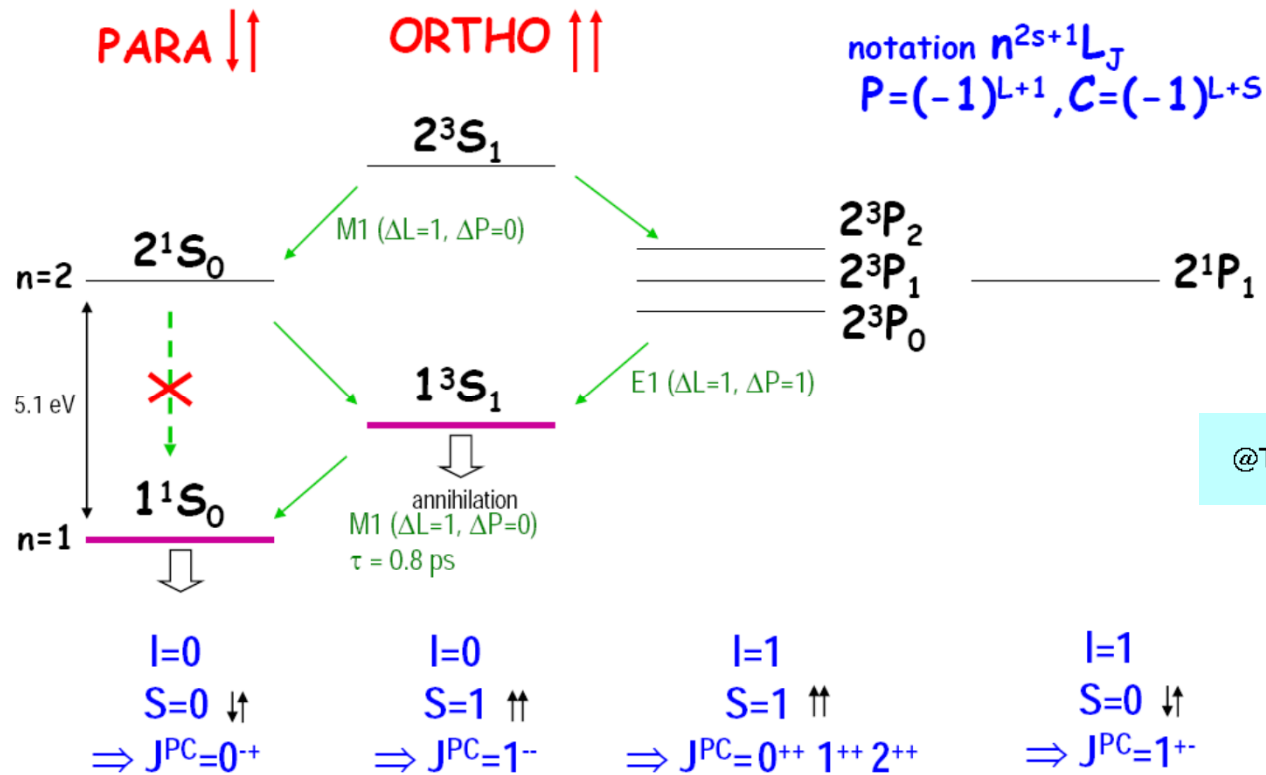

# Quarkonium - III

Family portrait of *-onia*:

@TBA

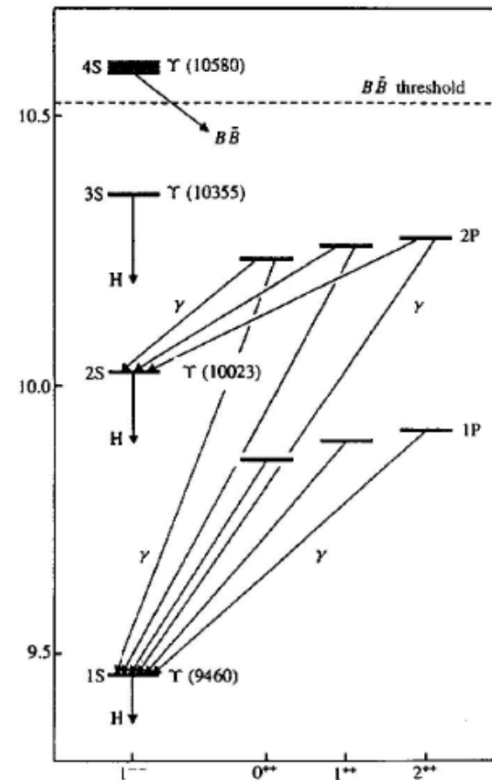
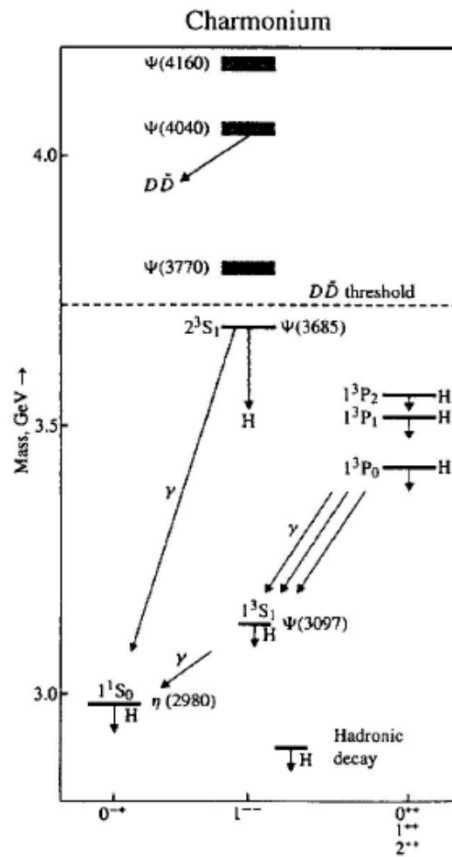
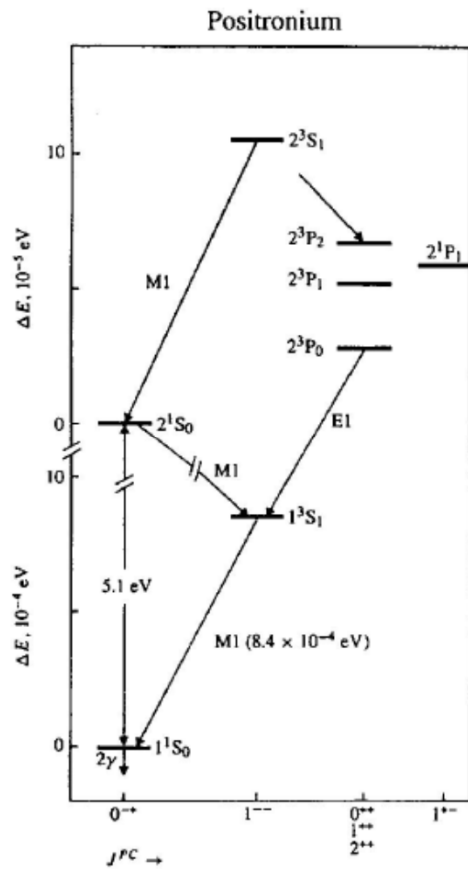

# Quarkonium - IV

156

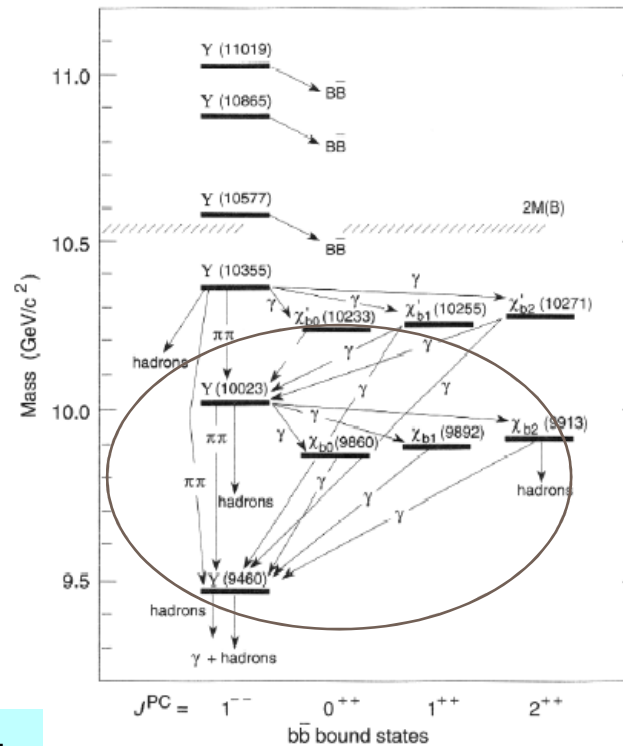
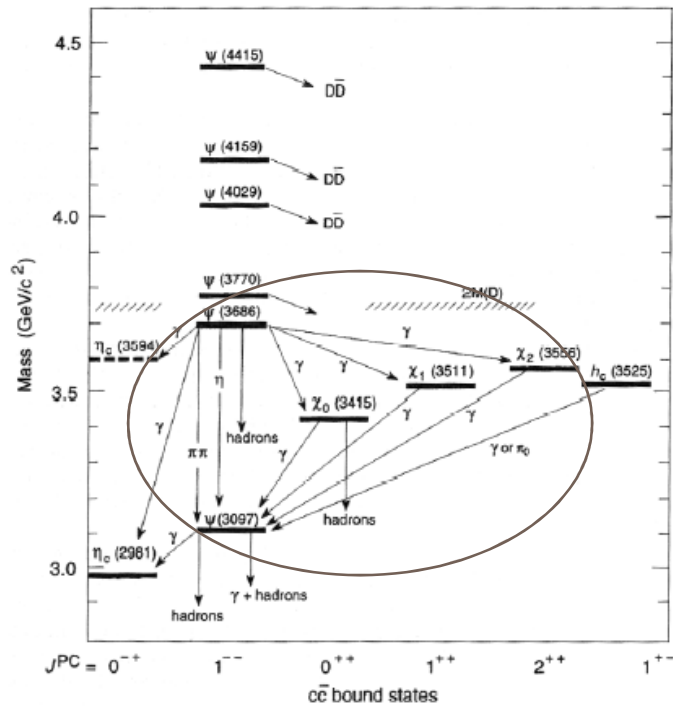

@TBA

Striking similarity,  $\approx$  same energy scale *above ground state*



# Quarkonium - V

157

Original interest for non-relativistic, Schrodinger equation approach:

$\Delta E(\text{charm}) \simeq \Delta E(\text{bottom})$       Amazingly close

E288	$M(\Upsilon') - M(\Upsilon)$	$M(\Upsilon'') - M(\Upsilon)$
Two-level fit	$650 \pm 30 \text{ MeV}$	
Three-level fit	$610 \pm 40 \text{ MeV}$	$1000 \pm 120 \text{ MeV}$
$M(\psi') - M(\psi)$	$\approx 590 \text{ MeV}$	

Yesterday 1977

Today 2012

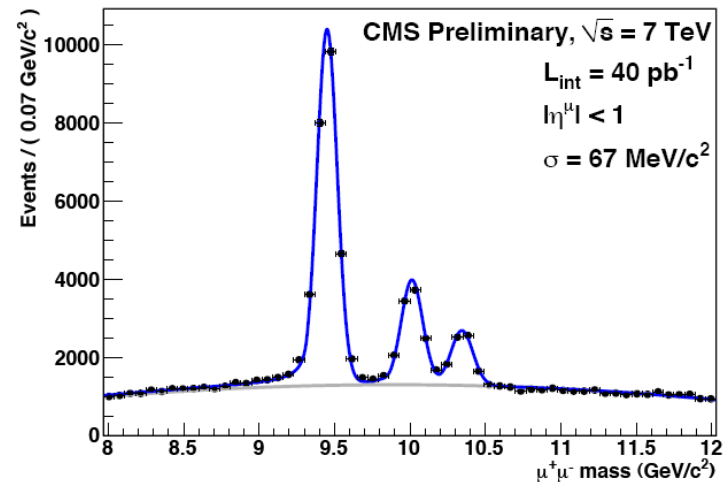
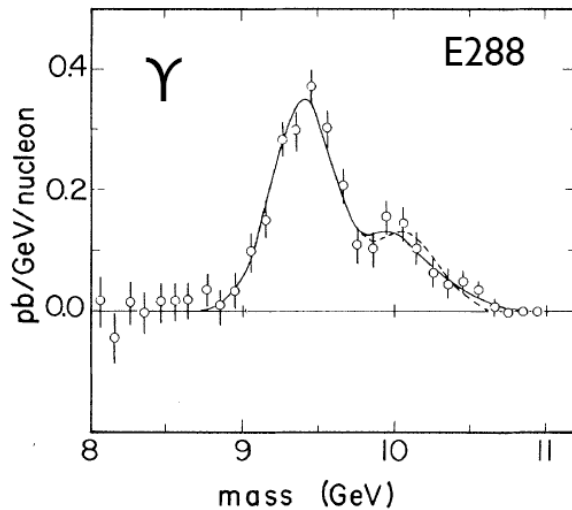

# Quarkonium - VI

158

Reminder: Bohr radius

$$R = \frac{n^2}{\alpha m} \rightarrow R_0 = \frac{1}{\alpha m}$$

Consequence of Coulomb potential, static limit of 1 photon diagram

If 1 gluon exchange approximation can be granted, expect for quarkonium

$$R_{q\bar{q}} \sim \frac{1}{\alpha_s m}$$

Observe:  $m$  large  $\rightarrow R$  small  $\rightarrow \alpha_s$  small  $\rightarrow$  1 gluon appr. OK: Self-consistent

Use phenomenological,  $q\bar{q}$  confining term like this:

$$V(r) = -\frac{4}{3} \frac{\alpha_s}{r} + kr$$

Solve Schrodinger equation with these terms

(Add more terms to take into account relativistic & color-hyperfine effects)

Question: Which form of effective potential would yield  $m$ -independent  $\Delta E$  ??

# Quarkonium - VII

159

Scaling Schroedinger:

$$\psi(r) = R(r)Y_{lm}(\theta, \varphi), \quad u(r) = rR(r)$$

$$\mu = \frac{m}{2} \quad \text{Reduced mass}$$

$$V(r) = \lambda r^\nu \quad \text{Power law potential}$$

$$\frac{\hbar^2}{2\mu} \frac{d^2 u}{dr^2} + \left[ E - \lambda r^\nu - \frac{l(l+1)}{2\mu r^2} \right] u(r) = 0 \quad \text{Radial Schrodinger equation}$$

$$r = \rho \left( \frac{\hbar}{2\mu|a|} \right)^{\frac{1}{2+\nu}} \quad \text{Scale radial distance}$$

$$E = \varepsilon \left( \frac{\hbar}{2\mu|\lambda|} \right)^{-\frac{2}{2+\nu}} \frac{\hbar^2}{2\mu} \quad \text{Scale energy}$$

$$w(\rho) = u(r)$$

$$\rightarrow \frac{d^2 w}{d\rho^2} + \left[ \varepsilon - \rho^\nu - \frac{l(l+1)}{\rho^2} \right] w(\rho) = 0 \quad \text{Adimensional radial equation}$$

3 parameters:

$\mu$  reduced mass  $\equiv \frac{m_q}{2}$  for  $q\bar{q}$

$\lambda$  strength

$\nu$  exponent

# Quarkonium - VIII

160

## Scaling laws

Length:	$L \propto (\mu \lambda )^{-\frac{1}{\nu+2}}$	Energy: $E \propto (\mu)^{-\frac{\nu}{\nu+2}}  \lambda ^{\frac{2}{\nu+2}}$
Coulomb	$(\mu \lambda )^{-1}$	$\mu \lambda ^2$
Logarithmic	$(\mu \lambda )^{-\frac{1}{2}}$	$\mu^0  \lambda $
Linear	$(\mu \lambda )^{-\frac{1}{3}}$	$\mu^{-\frac{1}{3}}  \lambda ^{\frac{2}{3}}$
Harmonic	$(\mu \lambda )^{-\frac{1}{4}}$	$\mu^{-\frac{1}{2}}  \lambda ^{\frac{1}{2}}$
Well	$(\mu \lambda )^0$	$\mu^{-1}$

# Quarkonium - IX

161

## Cornell potential

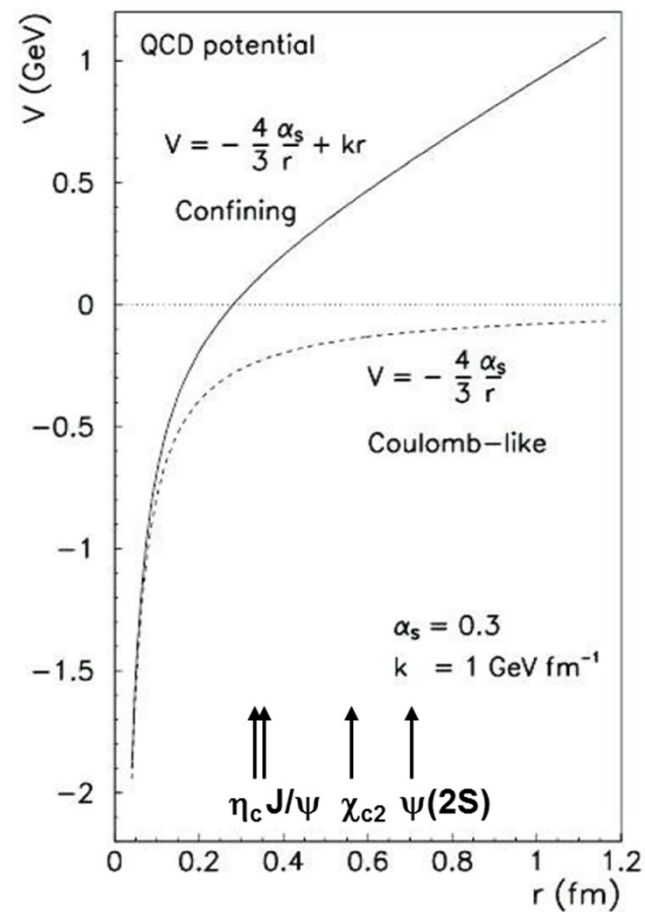

# Quarkonium - X

162

Several interesting applications:

1) Logarithmic potential yielding  $\Delta E$  mass independent

Also obtained by properly fitted Cornell potential

$$\rightarrow \text{Fit} \begin{cases} \alpha_s \left( q^2 = (2m_q)^2 \right) \sim 0.25 - 0.35 \\ k \sim 1 \text{ GeV} / \text{fm} \end{cases}$$

2) Extra bonus:

$$\text{Probability density} \propto L^{-3} \rightarrow |\psi(0)|^2 \sim (\mu|\lambda|)$$

$\rightarrow$  Fix partial width to  $e^+e^-$  of vector mesons

# Van-Royen - Weisskopf - I

163

Attempting to calculate the vector meson decay rate:

$\Gamma_V = |A_V|^2$ ,  $A_V = \langle f | T | V \rangle$  Transition amplitude between  $V$  (initial),  $f$  (final) state

The meson is a bound state  $\rightarrow$  Initial state *not* a plane wave!

Then expand the amplitude into plane waves:

$$A_V = \sum_p \underbrace{\langle f | T | p \rangle}_{A(\mathbf{p})} \underbrace{\langle p | V \rangle}_{\psi(\mathbf{p})}$$

$A(\mathbf{p})$  plane wave amplitude,  $\psi(\mathbf{p})$  momentum space wave function

$$\rightarrow A_V = \int d^3\mathbf{p} A(\mathbf{p}) \psi(\mathbf{p}) = \frac{1}{(2\pi)^{3/2}} \int d^3\mathbf{p} A(\mathbf{p}) \int \psi(\mathbf{r}) e^{i\mathbf{p}\cdot\mathbf{r}} d^3\mathbf{r} = \frac{1}{(2\pi)^{3/2}} \int d^3\mathbf{r} \psi(\mathbf{r}) \int A(\mathbf{p}) e^{i\mathbf{p}\cdot\mathbf{r}} d^3\mathbf{p}$$

$$\text{Take } A(\mathbf{p}) \approx A = \text{const} \rightarrow A_V \approx \frac{A}{(2\pi)^{3/2}} \int d^3\mathbf{r} \psi(\mathbf{r}) \underbrace{\int e^{i\mathbf{p}\cdot\mathbf{r}} d^3\mathbf{p}}_{(2\pi)^3 \delta^3(\mathbf{r})} = (2\pi)^{3/2} A \psi(0)$$

$$\rightarrow \Gamma_V = |A_V|^2 \approx (2\pi)^3 |A|^2 |\psi(0)|^2$$

Why is  $A(p) \approx \text{const}$ ?

# Van-Royen - Weisskopf - II

164

Consider the process involving free quarks (plane wave):

$$q\bar{q} \rightarrow e^+e^-$$

Cross section, averaged over initial, summed over final spin projections:

$$\sigma_{q\bar{q} \rightarrow e^+e^-}(p) = \underbrace{|A(p)|^2}_{\text{flux}} \frac{1}{v}, \quad v, q, \bar{q} \text{ relative velocity} \rightarrow \sigma_{q\bar{q} \rightarrow e^+e^-}(p) = |A(p)|^2 \frac{(2\pi)^3}{v}$$

Take 1-photon annihilation QED diagram:

$$\sigma_{q\bar{q} \rightarrow e^+e^-}(p) = \frac{\pi\alpha^2 Q^2}{s} \frac{p_e}{p_q} \left( 1 + \frac{v^2}{3} + \frac{4m_q^2}{s} \right) \quad \begin{array}{l} \text{Just the same as } e^+ + e^- \rightarrow \mu^+ + \mu^- \\ \text{But: Do not neglect rest mass} \end{array}$$

For small initial velocity:

$$s \approx (2m_q)^2, \quad p_q \approx m_q \frac{v}{2}$$

$$\sigma_{q\bar{q} \rightarrow e^+e^-}(p) = \frac{\pi\alpha^2 Q^2}{s} \frac{p_e}{p_q} \left( 1 + \frac{v^2}{3} + \frac{4m_q^2}{s} \right) \approx \frac{\pi\alpha^2 Q^2}{4m_q^2} \frac{p_e}{m_q \frac{v}{2}} \left( 1 + \frac{v^2}{3} + 1 \right) \approx \frac{\pi\alpha^2 Q^2}{4m_q^2} \frac{p_e}{m_q v} 4 \approx \frac{\pi\alpha^2 Q^2}{m_q^3} \frac{p_e}{v}$$



# Van-Royen - Weisskopf - III

165

Obtain the decay rate:

$$\rightarrow \sigma_{q\bar{q} \rightarrow e^+e^-}(p) = |A(p)|^2 \frac{(2\pi)^3}{v} = \frac{\pi\alpha^2 Q^2}{m_q^3} \frac{p_e}{v}$$

$$\rightarrow |A(p)|^2 = \frac{\pi\alpha^2 Q^2}{m_q^3} \frac{p_e}{v} \frac{v}{(2\pi)^3} = \frac{\pi\alpha^2 Q^2}{m_q^3} \frac{p_e}{(2\pi)^3}$$

$$p_e \approx m_q \rightarrow |A(p)|^2 \approx \frac{\pi\alpha^2 Q^2}{(2\pi)^3 m_q^2} \quad \text{Neglect quark momentum, electron mass}$$

$$m_q \approx \frac{M_V}{2} \rightarrow |A(p)|^2 \approx \frac{4\pi\alpha^2 Q^2}{(2\pi)^3 M_V^2} \quad p\text{-independent OK}$$

We took the average over initial spins for our plane wave cross section, resulting in 3 (triplet) + 1 (singlet) = 4 states

Vector mesons have spin 1, so we should not count spin 0

→Get another factor 4/3:

$$\Gamma_V \approx (2\pi)^3 |A|^2 |\psi(0)|^2 \approx (2\pi)^3 \frac{4}{3} \frac{4\pi\alpha^2 Q^2}{(2\pi)^3 M_V^2} |\psi(0)|^2 = \frac{16}{3} \frac{\pi\alpha^2 Q^2}{M_V^2} |\psi(0)|^2$$

Van Royen - Weisskopf formula from the roaring '60s

Still incomplete, but useful

# Van-Royen - Weisskopf - IV

166

For Bottomonium and Charmonium:

$$|\psi_q(0)|^2 \sim (\mu|\lambda|)^3 = \left(\frac{m_q}{2}|\lambda|\right)^3 = \frac{m_q^3}{8}|\lambda|^3$$

$$\rightarrow \Gamma_q \approx \frac{4}{3}(2\pi)^3 \frac{4\pi\alpha^2 Q_q^2}{(2\pi)^3 M_V^2} |\psi(0)|^2 \sim \frac{4}{3} \frac{\pi\alpha^2 Q_q^2}{m_q^2} \frac{m_q^3}{8} |\lambda|^3 = \frac{\pi\alpha^2 Q_q^2 m_q}{6} |\lambda|^3$$

$$\rightarrow \frac{\Gamma_\Upsilon}{\Gamma_\psi} \approx \frac{Q_b^2 m_b}{Q_c^2 m_c} \approx \frac{Q_b^2 9.46}{Q_c^2 3.10}$$

$$\Gamma_\psi(ee) \simeq 5.55 \text{ KeV}$$

DORIS (DESY) results (1978):

$$\Gamma_\Upsilon(ee) \simeq 1.26 \text{ KeV}$$

$$\rightarrow \left|\frac{Q_b}{Q_c}\right| \approx \sqrt{\frac{\Gamma_\Upsilon m_c}{\Gamma_\psi m_b}} \approx \sqrt{\frac{1.26 \cdot 3.10}{5.55 \cdot 9.46}} \sim 0.28 \rightarrow |Q_b| = \frac{1}{3} \text{ strongly preferred}$$

# OZI Rule - I

167

Okubo-Zweig-Iizuka Rule: *Disconnected diagrams are suppressed*

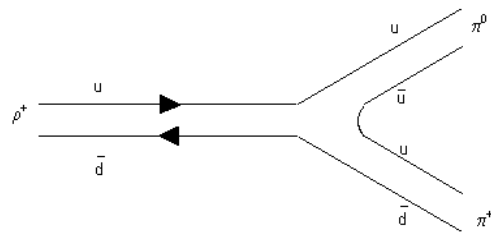

This diagram is connected

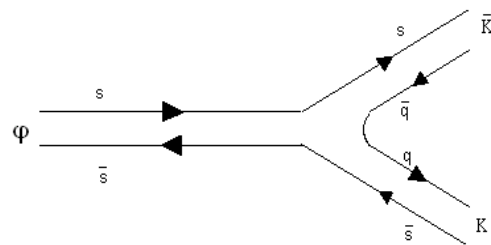

This diagram is connected: *BR 83 %*  
(with smallish phase space)

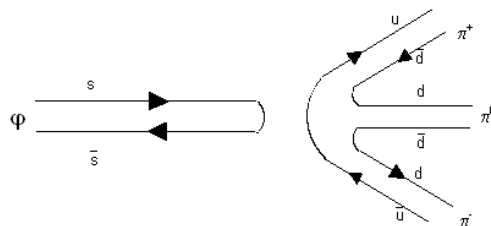

This diagram is disconnected: *BR 15 %*  
(with much larger phase space)

# OZI Rule - II

168

Compare mass and width

$$m_{J/\psi} = 3097 \text{ MeV}, \Gamma_{J/\psi} = 80 \text{ keV} \quad J^{PC} = 1^{-}$$

$$m_{\psi'} = 3686 \text{ MeV}, \Gamma_{\psi'} = 250 \text{ keV} \quad J^{PC} = 1^{-}$$

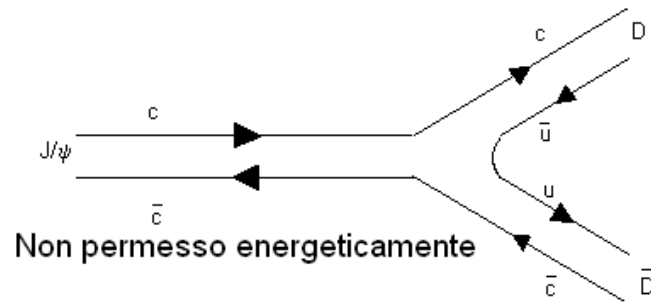

Explaining the small width:

$$m_{D^0} = 1865 \text{ MeV} \rightarrow 2 \times m_{D^0} = 3730 \text{ MeV} > m_{J/\psi}, m_{\psi'}$$

Therefore  $J/\psi, \psi'$  decay to open charm is energetically forbidden

→ Decay diagrams are disconnected

→ OZI rule: Decay is suppressed

→ *States are very narrow*

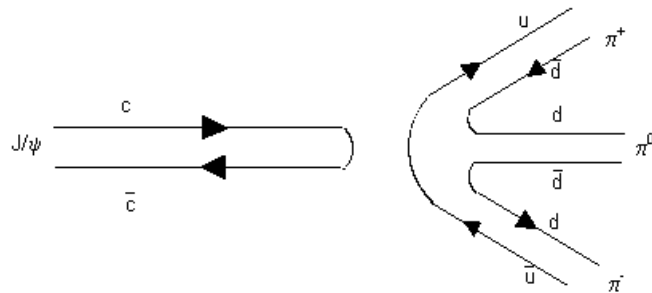

# OZI Rule - III

169

As a general rule

$\rightarrow A \propto \alpha_s^n$   $n =$  number of gluons

Hard gluon  $\rightarrow \alpha_s$  small

Soft gluon  $\rightarrow \alpha_s$  large

*Connected diagrams: Large number of soft gluons  $\rightarrow A =$  large*

*Disconnected diagrams: Small number of hard gluons  $\rightarrow A =$  small*

Indeed:

Single gluon annihilation is forbidden for mesons by color conservation (meson =  $\mathbf{1}$ , gluon =  $\mathbf{8}$ )

Annihilation of massive quarks yields hard gluons  $\rightarrow \alpha_s$  is small

Connected diagrams involve softer gluons  $\rightarrow \alpha_s$  is large

# OZI Rule - IV

170

Consider quarkonium annihilation into gluons:

$$q\bar{q} \rightarrow g \quad \text{Excluded: } (q\bar{q})_1 \not\rightarrow (1g)_8$$

$$q\bar{q} \rightarrow gg \quad \text{Allowed}$$

$$q\bar{q} \rightarrow ggg \quad \text{Allowed}$$

Decompose the direct product of 2 octets:

$$8 \otimes 8 = 1 \oplus 8 \oplus 8 \oplus 10 \oplus 10^* \oplus 27$$

Charge Parity:

$$J^{PC} = 0^{-+} \rightarrow C = +1 \rightarrow 2g \text{ OK}$$

$$J^{PC} = 1^{--} \rightarrow C = -1 \rightarrow 3g \text{ OK}$$

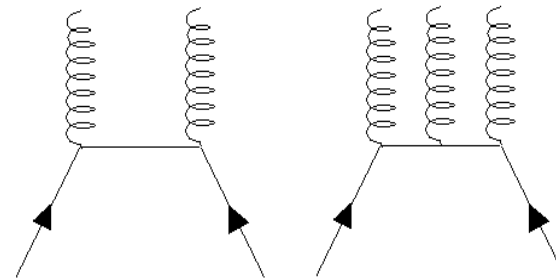

Perturbative regime:  $A(2g) > A(3g)$

→Pseudoscalars wider than vectors

# OZI Rule - V

171

By comparison with positronium:

$$(e^+e^-)_{\text{positronium}} \rightarrow \gamma\gamma$$

$$\Gamma[(e^+e^-) \rightarrow \gamma\gamma] = \frac{\alpha^2}{m^2} |\psi(0)|^2$$

$$(c\bar{c})_{\text{charmonium}} \rightarrow \gamma\gamma$$

$$\left\{ \begin{array}{l} e \rightarrow \frac{2}{3}e \rightarrow \alpha \rightarrow \frac{4}{9}\alpha \text{ Quark charge} \\ \times 9 \text{ Sum amplitude over colors} \end{array} \right.$$

$$\Gamma[(c\bar{c}) \rightarrow \gamma\gamma] = \frac{48\alpha^2}{27m_c^2} |\psi_{c\bar{c}}(0)|^2$$

$$(c\bar{c})_{\text{charmonium}} \rightarrow gg$$

From SU(3) algebra: 2  $g$  in a color singlet state

$$\text{Color factor} = \frac{9}{8}$$

$$\Gamma[(c\bar{c}) \rightarrow gg] = \frac{2\alpha_s^2}{3m_c^2} |\psi_{c\bar{c}}(0)|^2$$

But:

Positronium rate was obtained by taking the low speed limit of scattering amplitude to 1-photon approx

Is it granted for  $c\bar{c}$  ?

# Crystal Ball - I

172

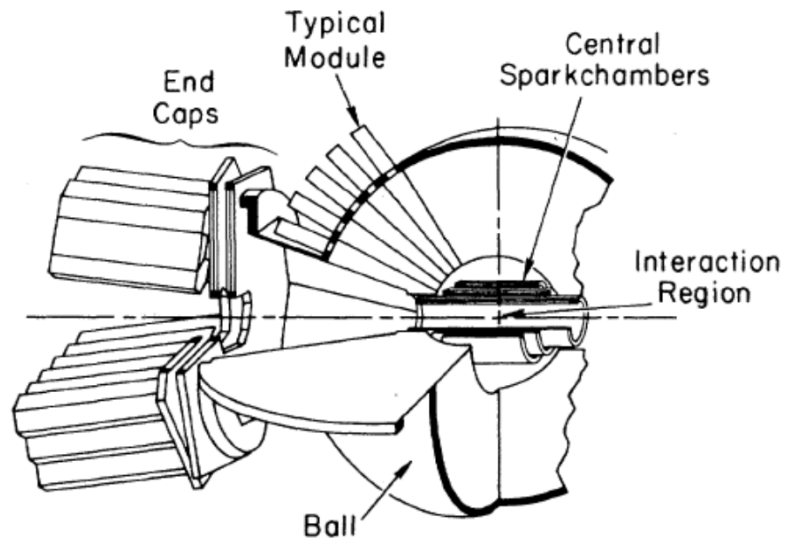

94% of solid angle covered

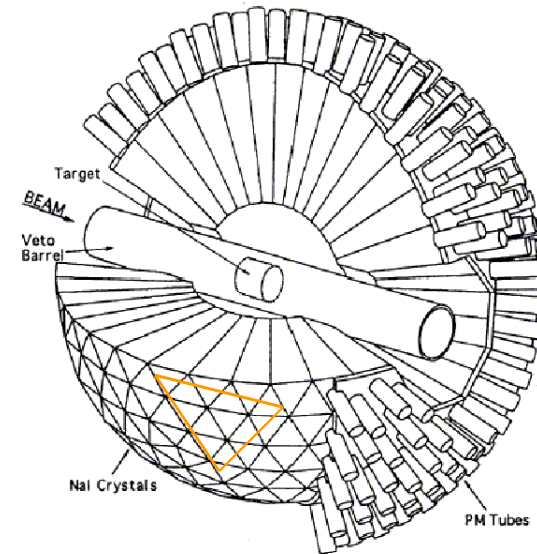

@TBA

Sodium Iodide

$NaI(Tl)$ : Inorganic scintillating crystal;  $Tl$  is an activator

Merits:

Can grow large crystals

Lots of light



# Crystal Ball - II

173

672 optically isolated NaI(Tl) crystals, 15.7 radiation lengths thick  
Inner radius 25.3 cm; Outer radius 66.0 cm

CB geometry: Based on *icosahedron*.

Each of the 20 triangular faces (major triangles) is divided into four minor triangles, each consisting of nine separated crystals.

Each crystal: Truncated triangular pyramid, 40.6 cm high, pointing towards the center of the Ball.

Side on the inner end: 5.1 cm ; Side on the outer end: 12.7 cm

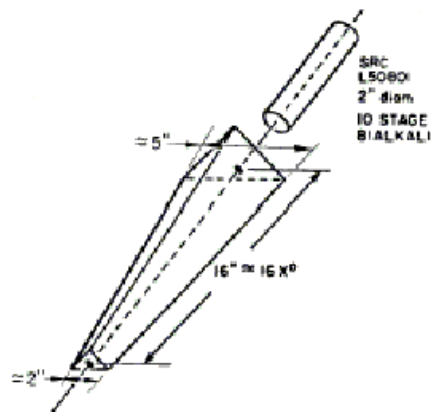

Crystal & Photomultiplier

# Crystal Ball - III

174

Icosahedron magic: Platonic solid (!) , 20 equilateral triangle faces

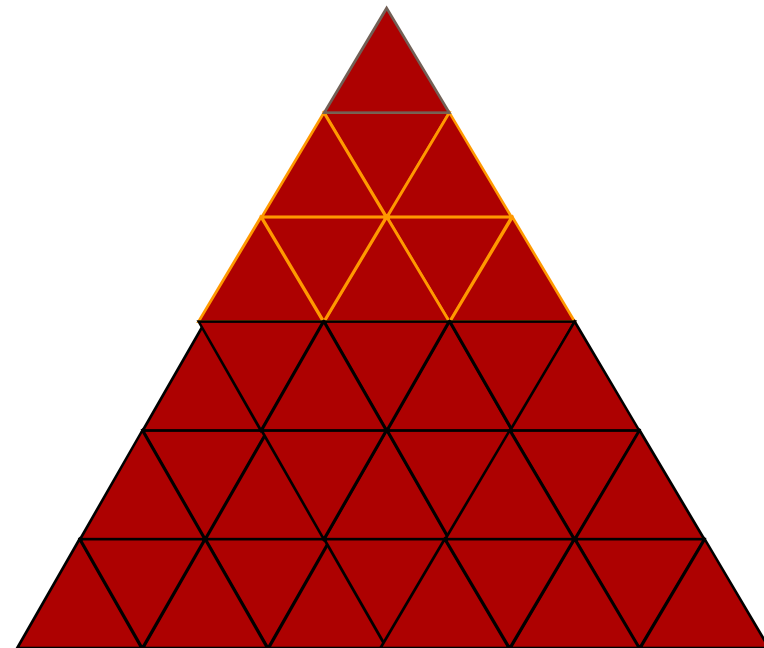
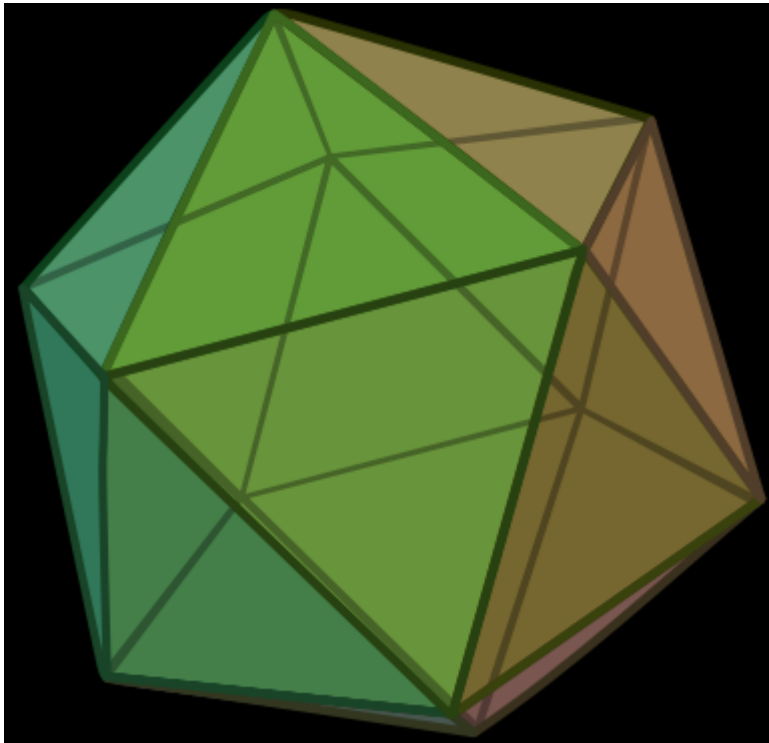

@TBA

Triangle count:

Large triangle 20

Small triangle 80

Crystal < 720 (edges)

# Crystal Ball - IV

175

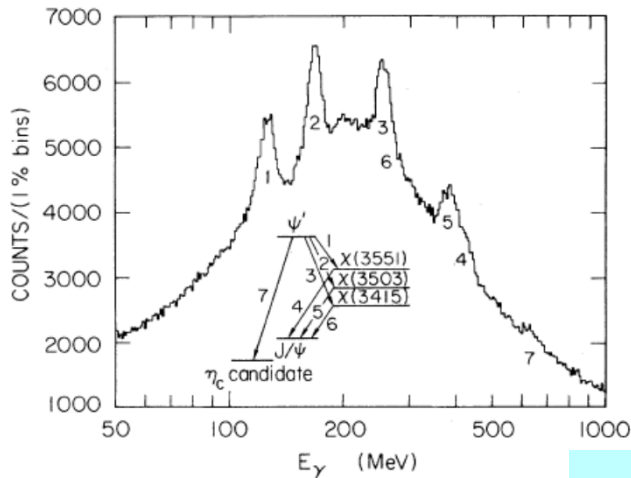

Inclusive photon spectrum

@TBA

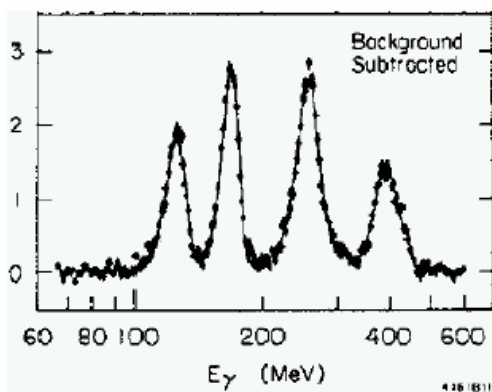

Most important results, among many:  
*Tune beam energy as to form  $\psi'$ (3686)*  
*Observe decays into photon + X*

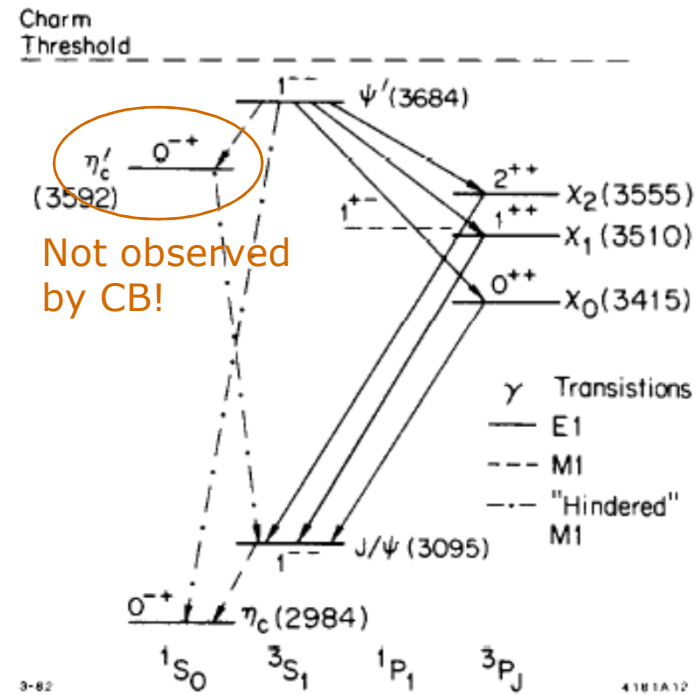

# Crystal Ball - V

176

After moving the CB detector to DORIS (DESY, Hamburg): Bottomonium!  
Observation of the P-wave triplets

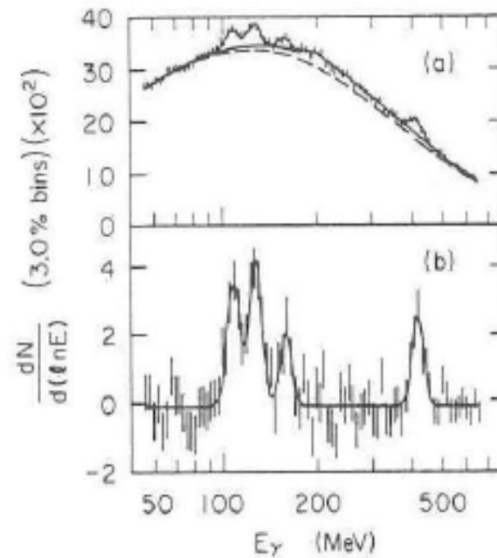

@TBA

Figure 11.2: The photon spectrum from  $\Upsilon'$  decays obtained by the Crystal Ball Collaboration at DORIS II. A triplet of lines corresponding to  $\Upsilon' \rightarrow \gamma\chi_b(^3P_{2,1,0})$  is seen between 100 and 200 MeV. The decays  $\chi_b \rightarrow \gamma\Upsilon$  produce the unresolved signal between 400 and 500 MeV [R. Nernst *et al.*, *Phys. Rev. Lett.* **54**, 2195 (1985)].

# Non-Perturbative QCD - I

177

Needed to deal with *bound states* and *soft interaction* regime

Very difficult problem

Different approaches available:

*Lattice QCD*

*Chiral Perturbation Theory*

*Non-Relativistic QCD*

*Heavy Quark Effective Theory*

...

Deep waters, not even surfed in this course

# Non Perturbative QCD - II

178

Perform QCD calculations over a discretized space-time (lattice)

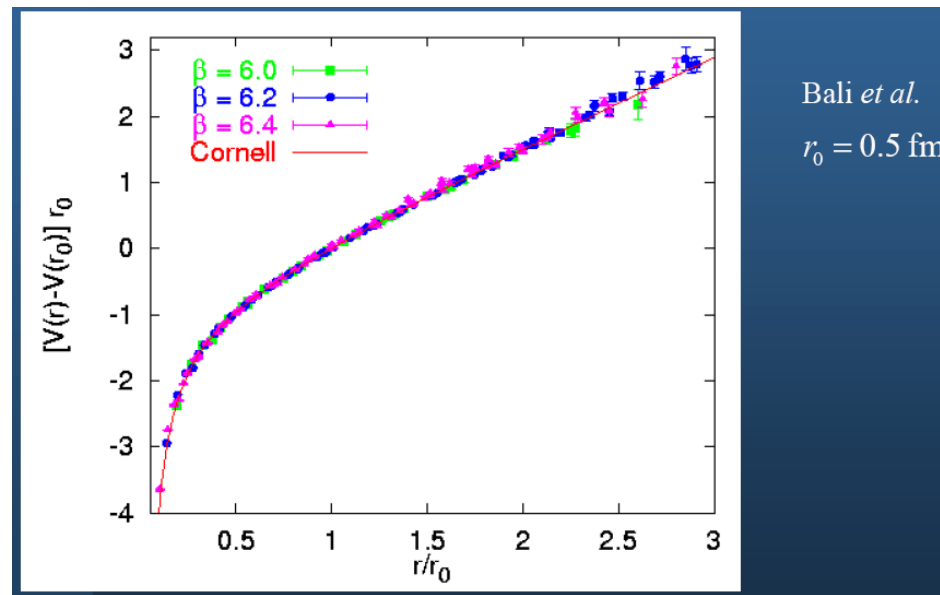

$q\bar{q}$  potential from lattice

$$V(r) = -\frac{4}{3} \frac{\alpha_s}{r} + ar : \text{ Not a bad idea after all...}$$

# Non Perturbative QCD - III

179

Examples:

Charmonium levels from lattice

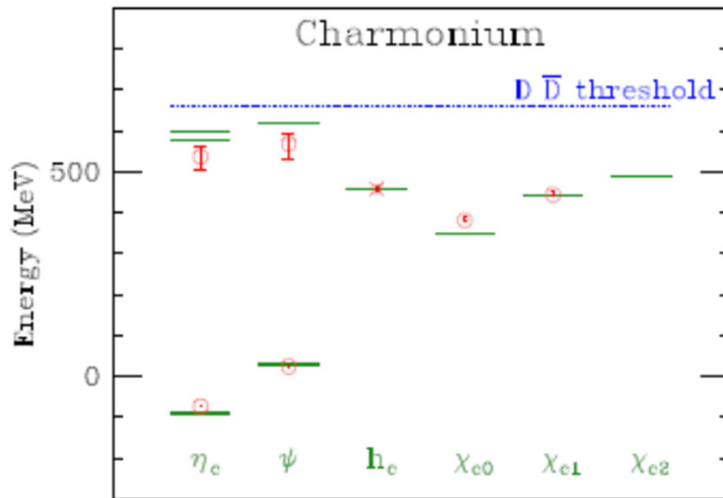

Predicted glueball spectrum from lattice

@TBA

