

Elementary Particles II

1 – QCD

Color, Gauge Fields, Gluons, Asymptotic Freedom,
Perturbative QCD, Confinement, Quarkonium

Re-examining the Evidence

Experiments probing the EM structure, like DIS:

Scaling of the structure functions:

Evidence for point-like, charged constituents

Like free particles when interacting with EM currents at high Q^2

Never observed outside hadrons → Tightly bound?

Experiments probing the strong interaction:

Large particle zoo

Evidence for highly symmetrical grouping and ordering

Strong suggestion of a substructure: Quarks

Funny, ad-hoc rules driving the observed symmetry

Constituents?

Besides the general, puzzling behavior observed, finally identify a number of serious problems, cast into a few issues:

Baryons and the Pauli Principle

R Ratio

π^0 Decay Rate

τ Lepton Branching Ratios

From all these questions a common conclusion:

Our picture of the quark model is not complete

Pauli Principle

Quark model:

Besides its many, remarkable successes, a central point is at issue:

The baryon wave function (space \times spin \times flavor) is symmetric

Pauli Principle seems to be lost, which is very bad news:

The Spin-Statistics Theorem is a consequence of very general principles of relativistic QFT,
not easily dismissed

R Ratio - I

Assume the process $e^+e^- \rightarrow \text{hadrons}$ to proceed at the lowest order through
 $e^+e^- \rightarrow q\bar{q} \rightarrow \text{hadrons}$

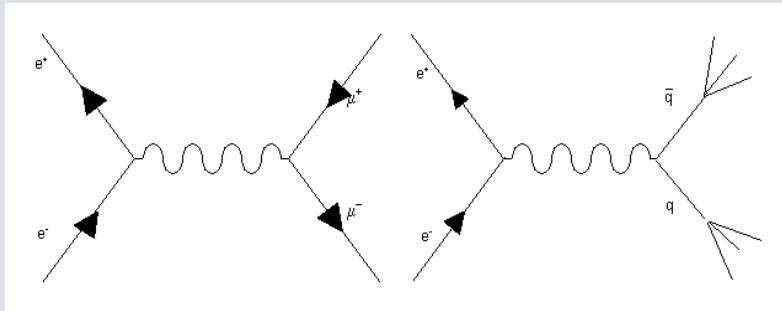

As for DIS:
 Don't care about quark *hadronization*, assume
 the time scales for hard and soft sub-processes
 to be wildly different

$$\sigma(e^+e^- \rightarrow \mu^+\mu^-) = \frac{4\pi\alpha^2}{3s}$$

$$\sigma(e^+e^- \rightarrow q\bar{q}) = \frac{4\pi\alpha^2 Q_q^2}{3s}, \quad Q_q = \text{quark charge in } e \text{ units}$$

$$R(E_{CM}) = \frac{\sigma(e^+e^- \rightarrow \text{adroni})}{\sigma(e^+e^- \rightarrow \mu^+\mu^-)} = \frac{\sum_q \sigma(e^+e^- \rightarrow q\bar{q})}{\sigma(e^+e^- \rightarrow \mu^+\mu^-)} = \sum_q Q_q^2$$

Sum extended to all accessible
 quark flavors $\rightarrow 2m_q < E_{CM}$

R Ratio - II

R counts the number of different quark species created at any given E_{CM} . Expect:

$$u, d \rightarrow R = \left(\frac{2}{3}\right)^2 + \left(-\frac{1}{3}\right)^2 = \frac{5}{9} \quad \text{Low energy}$$

$$u, d, s \rightarrow R = \left(\frac{2}{3}\right)^2 + \left(-\frac{1}{3}\right)^2 + \left(-\frac{1}{3}\right)^2 = \frac{6}{9} \quad E > 1-1.5 \text{ GeV}$$

$$u, d, s, c \rightarrow R = \left(\frac{2}{3}\right)^2 + \left(-\frac{1}{3}\right)^2 + \left(-\frac{1}{3}\right)^2 + \left(\frac{2}{3}\right)^2 = \frac{10}{9} \quad E > 3 \text{ GeV}$$

By taking 3 quark species
of any flavor:

$$u, d \rightarrow R = \frac{15}{9}$$

$$u, d, s \rightarrow R = \frac{18}{9}$$

$$u, d, s, c \rightarrow R = \frac{30}{9}$$

R Ratio - III

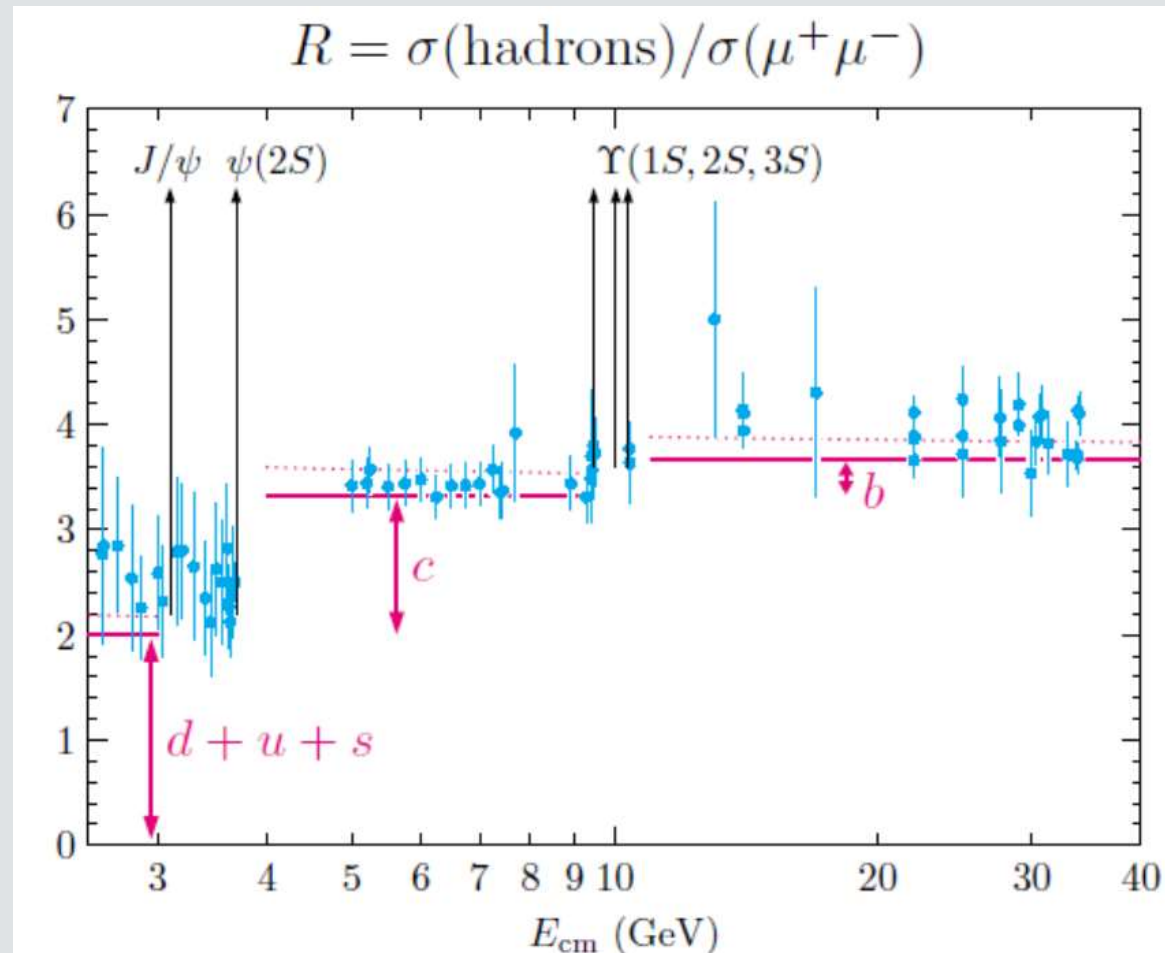

@TBA

π^0 Decay Rate - I

Originally calculated by taking p, \bar{p} in the triangle loop (Steinberger 1949)

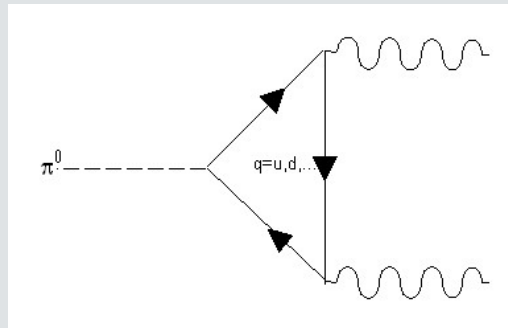

Steinberger's calculation:

Yukawa model to account for πpp vertex

Point-like nucleons \rightarrow QED couplings to photons

Nucleon current in the loop: 4-vector J^μ

[Actually *axial* vector, to match pion -ve parity]

π^0 spinless: Only 4-vector available p_μ

\rightarrow Decay amplitude $\sim p_\mu J^\mu$

π^0 Decay Rate - II

With a proton loop rate OK (!)

By naively replacing the proton loop by a quark loop:

$$J^\mu \approx \sum_{i=u}^d q_i \bar{\psi}_i \gamma^\mu \gamma^5 \psi_i = e \left(\frac{2}{3} \bar{u} \gamma^\mu \gamma^5 u - \frac{1}{3} \bar{d} \gamma^\mu \gamma^5 d \right)$$

Amplitude: 2 vertexes

Each vertex $\propto \sqrt{\alpha} = e \rightarrow$ Amplitude $\propto e^2$

Sum over light quarks u, d :

$$\sum_{i=u,d} a_i Q_i^2 = e^2 \left[1 \cdot \left(\frac{2}{3} \right)^2 - 1 \cdot \left(-\frac{1}{3} \right)^2 \right] = e^2 \left[\frac{4}{9} - \frac{1}{9} \right] = e^2 \frac{1}{3}$$

$$\Gamma_{quark} (\pi^0 \rightarrow \gamma\gamma) = \frac{1}{9} \Gamma_{proton} (\pi^0 \rightarrow \gamma\gamma) \quad ???$$

\rightarrow Wrong by a factor 9!

Bad news for the quark model

π^0 Decay Rate - III

Upon looking more carefully to the problem, things look actually even worse:

By taking seriously the quark model, one cannot escape consequences of approximate *chiral symmetry* of light quarks

Then simple guess on approximate symmetry of the initial state would lead to conclude *the neutral pion is stable!* Another quark model puzzle..

Explanation of this paradox led to discovery of the first *anomaly* in QFT (Adler, Bell & Jackiw) : Actually related to a wrong integral...

Advanced topic, quite relevant to the Standard Model:

Quantum field theories must be *anomaly free* in order to be renormalizable

Interesting conditions for SM to be anomaly free, including *charge quantization*

π^0 Decay Rate - IV

Direct method:

π^0 produced in a first thin foil, when not decayed do not contribute to e^+ yield from γ conversion in a second thin foil

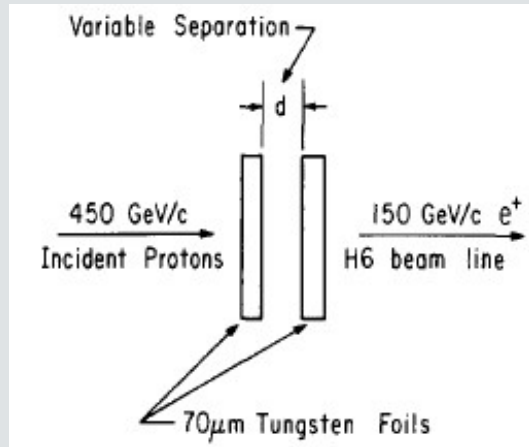

$$Y(d) = N \{ A + B [1 - \exp(-d/\lambda)] \}$$

$$\lambda = \beta \gamma c \tau \simeq \gamma c \tau \quad \text{Energy dependent}$$

Use known energy spectra for pions

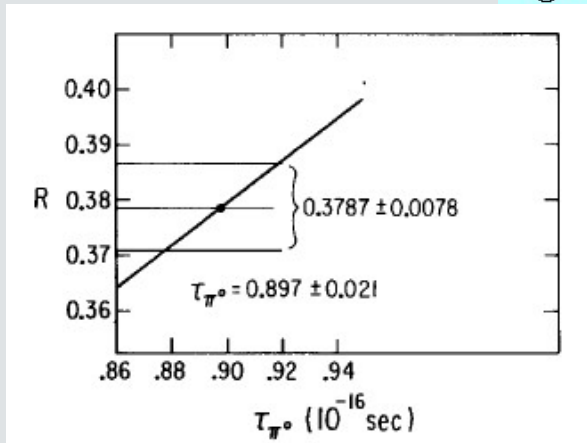

$$\tau = 0.897 \pm .021 \cdot 10^{-16} \text{ s}$$

$$\Gamma = 7.34 \pm 0.18 \pm 0.11 \text{ eV}$$

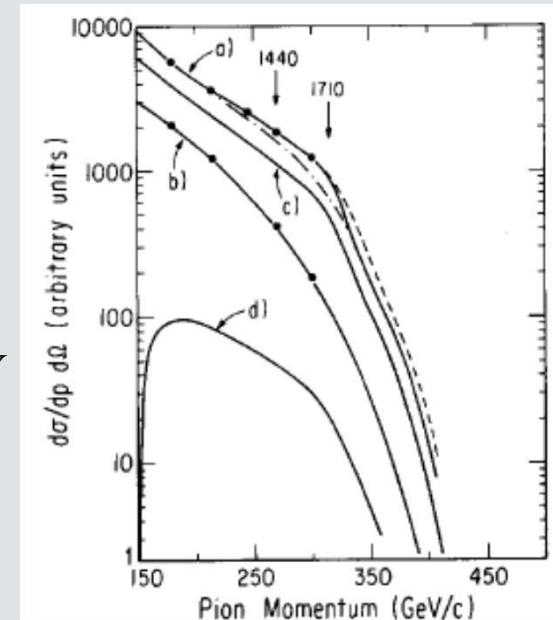

π^0 Decay Rate - V

Primakoff effect

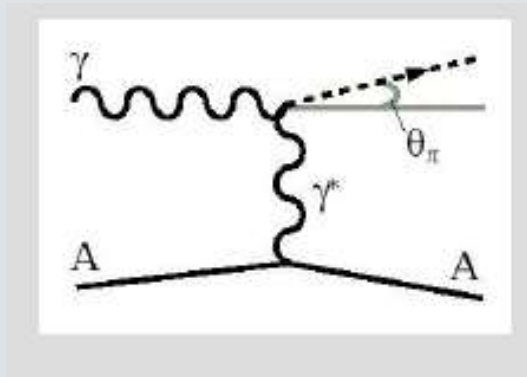

Very simple idea:

Get a high energy photon beam + high Z target

Pick-up a virtual photon from the nuclear Coulomb field

2-photon coupling will (sometimes) create a π^0

$$\frac{d\sigma_{\text{Prim}}}{d\Omega_{\text{LAB}}} \simeq \Gamma_{\pi^0 \rightarrow \gamma\gamma} Z^2 \frac{8\alpha E^4}{m_{\pi^0}^2} \frac{|F(q^2)|^2}{q^4} \sin^2 \theta_{\pi^0}$$

Strongly forward peaked

Quickly increasing with energy

Strongly Z dependent: Coherence

$\Gamma = 1/\tau$ extracted by measuring the differential cross-section

Nuclear form factor required

π^0 Decay Rate - VI

Recent experiment: PrimEx at Jefferson Lab (Virginia)

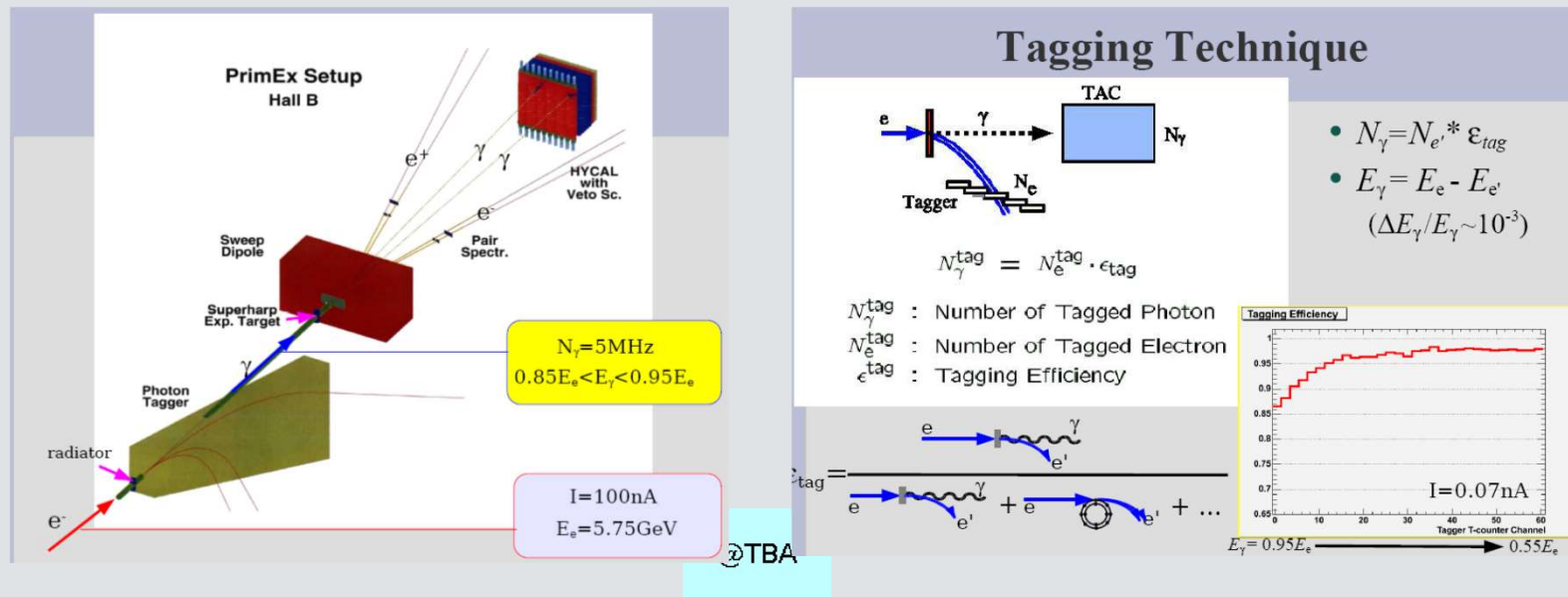

τ Lepton Decays

τ . Heavy brother of e and μ

$m_\tau = 1776$ MeV

Weak decays:

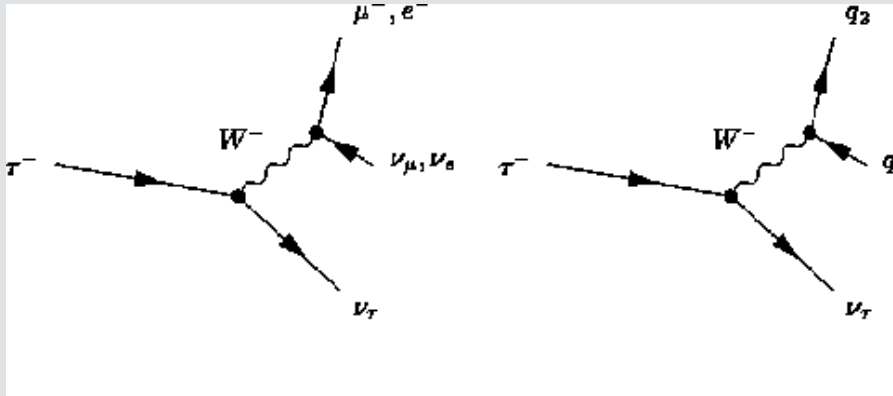

@TBA

$q, \bar{q} : u, d, s$

$BR(e) \sim 18\%$

$BR(\mu) \sim 17\%$

$BR(q\bar{q}) \sim 65\%$

In the absence of color, weak interaction universality would lead to predict:

$$BR(e) \sim BR(\mu) \sim BR(q\bar{q}) \sim 33\%$$

With color:

$$\Gamma(q\bar{q}) \sim 3 \Gamma(l\bar{l}) \rightarrow BR(q\bar{q}) \sim \frac{3 \Gamma(l\bar{l})}{3 \Gamma(l\bar{l}) + 2 \Gamma(l\bar{l})} \sim 60\% \text{ OK}$$

Color - I

New hypothesis:

There is a new degree of freedom for quarks: Color

Each quark can be found in one of 3 different states
Internal space (mathematically identical to flavor):

States = 3-component complex vectors

Base states:

$$R(ed) = \begin{pmatrix} 1 \\ 0 \\ 0 \end{pmatrix}, G reen) = \begin{pmatrix} 0 \\ 1 \\ 0 \end{pmatrix}, B(lue) = \begin{pmatrix} 0 \\ 0 \\ 1 \end{pmatrix}$$

Needless to say, nothing to do with our old, beloved color concept (nature, art, politics..):

Just a *name* for another, non-classical property of hadron constituents

Color - II

Provided one can build a color wave function for 3 fermions which is antisymmetric, the Fermi statistics problem is solved

Total wave function of a baryon

$$\psi = \psi_{color} \underbrace{\psi_{orbital} \psi_{spin} \psi_{flavor}}_{\text{Symmetric}} \rightarrow \psi_{color}: \text{Antisymmetric}$$

To account for 3 different color states, the R ratio must be multiplied by 3 \rightarrow OK with experimental data

Just the same conclusion for hadronic τ decays: Multiply rate by 3

The correct π^0 rate is obtained by inserting a factor 9

Color - III

Observe:

When computing R , τ decay rates we add the *rates* for different colors
→Factor $\times 3$

We deal with quarks as with real, on-shell particles: Ignore fragmentation

When computing π^0 decay rate, we add the *amplitudes*
→Factor $\times 9$

Quarks in the loop are virtual particles: Amplitudes interfere

Color - IV

Must be possible to build hadron states as color *singlets*

Do not expect hadrons to fill larger irr.reps.:

Would imply large degeneracies for hadron states, not observed

In other words:

Color is fine, but we do not observe any colored hadron

How colored hadrons would show up?

Just as an example:

Should the nucleon fill the $\mathbf{3}$ of $SU(3)_C$, there would be 3 different species of protons and neutrons.

Then each nucleon level in any nucleus could accommodate 3 particles instead of one:

The nuclear level scheme would be far different from the observed one

Color - V

Therefore we assume the color charge is *confined*:
Never observed directly, as it is the electric charge

Why? For the moment, nobody really knows

So color charge is a counterintuitive property of quarks (and gluons: see later):

Colored constituents cannot be directly observed

Unsatisfactory?

Our idea of what is a respectable property for a constituent particle:
Based on our experience with gravity and electromagnetism,
both unconfining interactions with a good, intuitive, observable classical limit

But: Gravity and EM are not the last word about interactions...

Color - VI

Guess $SU(3)$ as the color group

Take the two fundamental decompositions:

$$\mathbf{3} \otimes \mathbf{3} \otimes \mathbf{3} = \mathbf{1} \oplus \mathbf{8} \oplus \mathbf{8} \oplus \mathbf{10} \quad \text{Baryons}$$

$$\mathbf{3} \otimes \mathbf{3}^* = \mathbf{1} \oplus \mathbf{8} \quad \text{Mesons}$$

Both feature a singlet in the direct sum: OK

No singlets in $\mathbf{3} \otimes \mathbf{3}$: OK

Can't say the same for other groups...

Take $SU(2)$ as an example:

Say the quarks live in the adjoint $SU(2)$ representation, $\mathbf{3}$

Then for qq

$$\mathbf{3} \otimes \mathbf{3} = \mathbf{1} \oplus \mathbf{3} \oplus \mathbf{5}$$

Observe: This is $\mathbf{3}$ of $SU(2)$, which is quite different from $\mathbf{3}$ of $SU(3)$

Diquarks can be in color singlet

→Should find diquarks as commonly as baryons or mesons..

Colored Quarks

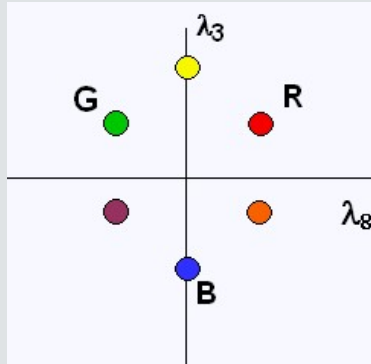

$$I_3^c = \frac{\lambda_3}{2}, \quad Y^c = \frac{\lambda_8}{\sqrt{3}}$$

	I_3^c	Y^c		I_3^c	Y^c
R	$+1/2$	$+1/3$	\bar{R}	$-1/2$	$-1/3$
G	$-1/2$	$+1/3$	\bar{G}	$+1/2$	$-1/3$
B	0	$-2/3$	\bar{B}	0	$+2/3$

$SU(3)_C$ is an *exact symmetry*:

$$m_u^{(R)} = m_u^{(G)} = m_u^{(B)}, \dots$$

Beware: $SU(3)_C$ has nothing to do with $SU(3)_F$:

Quark quantum numbers are independent from their color state

They are left unchanged by QCD transitions

Uncolored Hadrons

According to our fundamental hypothesis:

$$\text{Mesons: } \mathbf{3} \otimes \mathbf{3}^* = \mathbf{1} \oplus \mathbf{8}$$

$$\rightarrow \psi_c = \frac{1}{\sqrt{3}} (R\bar{R} + G\bar{G} + B\bar{B})$$

$$\text{Baryons: } \mathbf{3} \otimes \mathbf{3} \otimes \mathbf{3} = \mathbf{1} \oplus \mathbf{8} \oplus \mathbf{8} \oplus \mathbf{10}$$

$$\rightarrow \psi_c = \frac{1}{\sqrt{6}} (RGB - RBG + GBR - GRB + BRG - BGR)$$

In both cases, pick singlet

Mesons: *No particular exchange symmetry*
(2 non identical particles)

Baryons: *Fully antisymmetrical color wave function*
(3 identical particles)

Color Interaction: QCD

Color: A new degree of freedom for quarks
Compare to other quantum numbers:

Baryonic/Leptonic numbers
Conserved, *not originating interactions*

Electric charge
Conserved, *origin of the electromagnetic field*

A deep question:

What is the true origin of the electromagnetic interaction?

We have freely used the interaction term $j^\mu A_\mu$, only based on the classical analogy:

But supposedly quantum mechanics is more general than classical mechanics/electromagnetism..

Is there any deeper origin for it?

QED as a Gauge Theory - I

By sticking for a moment to (deprecated) wave function language in our relativistic environment, remember a very general property: Absolute phase not defined for a wave function.

Indeed:

$$L_0 = \bar{\psi}(x)(i\gamma^\mu \partial_\mu - m)\psi(x) \quad \text{Free Dirac Lagrangian}$$

Global gauge (=Phase) transformation:

$$G: \psi(x) \rightarrow \psi'(x) = U_\theta \psi(x) = e^{-iq\theta} \psi(x), \quad q\theta: \text{New phase} \propto \text{Charge}$$

$\rightarrow L_0$ invariant wrt G

Just meaning:

Take *all* particle states, re-phase each state proportionally to its charge
Then expect a *global* conservation law (← Noether's theorem):

$$\sum q = \text{constant}$$

→ Electric charge conservation

This can be easily re-phrased in full field theory language:

Same result

QED as a Gauge Theory - II

Now this is not really satisfactory:

Global re-phasing of wave functions just clashes with Lorentz invariance, so charge conservation would be awfully frame dependent

→ Generalize to *local* phase transformation:

$G_L : \psi(x) \rightarrow \psi'(x) = U_\theta \psi(x) = e^{-iq\theta(x)} \psi(x)$ Local gauge transformation

→ L_0 not invariant wrt G_L : Derivative term troublesome

$$L_0 = \bar{\psi}(x) (i\gamma^\mu \partial_\mu - m) \psi(x) \rightarrow L_0' = i\bar{\psi}(x) e^{+iq\theta(x)} \gamma^\mu \partial_\mu (e^{-iq\theta(x)} \psi(x)) - m\bar{\psi}(x) \psi(x)$$

$$L_0' = i[\bar{\psi}(x) \gamma^\mu \partial_\mu \psi(x) - iq \partial_\mu [\theta(x)] \psi(x)] - m\bar{\psi}(x) \psi(x)$$

$$L_0' = \{i\bar{\psi}(x) \gamma^\mu \partial_\mu \psi(x) + q \partial_\mu [\theta(x)] \psi(x) - m\bar{\psi}(x) \psi(x)\}$$

$$L_0' = [i\bar{\psi}(x) \gamma^\mu \partial_\mu \psi(x) - m\bar{\psi}(x) \psi(x)] + q \partial_\mu [\theta(x)] \psi(x) \neq L_0$$

→ Local gauge invariance cannot hold in a world of free particles

Gauge symmetry requires interaction

QED as a Gauge Theory - III

New transformation rule:

$$\begin{cases} \psi(x) \rightarrow \psi'(x) = U_\theta \psi(x) = e^{-iq\theta(x)} \psi(x) & \text{As before} \\ A_\mu(x) \rightarrow A_\mu(x) + q \partial_\mu \theta(x) & \text{New character in the comedy} \end{cases}$$

Equivalent to re-define derivative for ψ :

$$\partial_\mu \rightarrow \partial_\mu + iqA_\mu \quad \text{Vector field}$$

Add a new term to Lagrangian:

$$L_i = - \underbrace{q \bar{\psi}(x) \gamma^\mu \psi(x)}_{j^\mu} A_\mu \quad \text{Interaction term}$$

Same as classical electrodynamics

$$L_0 = \bar{\psi}(x) (i\gamma^\mu \partial_\mu - m) \psi(x) \rightarrow L_0 + L_i = \bar{\psi}(x) (i\gamma^\mu \partial_\mu - m) \psi(x) - q \bar{\psi}(x) \gamma^\mu \psi(x) A_\mu$$

Sum is invariant

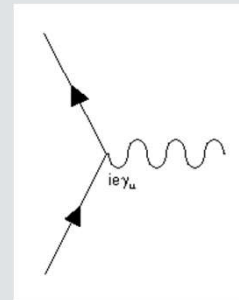

QED as a Gauge Theory - IV

...And another one:

$$-\frac{1}{4}F^{\mu\nu}F_{\mu\nu}, \quad F^{\mu\nu} = \partial^\mu A^\nu - \partial^\nu A^\mu \quad \text{Field energy}$$

Must be there because the field carries energy+momentum+angular momentum

Reminder:

$F^{\mu\nu}$ is the EM field

$$F^{\mu\nu} = \begin{pmatrix} 0 & -E_x & -E_y & -E_z \\ E_x & 0 & -B_z & B_y \\ E_y & B_z & 0 & -B_x \\ E_z & -B_y & B_x & 0 \end{pmatrix}$$

Field must be massless to have L gauge invariant

$$\frac{1}{2}m^2 A_\mu^2 \rightarrow \frac{1}{2}m^2 (A_\mu(x) + q \partial_\mu \theta(x))^2 \neq \frac{1}{2}m^2 A_\mu^2 \quad \text{if } m \neq 0$$

QED as a Gauge Theory - V

Consider all the phase transformations as defined before:

$$\psi(x) \rightarrow \psi'(x) = U_\theta \psi(x) = e^{-iq\theta(x)} \psi(x)$$

The full set is a group: $U(1)$ Unitary, 1-dimensional

$$e^{-iq\theta_1(x)} e^{-iq\theta_2(x)} \psi(x) = e^{-iq[\theta_1(x)+\theta_2(x)]} \psi(x) \in U(1)$$

1 parameter: $\theta(x)$

$$\text{Abelian: } e^{-iq\theta_1(x)} e^{-iq\theta_2(x)} \psi(x) = e^{-iq\theta_2(x)} e^{-iq\theta_1(x)} \psi(x)$$

$U(1)$ is the (Abelian) *gauge group* of QED

Equivalent to $SO(2)$, group of 2D rotations

QCD as a Gauge Theory - I

Extend gauge transformations to a 3-component wave function:

$$\Psi \equiv \begin{pmatrix} \psi_R \\ \psi_G \\ \psi_B \end{pmatrix}$$

Global gauge transformation: Phase change for individual components

→ Phase change will mix color components

$$G_G^C : \Psi(x) \rightarrow \Psi'(x) = U_G \cdot \Psi(x) = e^{-ig\mathbf{M}} \cdot \Psi(x) \quad U_G \text{ unitary} \rightarrow \mathbf{M} \text{ Hermitian}$$

$$e^{-ig\mathbf{M}} = \mathbf{1} - ig\mathbf{M} + \frac{(-ig\mathbf{M})^2}{2!} + \dots \quad \mathbf{M} : 3 \times 3 \text{ Hermitian matrix}$$

\mathbf{M} acting on the 3 color components of the quark state

Since the color symmetry group is $SU(3)_C$, for any hermitian \mathbf{M} :

$$\mathbf{M} = \sum_{i=1}^8 \lambda_i \theta_i \equiv \vec{\lambda} \cdot \vec{\theta}$$

$\vec{\lambda}$: Vector of 8 3×3 Gell-Mann matrices; $\vec{\theta}$: Vector of 8 parameters

QCD as a Gauge Theory - II

As for QED, extend to *local* gauge transformations

As before, in order to guarantee invariance of L :

→ Re-define derivative adding new vector fields:

$$\partial_\mu \rightarrow \partial_\mu \mathbf{1} + ig\mathbf{C}_\mu$$

$$\mathbf{C}_\mu : \begin{cases} \text{4-vector field} & \text{Lorentz structure} \\ \text{Matrix} \in SU(3)_C & \text{Color space} \end{cases}$$

We know how to express any Hermitian matrix $\in SU(3)_C$:

Use $SU(3)_C$ generators → Gell-Mann matrices

$$\rightarrow \mathbf{C}_\mu = \frac{1}{2} \sum_{a=1}^8 G_\mu^a \boldsymbol{\lambda}_a \equiv \vec{G}_\mu \cdot \vec{\boldsymbol{\lambda}} \quad \text{8 fields required: Gluons}$$

So gluons are a bit like 8 different “photons”, exchanged between color charges

But: *They are non Abelian*

QCD as a Gauge Theory - III

Local gauge transformation for $SU(3)_C$:

$$\left\{ \begin{array}{l} \Psi(x) \rightarrow \Psi'(x) = U_\theta \Psi(x) = e^{-ig\vec{\lambda}\cdot\vec{\theta}(x)} \Psi(x) \\ G_\mu^a(x) \rightarrow G_\mu^a(x) + \partial_\mu \theta^a + g \sum_{b,c=1}^8 f^{abc} G_\mu^b(x) \theta^c(x) \quad a=1,\dots,8 \end{array} \right. \quad \begin{array}{l} \text{Very important: New term, coming from } SU(3) \\ \text{being non Abelian} \end{array}$$

Reminder:

$$\left[\frac{\lambda_a}{2}, \frac{\lambda_b}{2} \right] = if^{abc} \frac{\lambda_c}{2} \quad f^{abc}: SU(3) \text{ structure constants}$$

$$L_0 = \bar{\Psi}(x) (i\gamma^\mu \partial_\mu - m) \Psi(x) \rightarrow L_0 + L_i$$

$$L_i = -g \underbrace{\left[\bar{\Psi}(x) \gamma^\mu \left(\frac{\vec{\lambda}}{2} \right) \Psi(x) \right]}_{\vec{J}_\mu} \cdot \vec{G}_\mu \quad \text{Interaction term}$$

$$-\frac{1}{4} \vec{G}_{\mu\nu} \cdot \vec{G}^{\mu\nu} = -\frac{1}{4} \sum_{a=1}^8 G_{\mu\nu}^a \cdot G^{a\mu\nu} \quad \text{Field energy term}$$

QCD as a Gauge Theory - IV

Take the expression of fields in terms of potentials:

$$G_{\mu\nu}^a = \partial_\mu G_\nu^a - \partial_\nu G_\mu^a - g \sum_{b,c=1}^8 f_{abc} G_\mu^b G_\nu^c$$

Very important: *Absent in QED* ($f=0$)

New term, coming from $SU(3)$ being non Abelian

$$\rightarrow G_{\mu\nu}^a G_{\mu\nu}^a \text{ contains terms with } \underbrace{\partial_\mu G_\nu^a \cdot G_\mu^b G_\nu^c}_{3 \text{ gluons}}, \underbrace{G_\mu^b G_\nu^c \cdot G_\mu^b G_\nu^c}_{4 \text{ gluons}}$$

When translated into Feynman rules/diagrams, these pieces of L correspond to 3 and 4 gluons vertices

So:

The form of QCD Lagrangian leads to predict the existence of a new kind of *gluon-gluon color interaction*

QCD as a Gauge Theory - V

Since color interaction is tied to color charge, we are saying *the gluons carry their own color charge*

Sounds unfamiliar? Well, that's all after playing with a non-Abelian gauge group.

Unlike the electric charge, color charge can manifest itself in more than one way.

Indeed, gluons carry a type of color charge different from quarks/antiquarks:

Color + Anticolor

QCD as a Gauge Theory - VI

QCD Vertexes

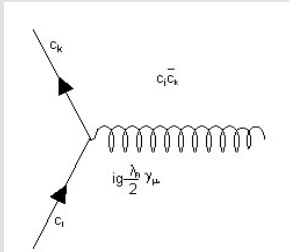

$$ig \frac{\lambda_a}{2} \gamma_\mu \quad \text{Similar to QED:}$$

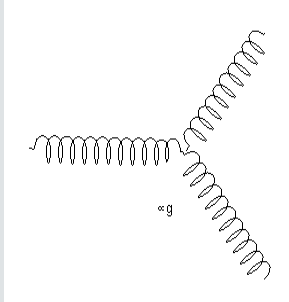
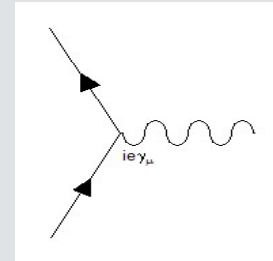

$$\propto g \quad (\text{Lorentz structure not shown})$$

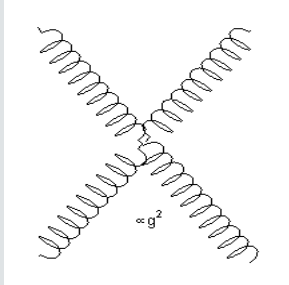

$$\propto g^2 \quad (\text{Lorentz structure not shown})$$

Colored Gluons - I

Compare to mesons in $SU(3)_F$: *Flavor + Antiflavor*
But: *Gluons are not bound states of Color+Anticolor!*

Still, they share the same math:

Gluons live in the adjoint (**8**) irr.rep. of $SU(3)_C$

$$|1\rangle = \frac{1}{\sqrt{2}}(r\bar{b} + b\bar{r}), |2\rangle = -\frac{i}{\sqrt{2}}(r\bar{b} - b\bar{r}), |3\rangle = \frac{1}{\sqrt{2}}(r\bar{r} - b\bar{b})$$

$$|4\rangle = \frac{1}{\sqrt{2}}(r\bar{g} + g\bar{r}), |5\rangle = -\frac{i}{\sqrt{2}}(r\bar{g} - g\bar{r}), |6\rangle = \frac{1}{\sqrt{2}}(b\bar{g} + g\bar{b})$$

$$|7\rangle = -\frac{i}{\sqrt{2}}(b\bar{g} - g\bar{b}), |8\rangle = \frac{1}{\sqrt{6}}(r\bar{r} + b\bar{b} - 2g\bar{g})$$

Colored Gluons - II

A very natural question: Gluons couple to $q\bar{q}$

Since one can decompose the total $q\bar{q}$ color state as:

$$\mathbf{3} \otimes \mathbf{3}^* = \mathbf{1} \oplus \mathbf{8}$$

Then: Where is the singlet gluon?

Does not exist: There are only 8 gluons, not 9

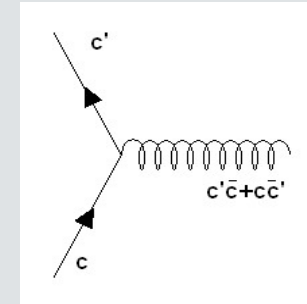

Should the singlet gluon actually exist, it would behave more or less like a “photon”:

Would be ‘white’ (= Singlet)

Would couple to color charges in the same way as photon couples to electric charges

Would give rise to a sort of “QED-like”, long range color interaction, not observed

Colored Gluons - III

Non Abelian vertices: Gluon-Gluon scattering *at tree level* (no loops)

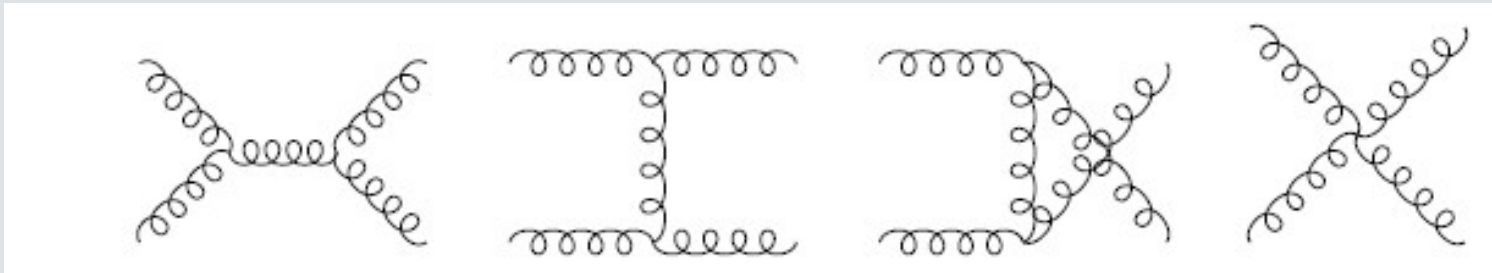

@TBA

Vertexes:

3 – gluons : $A \propto g$

4 – gluons : $A \propto g^2$

Compare:

In QED, photon-photon scattering amplitude occurs at order α^2 through the 1-loop diagram

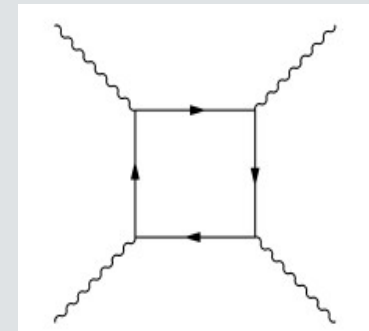

Comparing QED and QCD - I

Compare the different situations:

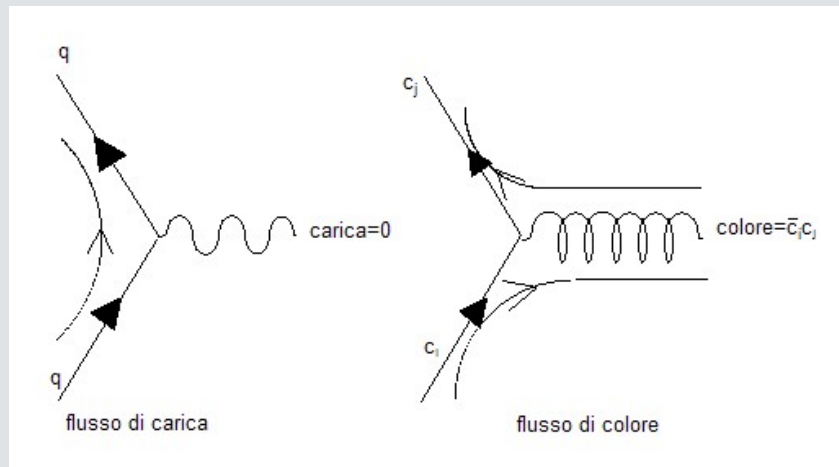

QED
Photon is *neutral*

Neither sourcing,
nor sinking charge

QCD
Gluon is *colored*

Sourcing color,
sinking anti-color

Comparing QED and QCD - II

Comparison of coupling constants:

α vs. α_s Adimensional constants (*Interaction strength*)

Can define elementary charge in terms of α , α_s

Measure particle charge by its ratio to elementary charge:

Number

What are the allowed values for these numbers?

Comparing QED and QCD - III

QED: Gauge group is *Abelian*

Electric charge can be *any* number:

No reason for charge quantization → So electric charge quantization is a bit of a mystery

[Tricky business: Sticking to perturbation theory, one must have the SM *anomaly-free* in order to enable renormalization → This in turn *requires* charge quantization.

But: Is the SM just perturbation theory?

At a fundamental level, Grand Unified Theories explain charge quantization based on larger symmetry groups like $SU(5)$.

But: They fail to explain proton stability]

Photon charge is strictly 0

QCD: Gauge group is *non Abelian*

“Color charge” value is *fixed* for every representation

Quarks: $\mathbf{3}, \mathbf{3}^* \rightarrow Q = 4/3$

Gluons: $\mathbf{8} \rightarrow Q = 3$

Similar to $I(I+1)$ for any isospin ($SU(2)$) multiplet

Color Factors - I

Consider the static interaction between 2 charges:

QED

For fixed $|q|$, the 'charge factor' can be defined as:

$$f_{12} = \frac{q_1 q_2}{|q|^2} = \begin{cases} +1 & q_1 q_2 > 0 \\ -1 & q_1 q_2 < 0 \end{cases}$$

Very simple for an Abelian interaction

QCD The 'color factor' depends on the irr.rep. of the color state

Representation dependent

Identical for any transition in a given representation

→Color Conservation

Less simple in this non-Abelian interaction

Color Factors - II

$$q\bar{q} \rightarrow q\bar{q}$$

$$\mathbf{3} \otimes \mathbf{3}^* = \mathbf{1} \oplus \mathbf{8}$$

Total color conservation: $\begin{cases} \mathbf{1} \rightarrow \mathbf{1} \\ \mathbf{8} \rightarrow \mathbf{8} \end{cases}$

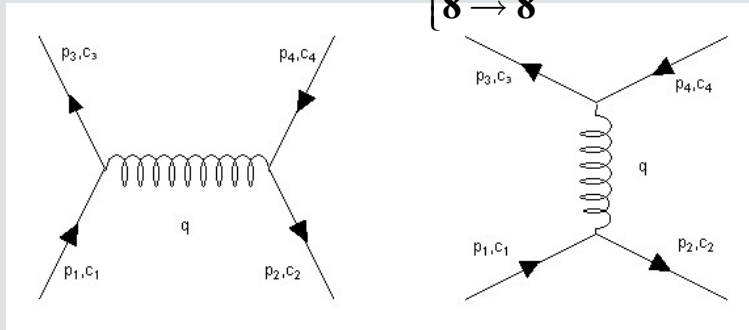

Observe:

Similar to conservation of total I-spin

$$T_{fi} = i \sum_{\alpha, \beta=1}^8 \underbrace{[\bar{u}(3)c_3^\dagger] \left[-i \frac{g_s}{2} \lambda^\alpha \gamma^\mu \right] [u(1)c_1]}_{\text{color current}} \underbrace{\left[-i \frac{g_{\mu\nu} \delta^{\alpha\beta}}{q^2} \right]}_{\text{propagator}} \underbrace{[\bar{v}(2)c_2^\dagger] \left[-i \frac{g_s}{2} \lambda^\beta \gamma^\nu \right] [v(4)c_4]}_{\text{color current}}$$

Sum is over all 8 color matrices

c_i are the color states of initial, final $q\bar{q}$

$$T_{fi} = \frac{-g_s^2}{q^2} [\bar{u}(3)\gamma^\mu u(1)] [\bar{v}(2)\gamma_\mu v(4)] \underbrace{\frac{1}{4} \sum_{\alpha} [c_3^\dagger \lambda^\alpha c_1] [c_2^\dagger \lambda^\alpha c_4]}_{\text{color factor}}$$

Color Factors - III

Octet

$r\bar{b}$

Just as an example: Result is the same for all octet states

$$\left. \begin{array}{l} c_1 = c_3 = \begin{pmatrix} 1 \\ 0 \\ 0 \end{pmatrix} \\ c_2 = c_4 = \begin{pmatrix} 0 \\ 1 \\ 0 \end{pmatrix} \end{array} \right\} \rightarrow f = \frac{1}{4} \sum_{\alpha=1}^8 (1 \ 0 \ 0) \lambda^\alpha \begin{pmatrix} 1 \\ 0 \\ 0 \end{pmatrix} (0 \ 1 \ 0) \lambda^\alpha \begin{pmatrix} 0 \\ 1 \\ 0 \end{pmatrix}$$

$$\rightarrow f = \frac{1}{4} \sum_{\alpha=1}^8 \lambda_{11}^\alpha \lambda_{22}^\alpha = \frac{1}{4} (\lambda_{11}^3 \lambda_{22}^3 + \lambda_{11}^8 \lambda_{22}^8) = -\frac{1}{6}$$

Color Factors - IV

Singlet

$$\frac{1}{\sqrt{3}}(r\bar{r} + b\bar{b} + g\bar{g}) \quad \text{Only this state in the singlet}$$

But: *Any* component can go into *any other*..

$$f_i = \frac{1}{4} \frac{1}{\sqrt{3}} \frac{1}{\sqrt{3}} \sum_{j=1}^3 \sum_{\alpha=1}^8 [c_i^\dagger \lambda^\alpha c_j] [c_j^\dagger \lambda^\alpha c_i], \quad i=1,2,3$$

$$f = \sum_{i=1}^3 f_i = \frac{1}{4} \frac{1}{\sqrt{3}} \frac{1}{\sqrt{3}} \sum_{\alpha=1}^8 \sum_{i,j=1}^3 \lambda_{ij}^\alpha \lambda_{ji}^\alpha = \frac{1}{12} \sum_{\alpha=1}^8 \text{Tr}(\lambda^\alpha \lambda^\alpha)$$

$$\text{Tr}(\lambda^\alpha \lambda^\beta) = 2\delta^{\alpha\beta} \rightarrow \sum_{\alpha=1}^8 \text{Tr}(\lambda^\alpha \lambda^\alpha) = 16$$

$$\rightarrow f = \frac{4}{3}$$

Color Factors - V

$qq \rightarrow qq$

$$\mathbf{3} \otimes \mathbf{3} = \mathbf{3}^* \oplus \mathbf{6}$$

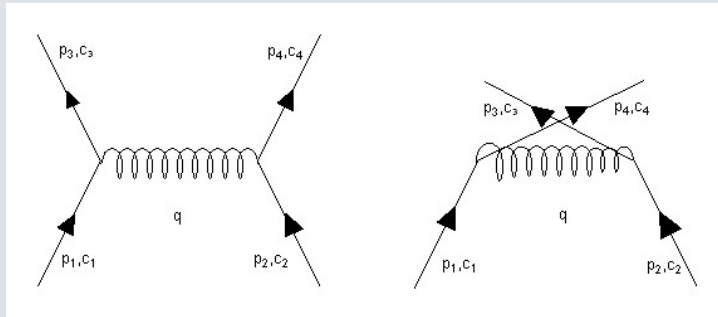

$$T_{fi} = \frac{-g_s^2}{q^2} [\bar{u}(3) \gamma^\mu u(1)] [\bar{u}(4) \gamma_\mu u(2)] \underbrace{\frac{1}{4} \sum_{\alpha=1}^8 [c_3^\dagger \lambda^\alpha c_1] [c_4^\dagger \lambda^\alpha c_2]}_{\text{color factor}}$$

$$f_{qq} = \frac{1}{4} \sum_{\alpha=1}^8 (c_3^\dagger \lambda^\alpha c_1) (c_4^\dagger \lambda^\alpha c_2)$$

Color Factors - VI

Color states: Triplet and sextet:

$$\mathbf{3}^*: \quad \frac{1}{\sqrt{2}}(rb - br), \frac{1}{\sqrt{2}}(bg - gb), \frac{1}{\sqrt{2}}(gr - rg)$$

Antisymmetric

$$\mathbf{6}: \quad rr, bb, gg, \frac{1}{\sqrt{2}}(rb + br), \frac{1}{\sqrt{2}}(bg + gb), \frac{1}{\sqrt{2}}(gr + rg)$$

Symmetric

Color Factors - VII

Sextet

rr

Just as an example: Result is the same for all sextet states

$$c_1 = c_2 = c_3 = c_4 = \begin{pmatrix} 1 \\ 0 \\ 0 \end{pmatrix}$$

$$f = \frac{1}{4} \sum_{\alpha=1}^8 \left[(1 \ 0 \ 0) \lambda^\alpha \begin{pmatrix} 1 \\ 0 \\ 0 \end{pmatrix} \right] \left[(1 \ 0 \ 0) \lambda^\alpha \begin{pmatrix} 1 \\ 0 \\ 0 \end{pmatrix} \right] = \frac{1}{4} \sum_{\alpha=1}^8 (\lambda_{11}^\alpha \lambda_{11}^\alpha)$$
$$= \frac{1}{4} (\lambda_{11}^3 \lambda_{11}^3 + \lambda_{11}^8 \lambda_{11}^8) = \frac{1}{3}$$

Color Factors - VIII

Triplet

$$\frac{1}{\sqrt{2}}(rb - br)$$

Just as an example as before

$$f = \frac{1}{4} \frac{1}{\sqrt{2}} \frac{1}{\sqrt{2}} \sum_{\alpha=1}^8$$

$$\left\{ \left[\begin{array}{ccc} (1 & 0 & 0) \lambda^\alpha \\ & \begin{pmatrix} 1 \\ 0 \\ 0 \end{pmatrix} \end{array} \right] \left[\begin{array}{ccc} (0 & 1 & 0) \lambda^\alpha \\ & \begin{pmatrix} 0 \\ 1 \\ 0 \end{pmatrix} \end{array} \right] - \left[\begin{array}{ccc} (0 & 1 & 0) \lambda^\alpha \\ & \begin{pmatrix} 1 \\ 0 \\ 0 \end{pmatrix} \end{array} \right] \left[\begin{array}{ccc} (1 & 0 & 0) \lambda^\alpha \\ & \begin{pmatrix} 0 \\ 1 \\ 0 \end{pmatrix} \end{array} \right] \right.$$

$$\left. - \left[\begin{array}{ccc} (1 & 0 & 0) \lambda^\alpha \\ & \begin{pmatrix} 0 \\ 1 \\ 0 \end{pmatrix} \end{array} \right] \left[\begin{array}{ccc} (0 & 1 & 0) \lambda^\alpha \\ & \begin{pmatrix} 1 \\ 0 \\ 0 \end{pmatrix} \end{array} \right] - \left[\begin{array}{ccc} (0 & 1 & 0) \lambda^\alpha \\ & \begin{pmatrix} 0 \\ 1 \\ 0 \end{pmatrix} \end{array} \right] \left[\begin{array}{ccc} (1 & 0 & 0) \lambda^\alpha \\ & \begin{pmatrix} 1 \\ 0 \\ 0 \end{pmatrix} \end{array} \right] \right\}$$

$$f = \frac{1}{8} \sum_{\alpha=1}^8 \{ \lambda_{11}^\alpha \lambda_{22}^\alpha - \lambda_{21}^\alpha \lambda_{12}^\alpha - \lambda_{12}^\alpha \lambda_{21}^\alpha + \lambda_{22}^\alpha \lambda_{11}^\alpha \}$$

$$\rightarrow f = \frac{1}{4} \sum_{\alpha=1}^8 \{ \lambda_{11}^\alpha \lambda_{22}^\alpha - \lambda_{12}^\alpha \lambda_{21}^\alpha \} = \frac{1}{4} \{ \lambda_{11}^3 \lambda_{22}^3 + \lambda_{11}^8 \lambda_{22}^8 - \lambda_{12}^1 \lambda_{21}^1 - \lambda_{12}^2 \lambda_{21}^2 \} = -\frac{2}{3}$$

Color Factors - IX

Matrix elements just calculated:

Very similar to the corresponding tree-level amplitudes in QED

→ Expect similar, Coulomb-like, effective potential in the static limit

Constant depends on the color representation for the quark pair:

$$V_{q\bar{q}} = \begin{cases} -\frac{4}{3} \frac{\alpha_s}{r} & \text{singlet} \\ \frac{1}{6} \frac{\alpha_s}{r} & \text{octet} \end{cases} \quad \text{Attractive}$$
$$V_{qq} = \begin{cases} -\frac{2}{3} \frac{\alpha_s}{r} & \text{triplet} \\ \frac{1}{3} \frac{\alpha_s}{r} & \text{sextet} \end{cases} \quad \text{Attractive}$$

Expect maximal attraction in singlet

Color Factors - X

Baryons could be in any one of the **1,8,10** representations:

Why only the singlet is observed?

A hint of an explanation:

$$\mathbf{3} \otimes \mathbf{3} \otimes \mathbf{3} = (\mathbf{3} \otimes \mathbf{3}) \otimes \mathbf{3}$$

$$\mathbf{3} \otimes \mathbf{3} = \mathbf{6} \oplus \mathbf{3}^* \rightarrow (\mathbf{3} \otimes \mathbf{3}) \otimes \mathbf{3} = (\mathbf{6} \oplus \mathbf{3}^*) \otimes \mathbf{3}$$

$$\mathbf{6} \otimes \mathbf{3} = \mathbf{10} \oplus \mathbf{8}$$

$$\mathbf{3}^* \otimes \mathbf{3} = \mathbf{1} \oplus \mathbf{8}$$

1: each qq pair is a triplet \rightarrow attractive

8: qq pair can be triplets, or sextet \rightarrow attractive + repulsive

10: each qq pair is a sextet \rightarrow repulsive

So singlet is the state maximally attractive for 3 quarks

Does this explain the singlet-only mystery of bound states?

Running Coupling: QED - I

Consider the *one loop* modification to the photon propagator:

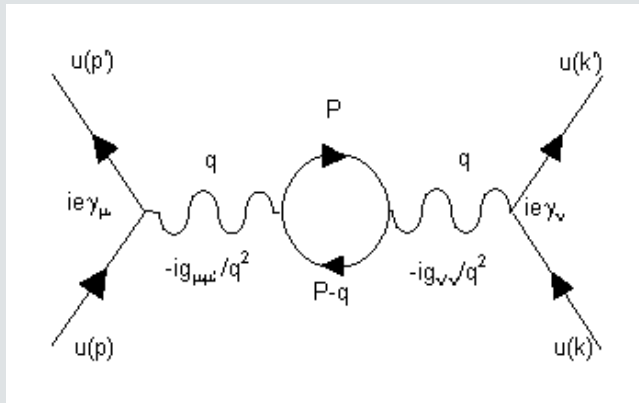

Includes a sum over P , the momentum circulating in the virtual loop. No obvious bounds on P .

$$M \propto [e\bar{u}(k')\gamma^\mu u(k)] \frac{g_{\mu\mu'}}{q^2} \frac{1}{(2\pi)^4} \int d^4P \frac{[e\bar{u}(P)\gamma^{\mu'}u(P-q)] [e\bar{u}(P-q)\gamma^{\nu'}u(P)]}{P^2 - m^2} \frac{g_{\nu\nu'}}{q^2} [e\bar{u}(p')\gamma^\nu u(p)]$$

Modified propagator:

$$\frac{g_{\mu\nu}}{q^2} \rightarrow \frac{g_{\mu\nu}}{q^2} (1 - I(q^2)), \quad I(q^2) = \frac{\alpha}{3\pi} \int \frac{dp^2}{p^2} - \frac{2\alpha}{\pi} \int_0^1 dx x(1-x) \ln \left[1 - \frac{q^2 x(1-x)}{m^2} \right]$$

Running Coupling: QED - II

Take the high q^2 approximation

$$-q^2 \gg m^2 \rightarrow \ln \left[1 - \frac{q^2 x(1-x)}{m^2} \right] \approx \ln \left[-\frac{q^2}{m^2} \right]$$

Provisional upper bound (cutoff) to make integral converging

$$I(q^2) \approx \frac{\alpha}{3\pi} \int_{m^2}^{M^2} \frac{dp^2}{p^2} - \frac{2\alpha}{\pi} \int_0^1 dx x(1-x) \ln \left[\frac{-q^2}{m^2} \right]$$

$$I(q^2) \approx \frac{\alpha}{3\pi} \ln \left(\frac{M^2}{m^2} \right) - \frac{2\alpha}{\pi} \frac{1}{6} \ln \left[\frac{-q^2}{m^2} \right] = \frac{\alpha}{3\pi} \left[\ln \left(\frac{M^2}{m^2} \right) - \ln \left[\frac{-q^2}{m^2} \right] \right] = \frac{\alpha}{3\pi} \ln \left(\frac{M^2}{-q^2} \right)$$

$$M \propto \alpha \left[\bar{u}(k') \gamma^\mu u(k) \right] \frac{g_{\mu\nu}}{q^2} \left[1 - \frac{\alpha}{3\pi} \ln \left(\frac{M^2}{-q^2} \right) \right] \left[\bar{u}(p') \gamma^\nu u(p) \right]$$

Cartoon translation:

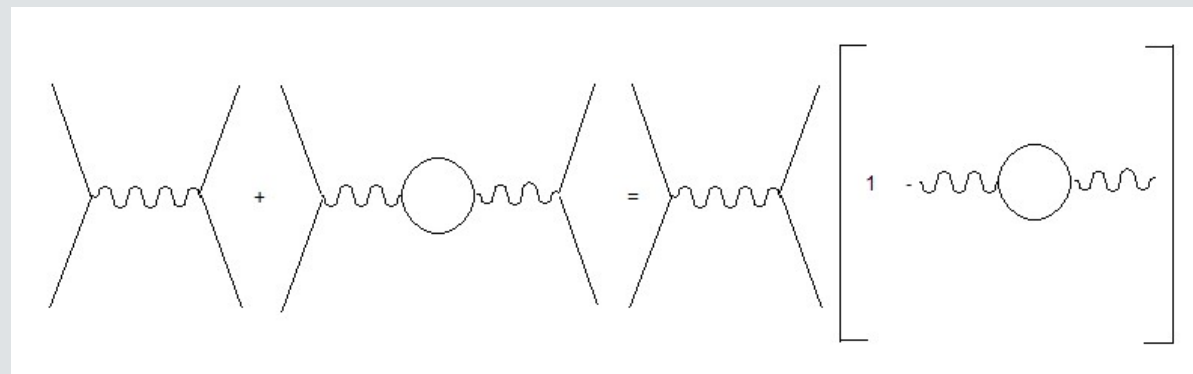

Running Coupling: QED - III

Extend to diagrams with $2, 3, \dots, n, \dots$ loops: Add up all contributes

Sum of a 'geometrical series': Converging ??

The diagram illustrates the summation of a geometric series for the photon propagator. On the left, the bare propagator is shown as a wavy line between two vertices. This is equated to a sum of diagrams enclosed in large square brackets. The first term inside the brackets is the bare propagator. The second term is the bare propagator plus a loop (a circle with a wavy line inside), enclosed in square brackets. This second term is then squared, indicating the start of a series. The final result is shown as the bare propagator multiplied by a fraction: the numerator is 1, and the denominator is 1 plus the loop diagram.

Experts say this is the only contribution to running α to the 'leading logs' approximation, which means neglecting the next levels of iteration

Running Coupling: QED - IV

$$M \propto [\bar{u}(k') \gamma^\mu u(k)] \frac{g_{\mu\nu}}{q^2} \left[\frac{\alpha}{1 + \alpha/3\pi \ln(M^2/-q^2)} \right] [\bar{u}(p') \gamma^\nu u(p)]$$

What is α ?

Coupling 'constant' we would get should we turn off all loops

Call it $\alpha_0 =$ 'Bare' coupling constant, not physical:

Loops cannot be turned off

Then obtain an effective coupling, not constant but running:

$$\alpha(q^2) = \frac{\alpha_0}{1 + \alpha_0/3\pi \ln(M^2/-q^2)}$$

α is q^2 , or distance, dependent!

Running Coupling: QED - V

Running α is still cutoff dependent, which of course is uncomfortable

But: Not a real problem.

Indeed:

$$Q^2 = -q^2 \rightarrow \alpha(Q^2) = \frac{\alpha_0}{1 + (\alpha_0/3\pi) \ln(M^2/Q^2)}$$

Take a particular energy scale: $Q^2 = \mu^2$

$$\rightarrow \alpha(\mu^2) = \frac{\alpha_0}{1 + (\alpha_0/3\pi) \ln(M^2/\mu^2)}$$

Usually choose $\mu^2=0$, i.e. take α at distance $\rightarrow \infty$

Quite natural in QED (but not compulsory)

Running Coupling: QED - VI

$$\ln\left(\frac{M^2}{Q^2}\right) = \ln\left(\frac{M^2}{Q^2} \frac{\mu^2}{\mu^2}\right) = \ln\left(\frac{M^2}{\mu^2}\right) + \ln\left(\frac{\mu^2}{Q^2}\right)$$

$$\rightarrow \alpha(Q^2) = \frac{\alpha_0}{1 + (\alpha_0/3\pi) [\ln(M^2/\mu^2) + \ln(\mu^2/Q^2)]}$$

$$\rightarrow \alpha(\mu^2) = \frac{\alpha_0}{1 + (\alpha_0/3\pi) [\ln(M^2/\mu^2) + \ln(\mu^2/\mu^2)]} = \frac{\alpha_0}{1 + (\alpha_0/3\pi) \ln(M^2/\mu^2)}$$

$$\rightarrow \frac{\alpha_0}{\alpha(\mu^2)} = 1 + (\alpha_0/3\pi) \ln(M^2/\mu^2)$$

$$\rightarrow \alpha(Q^2) = \frac{\alpha_0}{\alpha_0/\alpha(\mu^2) + \alpha_0/3\pi \ln(\mu^2/Q^2)} = \frac{\alpha(\mu^2)}{1 - [\alpha(\mu^2)/3\pi] \ln(Q^2/\mu^2)}$$

*Very interesting result: Running α depends on q^2 , through its own *measured* value at any chosen energy scale μ^2 .*

Cutoff has disappeared.

Running Coupling: QED - VII

Deep physics involved:

A ∞ number of diagrams can be formally replaced by a single, 1-photon diagram where the coupling 'constant' is running with q^2

Result valid to the 'leading log' approximation

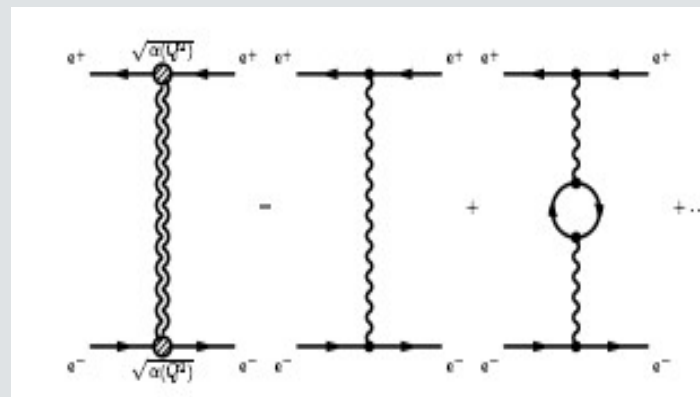

Running Coupling: QED - VIII

Virtual (loops) e^+e^- pairs

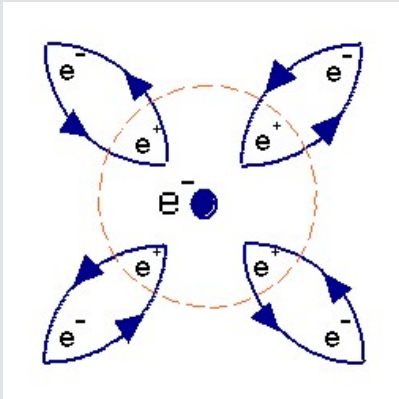

Effective shielding

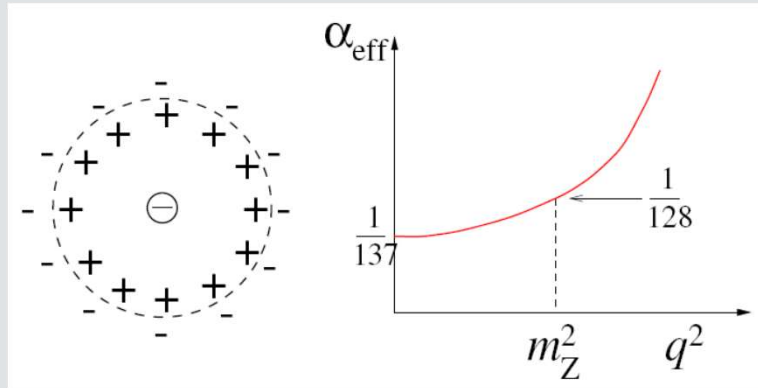

@TBA

Picture the QED perturbative vacuum as a sort of (virtual) dielectric medium:
Virtual photons and e^+e^- pairs continuously created/annihilated

Bare charge is shielded at large distance by the virtual pairs coming from loops.

The standard e charge is smaller than the bare charge

By probing the electron at smaller and smaller distance,
observe an *increasing* effective charge

Running α at LEP - I

Experimental method: Bhabha scattering

δ_γ, δ_Z s -channel contributions (small)

ε radiative corrections (known)

Use accurate, differential cross-section measurement to unfold $\alpha(t)$

[Total cross-section measurement would require a luminosity]

$$\frac{d\sigma}{dt} = \frac{d\sigma^0}{dt} \left(\frac{\alpha(t)}{\alpha_0} \right)^2 (1 + \varepsilon)(1 + \delta_\gamma) + \delta_Z,$$

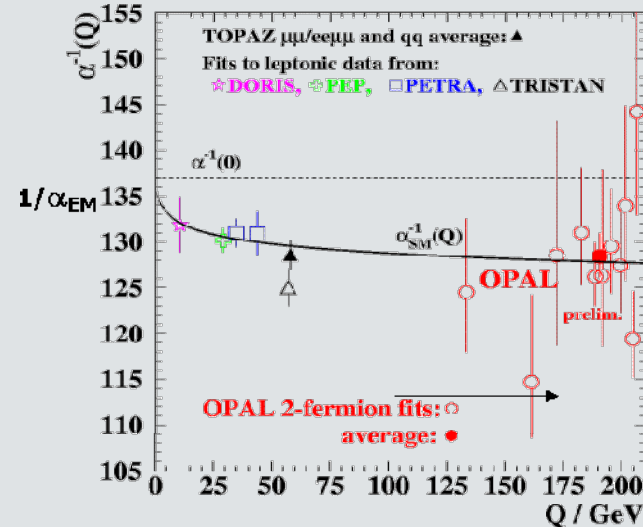
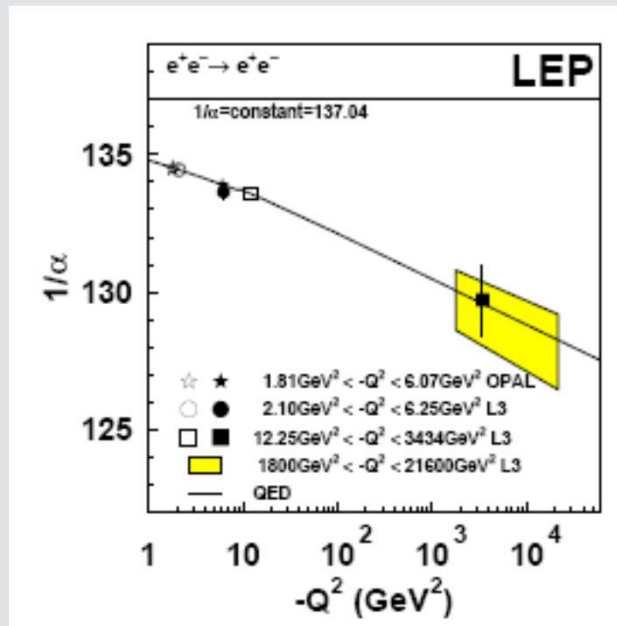

Running α at LEP - II

Just as an example, take L3 at LEP:
Relying on Bhabha scattering at small angle

$$\sigma = \frac{16\pi\alpha^2}{s} \left(\frac{1}{\theta_{min}^2} - \frac{1}{\theta_{max}^2} \right)$$

Calorimeter (Energy) + Silicon Tracker (Angle + Acceptance)

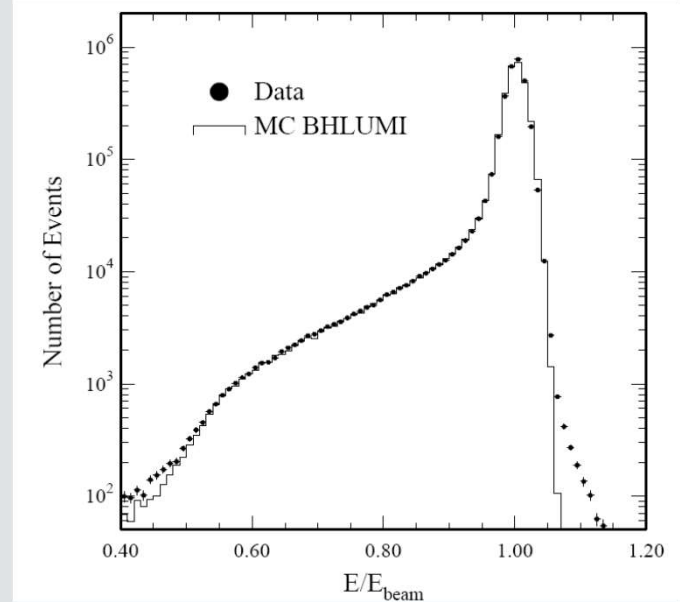
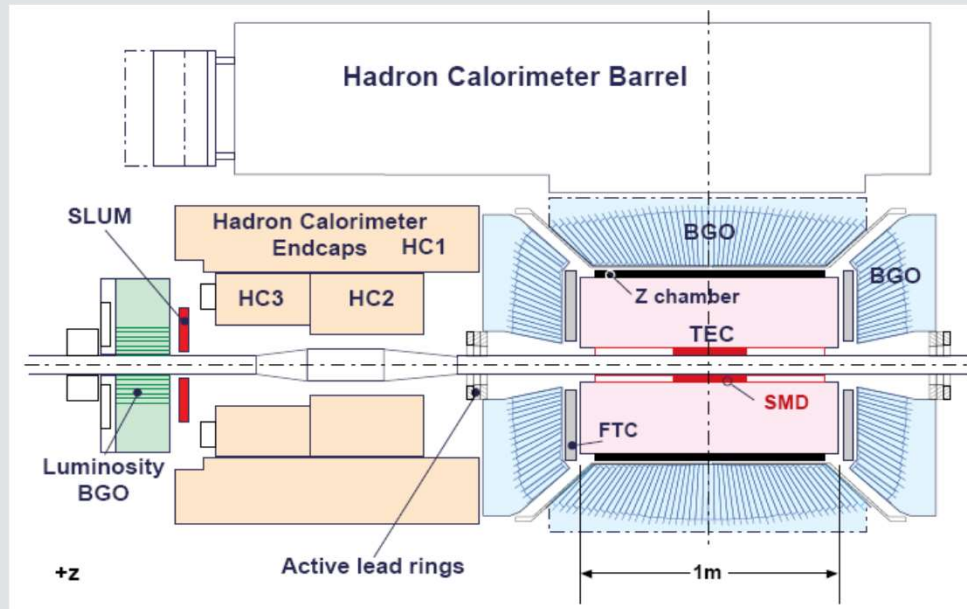

Running Coupling: QCD - I

Repeat all the steps: Loops etc

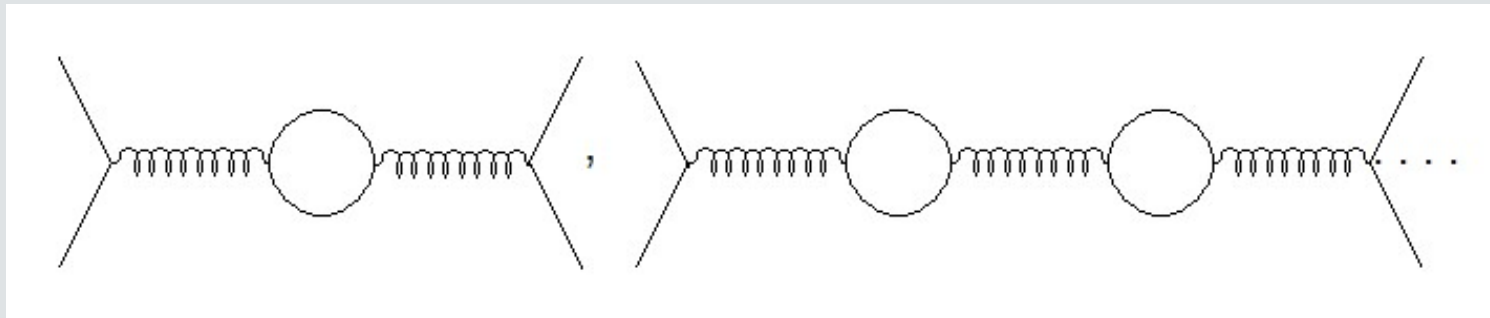

Except this time one has more loops: Gluons

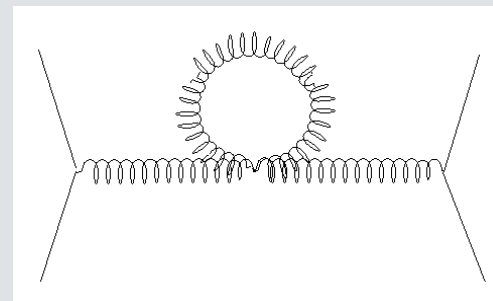
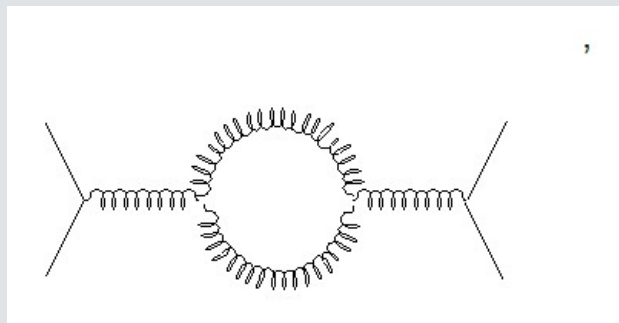

Running Coupling: QCD - II

Turns out gluon loops yield *anti*-shielding effect
With 8 gluons and 6 quark flavors, gluons win

$$\alpha_s(|q^2|) = \frac{\alpha_s(\mu^2)}{1 + (\alpha_s(\mu^2)/12\pi)(33 - 2n_{flavor}) \ln(|q^2|/\mu^2)}$$

Running coupling *decreases* with increasing q^2 (or at smaller distance)
This is known as *asymptotic freedom*:

Large q^2 processes feature small coupling \rightarrow Perturbative!

Most important consequence:

The fundamental hypothesis behind the successful parton model is finally understood and justified

Running Coupling: QCD - III

α, α_s vs. Energy Scale: Asymptotic Freedom, Infrared Slavery, QED

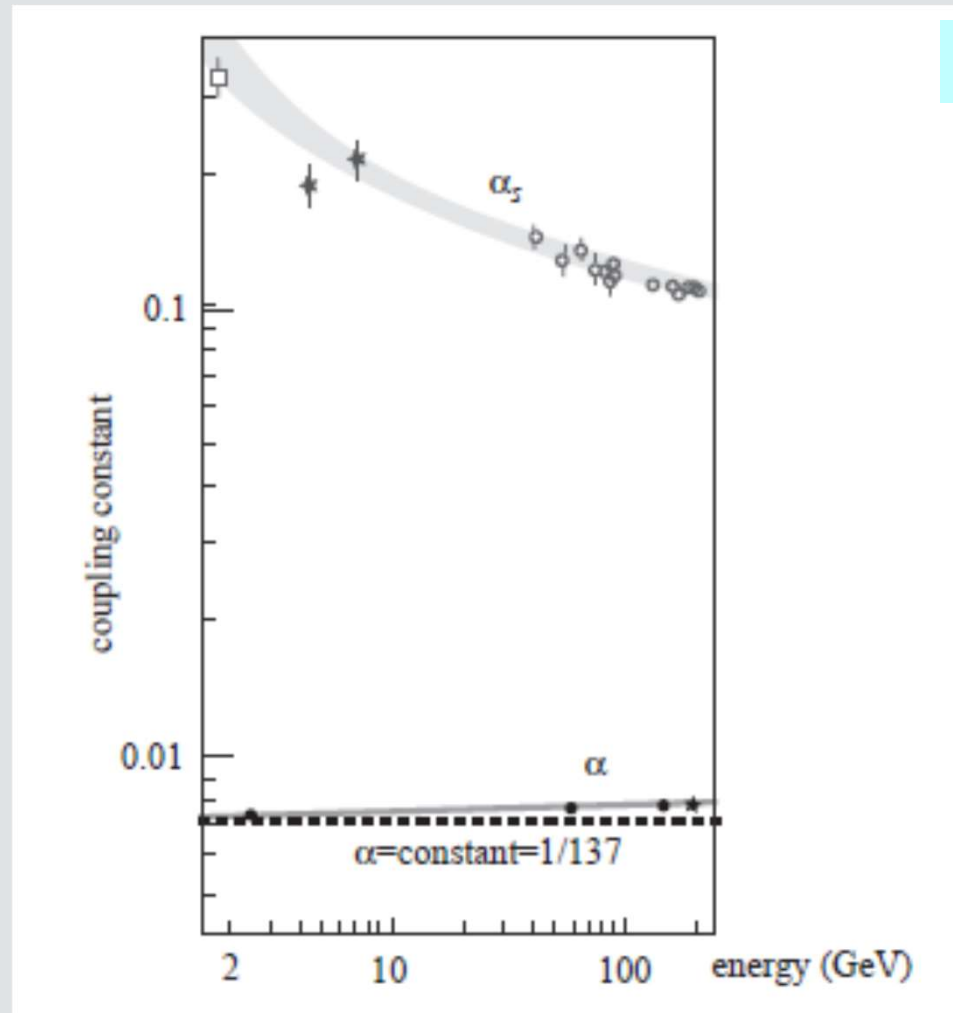

Running Coupling: QCD - IV

Rather than making reference to a specific value of α_s

$$\alpha_s(|q^2|) = \frac{\alpha_s(\mu^2)}{1 + (\alpha_s(\mu^2)/12\pi)(33 - 2n_{flavor}) \ln(|q^2|/\mu^2)}$$

define a new constant

$$\ln \Lambda^2 = \ln \mu^2 - \frac{12\pi}{(33 - 2n_{flavor})\alpha_s(\mu^2)} \rightarrow \Lambda^2 = \mu^2 e^{-\frac{12\pi}{(33 - 2n_{flavor})\alpha_s(\mu^2)}}$$

$$\rightarrow \alpha_s(|q^2|) \simeq \frac{12\pi}{(33 - 2n_{flavor}) \ln(|q^2|/\Lambda^2)} = \frac{12\pi}{21 \ln(|q^2|/\Lambda^2)}, \quad |q^2| \gg \Lambda^2$$

Λ = Renormalization scale \rightarrow Fixes α_s at all q^2

$\Lambda \approx 200 \text{ MeV}$ yields the correct α_s at $\mu^2 = M_{Z^0}^2$

Funny behavior, known as 'Dimensional Transmutation':

From an adimensional constant to a dimensional one $\alpha_s \rightarrow \Lambda$

Running Coupling: QCD - V

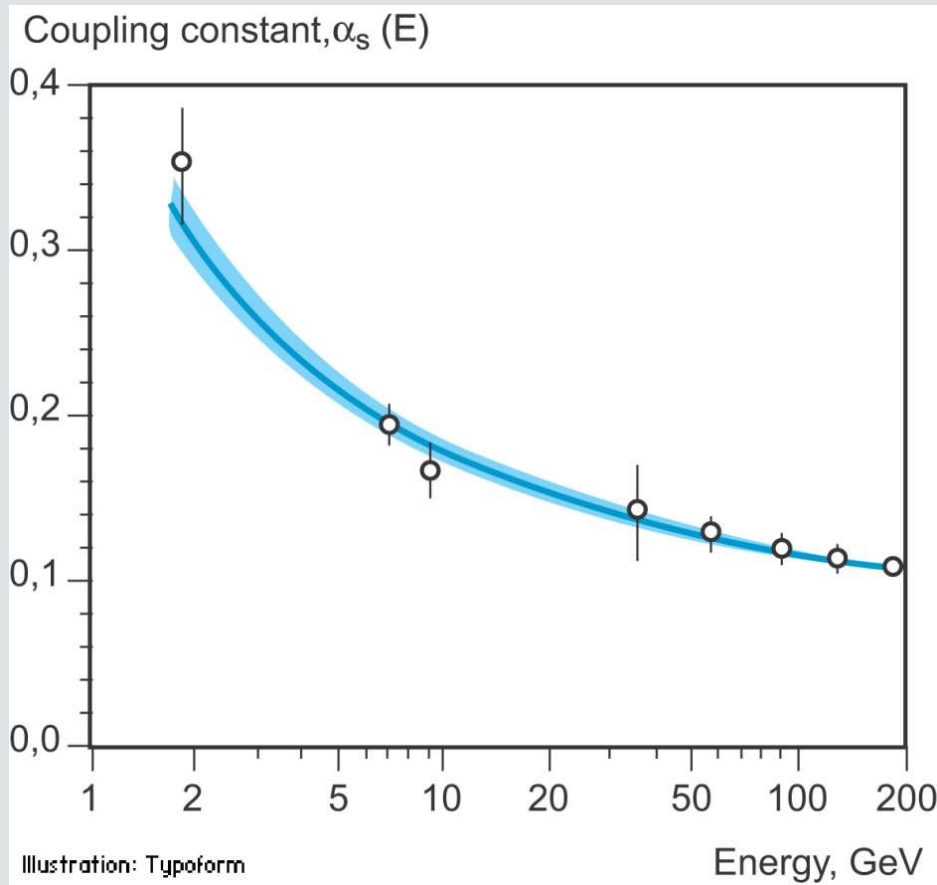

Sources:

Jets

DIS

Quarkonium

Annihilation: Muons vs Quarks

Electron-Positron annihilation:

Electroweak process

Low energy ($E_{CM} \ll M_{Z^0}$): Mostly electromagnetic

High energy ($E_{CM} \sim M_{Z^0}$): Mostly neutral current

Final state: *Fermion / Antifermion* pair

Muon vs quark pairs

Best observed at e^+e^- colliders

Annihilation Cross-Section - I

Apply crossing symmetry to electron-muon scattering, take pure e.m. amplitude at tree level

$$e^- + \mu^- \rightarrow e^- + \mu^- \quad \text{A: Scattering}$$

$$e^- + \left[e^- \right]_{\text{crossed}} \rightarrow \left[\mu^- \right]_{\text{crossed}} + \mu^- \equiv e^- + e^+ \rightarrow \mu^+ + \mu^- \quad \text{B: Annihilation}$$

Amplitude for scattering:

$$T_{fi}(s, s', r, r') = (-e) \bar{u}_{(\mu)}(p_2', s') \gamma^\mu u_{(\mu)}(p_2, s) \frac{-ig_{\mu\nu}}{q^2} (-e) \bar{u}_{(e)}(p_1', r') \gamma^\nu u_{(e)}(p_1, r)$$

$$q = p_1 - p_1' \rightarrow q^2 = (p_1 - p_1')^2 = p_1^2 + p_1'^2 - 2p_1 \cdot p_1'$$

$$q^2 = 2m_e^2 - 2(E_1 E_1' - \mathbf{p}_1 \cdot \mathbf{p}_1') \underset{E \gg m}{\simeq} -2(E_1 E_1' - \mathbf{p}_1 \cdot \mathbf{p}_1') < 0 \quad q=4\text{-momentum transfer}$$

Amplitude for annihilation:

$$T_{fi}(s, s', r, r') = (-e) \bar{u}_{(\mu)}(p_2', s') \gamma^\mu v_{(\mu)}(p_1', r') \frac{-ig_{\mu\nu}}{q^2} (-e) \bar{v}_{(e)}(p_1, s) \gamma^\nu u_{(e)}(p_2, r)$$

$$q = p_1 + p_2 \rightarrow q^2 = (p_1 + p_2)^2 = p_1^2 + p_2^2 + 2p_1 \cdot p_2$$

$$q^2 = 2m_e^2 + 2(E_1 E_2 - \mathbf{p}_1 \cdot \mathbf{p}_2) \underset{E \gg m}{\simeq} 2(E_1 E_2 - \mathbf{p}_1 \cdot \mathbf{p}_2) > 0 \quad q=\text{total 4-momentum}$$

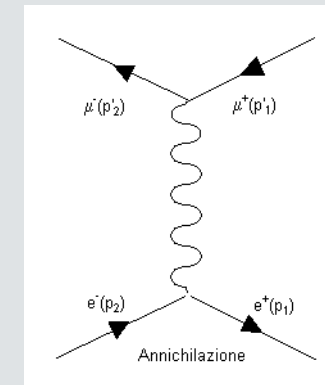
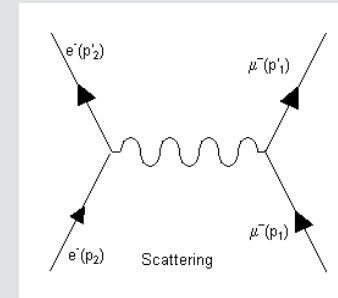

Annihilation Cross-Section - II

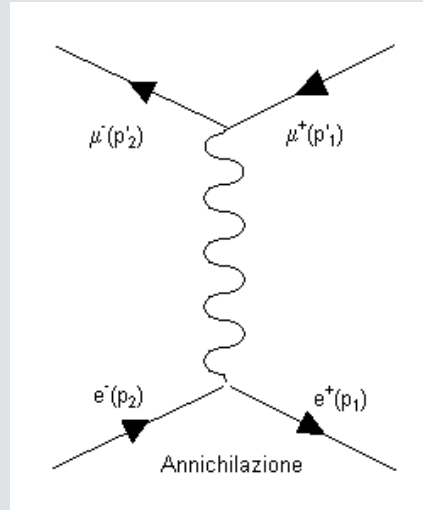

$$T_{fi} = \bar{v}(p_1, s') \gamma^\mu u(p_2, s) \frac{e^2}{q^2} \bar{u}(p_2', r) \gamma_\mu v(p_1', r')$$

$$|T_{fi}|^2 = \frac{e^4}{q^4} \left[\bar{v}(p_1, s') \gamma^\mu u(p_2, s) \bar{u}(p_2', s) \gamma^\nu v(p_1', s') \right] \left[\bar{v}(p_1, r) \gamma_\mu u(p_2, r') \bar{u}(p_2', r') \gamma_\nu v(p_1', r) \right]$$

Annihilation Cross-Section - III

$$|T_{fi}|^2 = \frac{e^4}{q^4} [\bar{v}(p_1, s') \gamma^\mu u(p_2, s) \bar{u}(p_2', s) \gamma^\nu v(p_1', s')] [\bar{v}(p_1, r) \gamma_\mu u(p_2, r') \bar{u}(p_2', r') \gamma_\nu v(p_1', r)]$$

$$\langle |T_{fi}|^2 \rangle = \frac{1}{4} \sum_{s, s', r, r'} |T_{fi}|^2 = \frac{e^4}{4q^4} \text{Tr}[(\not{p}_1 - m) \gamma^\mu (\not{p}_2 + m) \gamma^\nu] \text{Tr}[(\not{p}_2' + M) \gamma_\mu (\not{p}_1' - M) \gamma_\nu]$$

$$\text{Tr}[(\not{p}_1 - m) \gamma^\mu (\not{p}_2 + m) \gamma^\nu] = 4 [p_1^\mu p_2^\nu + p_1^\nu p_2^\mu - g^{\mu\nu} (p_2 \cdot p_1 + m^2)]$$

$$\text{Tr}[(\not{p}_2' + M) \gamma_\mu (\not{p}_1' - M) \gamma_\nu] = 4 [p_1'^\mu p_2'^\nu + p_1'^\nu p_2'^\mu - g^{\mu\nu} (p_2' \cdot p_1' + M^2)]$$

$$\rightarrow \langle |T_{fi}|^2 \rangle = \frac{8e^4}{q^4} [(p_1 \cdot p_1')(p_2 \cdot p_2') + (p_1 \cdot p_2')(p_2 \cdot p_1') + M^2 (p_1 \cdot p_2)] \quad m \approx 0$$

$$CM : \begin{cases} p_1 = (E \ 0 \ 0 \ E), p_2 = (E \ 0 \ 0 \ -E) \\ |\mathbf{p}'| = |\mathbf{p}_1'| = |\mathbf{p}_2'| = \sqrt{E^2 - M^2} \end{cases}$$

$$p_1' = (E \ |\mathbf{p}'| \sin \theta \ 0 \ |\mathbf{p}'| \cos \theta)$$

$$p_2' = (E \ -|\mathbf{p}'| \sin \theta \ 0 \ -|\mathbf{p}'| \cos \theta)$$

$$\rightarrow \langle |T_{fi}|^2 \rangle = e^4 \left[1 + \frac{M^2}{E^2} + \left(1 - \frac{M^2}{E^2} \right) \cos^2 \theta \right]$$

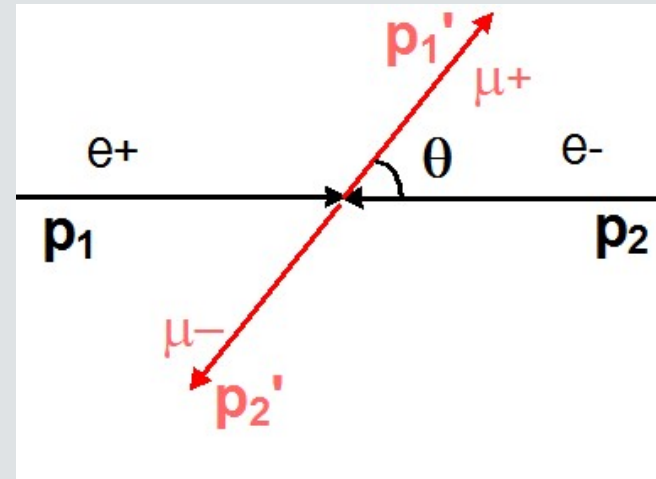

Annihilation Cross-Section - IV

$$\left. \frac{d\sigma}{d\Omega} \right|_{CM} = \frac{\alpha^2}{4s} \sqrt{1 - \frac{M^2}{E^2}} \left[1 + \frac{M^2}{E^2} + \left(1 - \frac{M^2}{E^2} \right) \cos^2 \theta \right]$$

$$\rightarrow \left. \frac{d\sigma}{d\Omega} \right|_{CM} \approx \frac{\alpha^2}{4s} (1 + \cos^2 \theta), \quad E \gg M$$

$$\sigma = \int_{\Omega} \left. \frac{d\sigma}{d\Omega} \right|_{CM} d\Omega = \frac{4\pi\alpha^2}{3s} \sqrt{1 - \frac{M^2}{E^2}} \left(1 + \frac{1}{2} \frac{M^2}{E^2} \right)$$

$$\gamma = \frac{E}{M} = \frac{1}{\sqrt{1 - \beta^2}}$$

$$\rightarrow \sigma = \frac{4\pi\alpha^2}{3s} \underbrace{\sqrt{\frac{\gamma^2 - 1}{\gamma^2}}}_{\beta} \left(\frac{1 + 2\gamma^2}{2\gamma^2} \right) = \frac{4\pi\alpha^2}{3s} \beta \left(\frac{1}{2\gamma^2} + 1 \right) = \frac{4\pi\alpha^2}{3s} \beta \left(\frac{3 - \beta^2}{2} \right)$$

$$\rightarrow \sigma \approx \frac{4\pi\alpha^2}{3s} = \frac{87}{s[\text{GeV}^2]} \text{nb}, \quad E \gg M$$

Annihilation Cross-Section - V

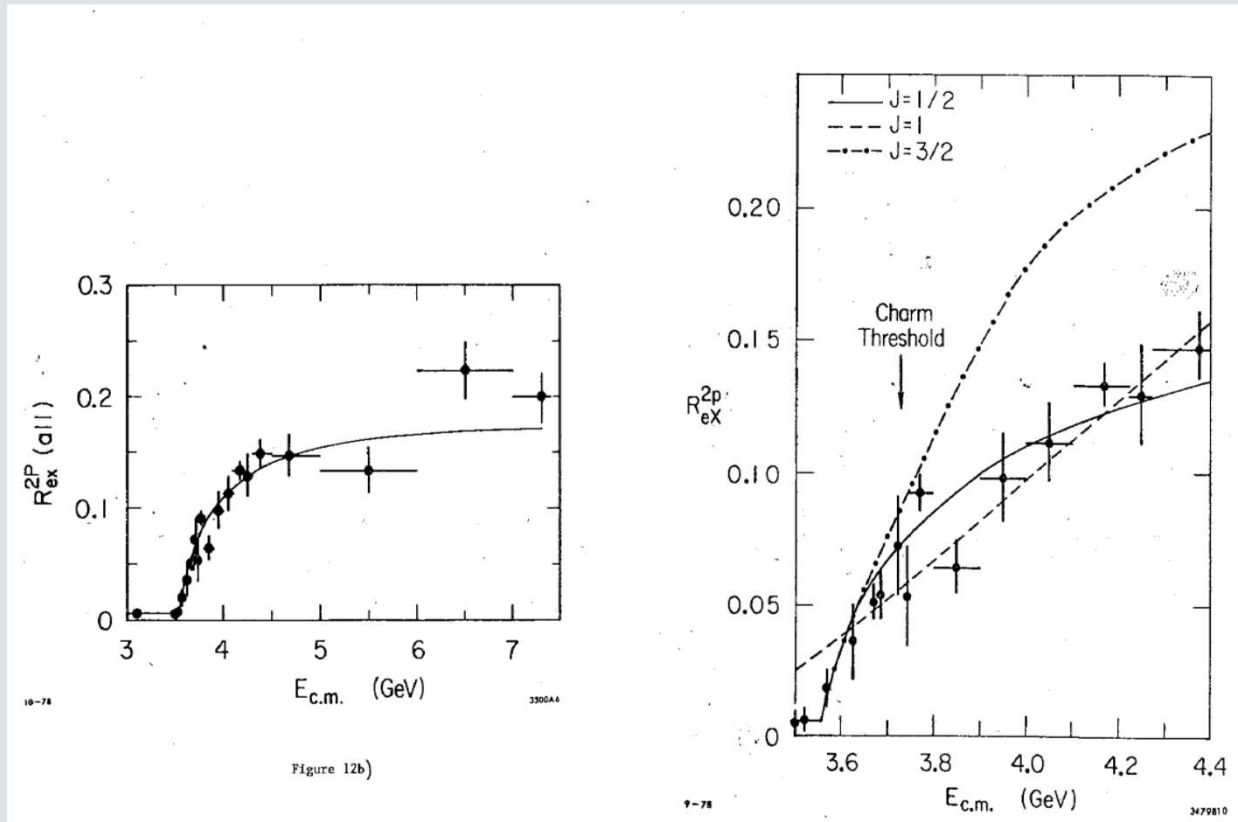

τ lepton discovery, mass & spin determination:

$$R_{eX}^{2p} \simeq \frac{\sigma(\tau^+\tau^-)}{\sigma(\mu^+\mu^-)} \simeq \sqrt{1 - \frac{M_\tau^2}{E^2}} \left(1 + \frac{1}{2} \frac{M_\tau^2}{E^2} \right), M_\mu \approx 0$$

Annihilation Cross-Section - VI

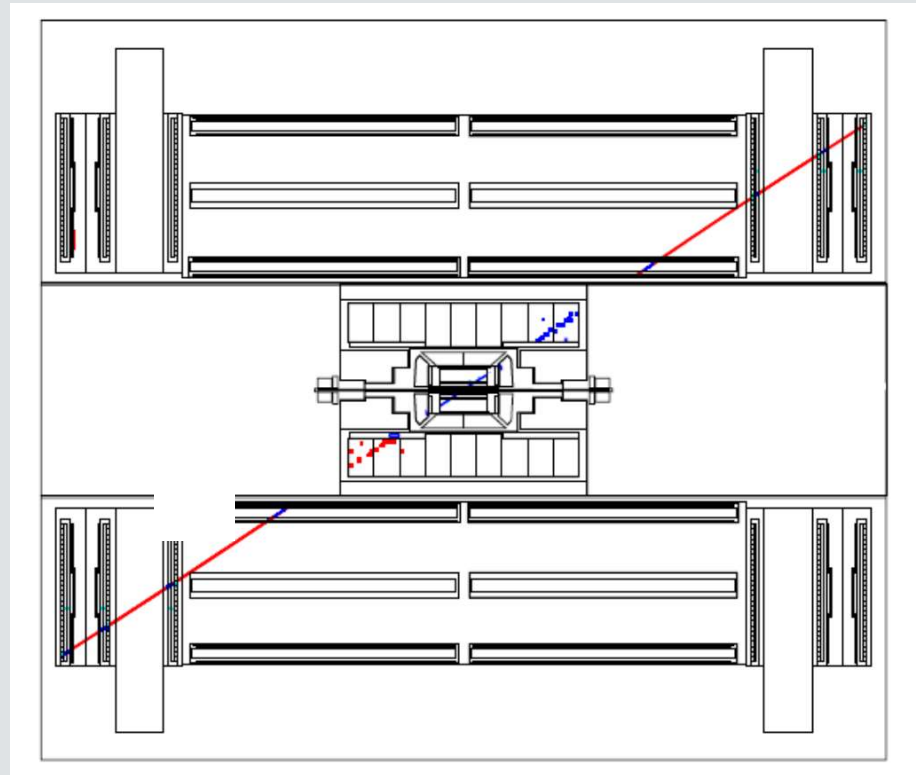

$\mu^+ \mu^-$ event: L3 detector at LEP

Annihilation Cross-Section - VII

Total cross-section vs s : Low energy

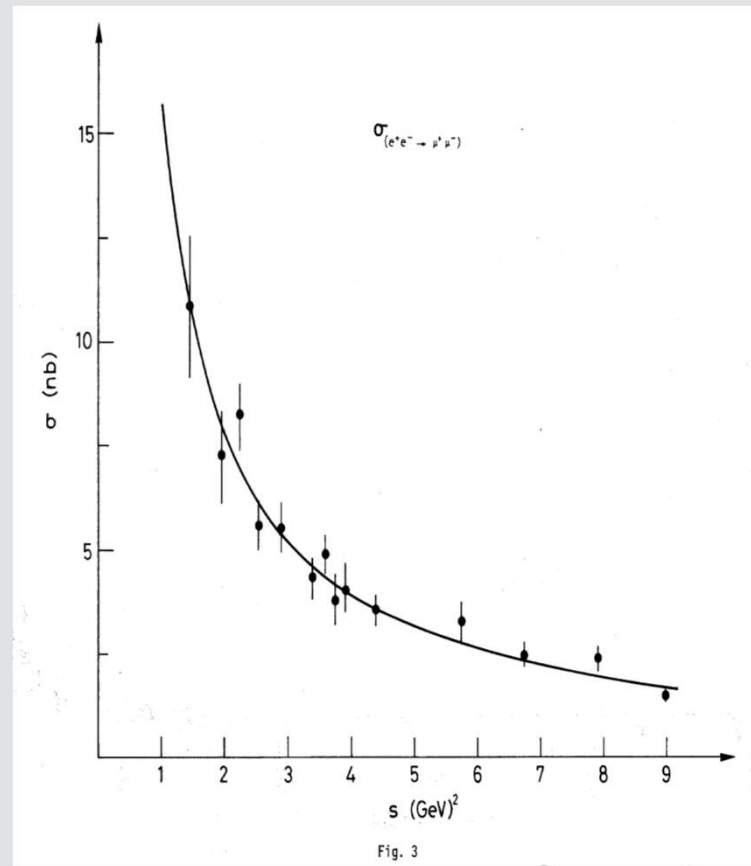

ADONE ('70s)

Annihilation Cross-Section - VIII

Total cross-section vs s : Higher energy

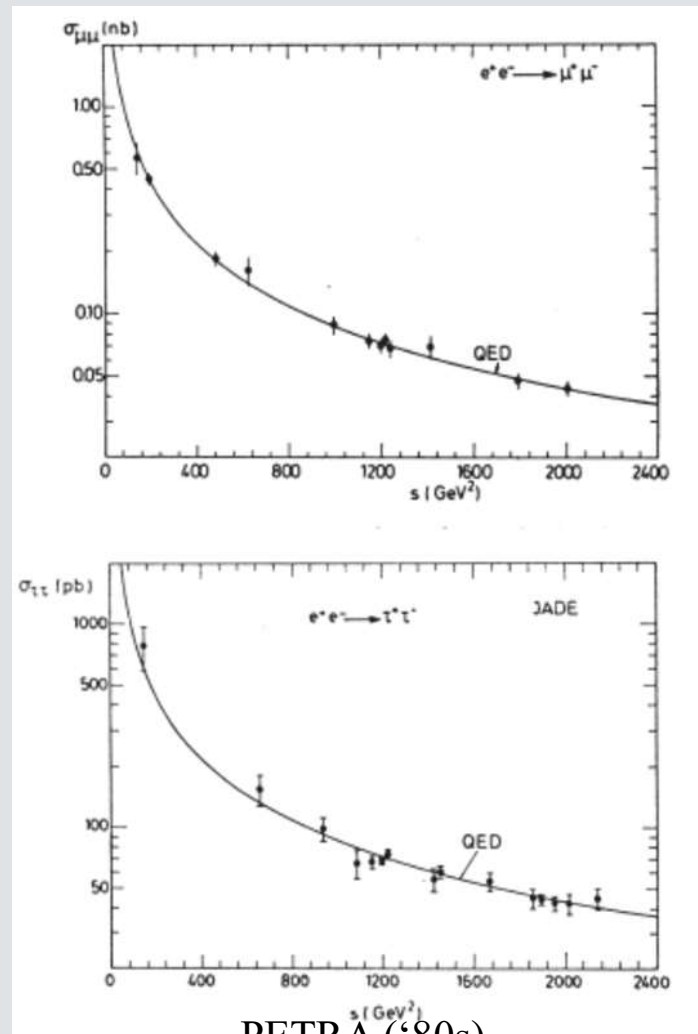

PETRA ('80s)

Annihilation Cross-Section - IX

Angular distribution: Low energy
1-photon, forward/backward symmetric

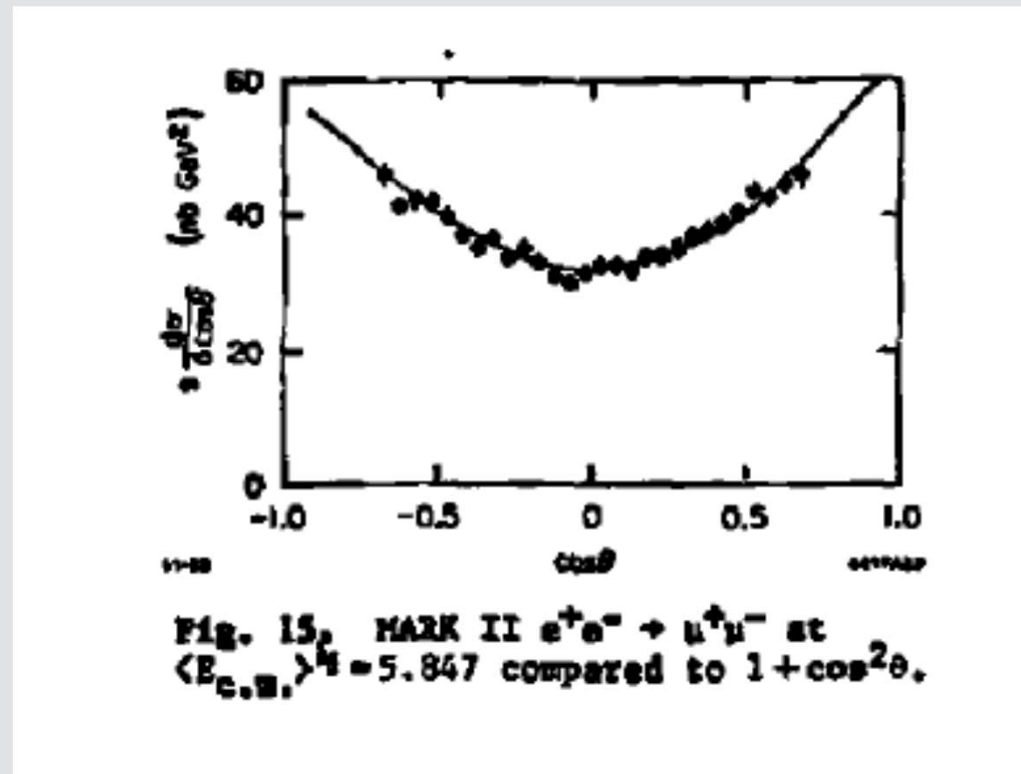

SPEAR ('70s)

Annihilation Cross-Section - X

Angular distribution: Higher energy:

Some contribution from Z^0 , forward/backward asymmetric

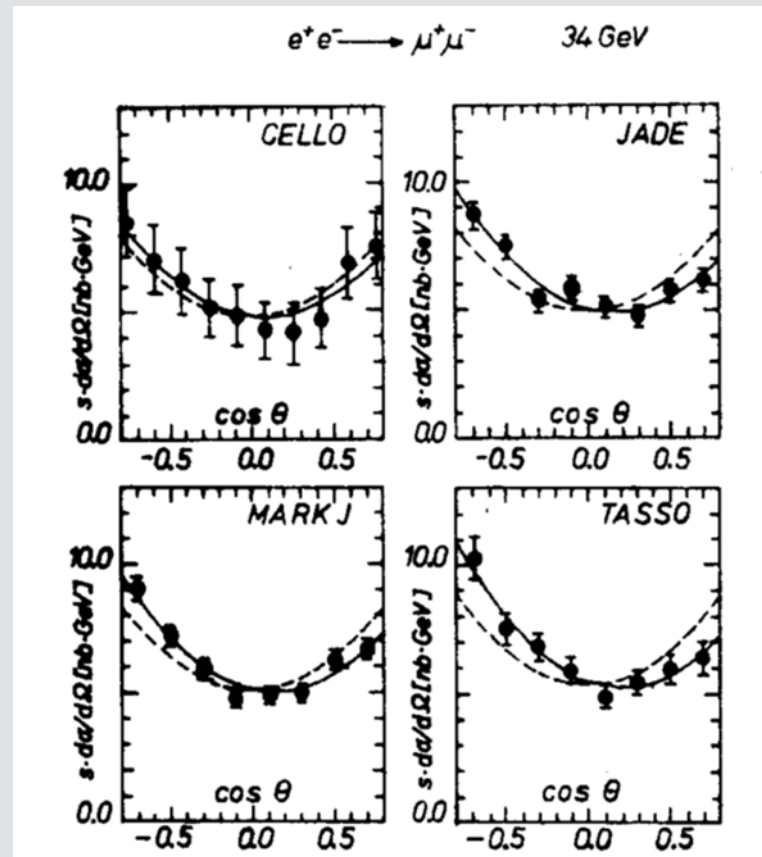

PETRA ('80s)

Annihilation Cross-Section - XI

Forward/Backward asymmetry: Important subject

Effective tool for precision tests of SM

May probe physics BSM

Interesting point:

Tiny asymmetry expected from pure QED

Coming from diagrams with >1 photon

Dominated by interference terms

between amplitudes (a) and (b)-(g):

Opposite charge parity

Recent surge of interest from large asymmetry

found at Tevatron in $t \bar{t}$ production by 1 and 2 gluons:

Similar physics, data not fully understood

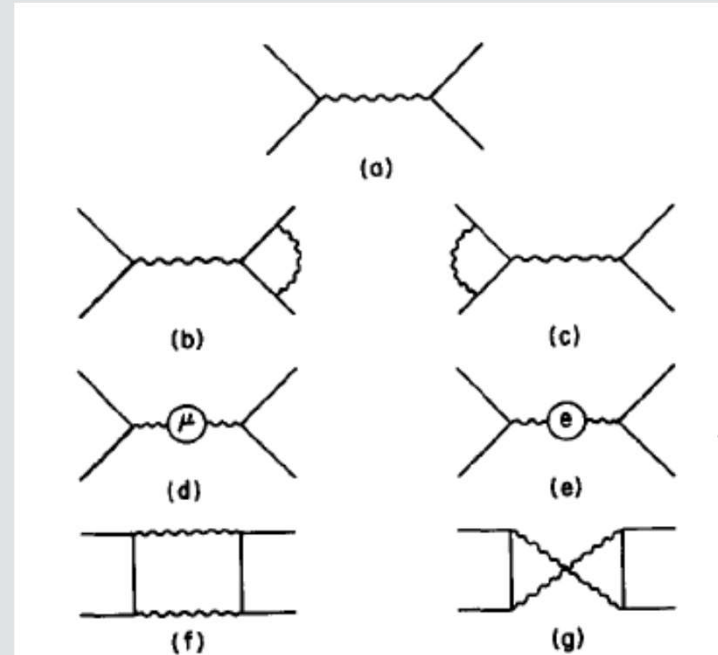

Perturbative QCD

Asymptotic freedom:

Allowing safe, accurate predictions for high Q^2 , primary subprocess

Radiative corrections under control, albeit after some special care in fixing infinities

Renormalization of gauge theories: Highly technical

Infrared slavery:

Forbidding any detailed prediction of hadronization

Non-perturbative parton evolution bound to rely on simulation

Ideal test bed:

Electron-Positron colliders

Observables:

Cross sections

Event shapes

Jets

PQCD: e^+e^- Collisions - I

e^+e^- annihilation into hadrons:

At the parton level = Crossed Deep Inelastic Scattering

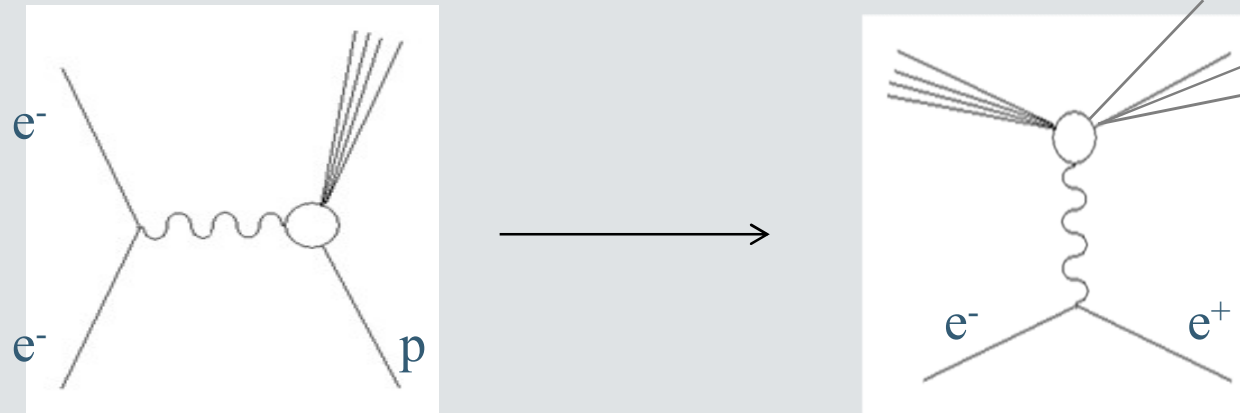

Understood as annihilation into a $q\bar{q}$ pair, followed by quark fragmentation into hadrons

Tree level process, dominating at high Q^2

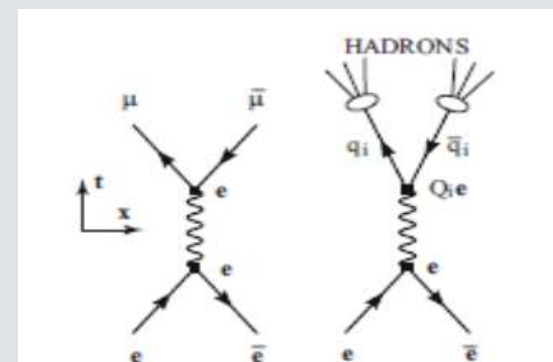

PQCD: e^+e^- Collisions - II

By ignoring *quark fragmentation* details

$$e^+ + e^- \rightarrow q + \bar{q} \rightarrow \text{hadrons}$$

$$\frac{d\sigma}{d\Omega} = \frac{3\alpha^2}{4s} (1 + \cos^2 \theta) \sum_{\text{flavor}} e_{\text{flavor}}^2$$

$$\rightarrow \sigma(s) = \frac{4\pi\alpha^2}{s} \sum_{\text{flavor}} e_{\text{flavor}}^2$$

Picture of quark fragmentation

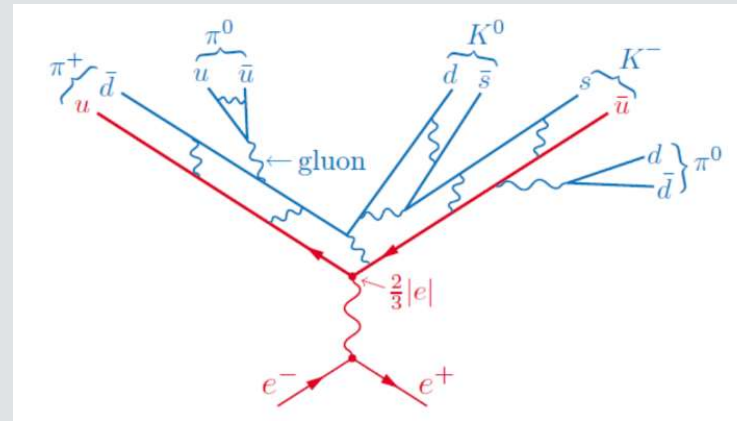

Due to color confinement, quark/antiquark unobservable as free particles

Expect hadron debris from quark fragmentation

Hadrons: Trend towards grouping into narrow pencils of particles

\rightarrow *Jets*

Naive prediction: 2 jets

At high energy, expect hadronic annihilation events to be *non-spherical*

PQCD: e^+e^- Collisions - III

Total hadronic cross section \leftrightarrow R Ratio

Reminder:

Time scale of hard interaction

$$T \sim \frac{1}{Q} = \frac{1}{\sqrt{s}} \sim \frac{1}{\text{Many GeV}} \rightarrow \text{Very small}$$

Time scale of soft hadronization

$$\tau \sim \frac{1}{\Lambda} \sim \frac{1}{1 \text{ GeV}} \rightarrow \text{Large}$$

\rightarrow Perturbative cross section OK

Expect at 30-40 GeV:

$$R = \frac{\sigma_{q\bar{q}}}{\sigma_{\mu\mu}} = 3 \sum_{i=u,d,s,c,b} Q_i^2 = \frac{11}{3} \approx 3.67 (+ 0.05 \text{ coming from } Z^0)$$

Measure :

$$R \approx 3.9$$

\rightarrow QCD Correction required

PQCD: e^+e^- Collisions - IV

QCD corrections Next to Leading Order (NLO):

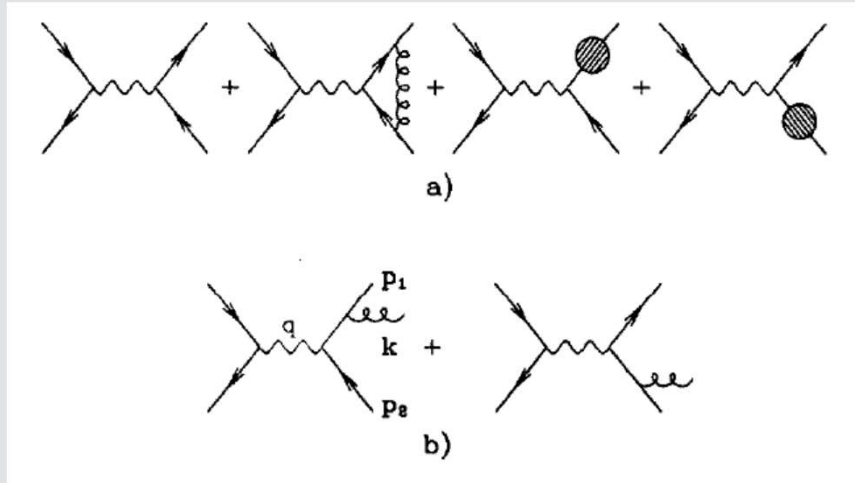

Virtual gluons

Real gluons

Real gluons: 3 particles in the final state

Some kinematics:

$$x_1 = \frac{2E_1}{\sqrt{s}}, x_2 = \frac{2E_2}{\sqrt{s}}$$

$$\rightarrow 0 \leq x_1, x_2 \leq 1, x_1 + x_2 \geq 1$$

$$x_3 = \frac{2E_g}{\sqrt{s}} = 2 - x_1 - x_2$$

PQCD: e^+e^- Collisions - V

Observe:

Plane (2D) event

Within the event plane: 2 degrees of freedom

Differential cross section:

$$\frac{1}{\sigma} \frac{d^2\sigma}{dx_1 dx_2} = \frac{2\alpha_s}{3\pi} \frac{x_1^2 + x_2^2}{(1-x_1)(1-x_2)}$$

Basic remark:

$$x_1, x_2 \rightarrow 1 \quad \rightarrow \quad \sigma \rightarrow \infty$$

Also true to higher perturbative orders

\rightarrow 2 jets dominant over everything else

PQCD: e^+e^- Collisions - VI

Total hadronic cross section:

$$\sigma^{q\bar{q}g} = \sigma_0 3 \sum_q Q_q^2 \int \frac{d^2\sigma}{dx_1 dx_2} dx_1 dx_2 = \sigma_0 3 \sum_q Q_q^2 \int \frac{2\alpha_s}{3\pi} \frac{x_1^2 + x_2^2}{(1-x_1)(1-x_2)} dx_1 dx_2$$

In order to regularize diverging integrals: Funny and smart idea
Shift to $4-2\varepsilon$ space-time dimensions, make them nicely converging..

Diagrams with real gluons:

$$\sigma^{q\bar{q}g} = \sigma_0 3 \sum_q Q_q^2 \frac{2\alpha_s}{3\pi} H(\varepsilon) \left[\frac{2}{\varepsilon^2} - \frac{3}{\varepsilon} + \frac{19}{2} + O(\varepsilon) \right]$$

Diagrams with virtual gluons:

$$\sigma^{q\bar{q}g} = \sigma_0 3 \sum_q Q_q^2 \frac{2\alpha_s}{3\pi} H(\varepsilon) \left[-\frac{2}{\varepsilon^2} + \frac{3}{\varepsilon} - 8 + O(\varepsilon) \right]$$

Adding everything up, and reverting to 4D:

$$R \xrightarrow{\varepsilon \rightarrow 0} 3 \sum_q Q_q^2 \left\{ 1 + \frac{\alpha_s}{\pi} + O(\alpha_s^2) \right\} \simeq 3 \cdot \frac{11}{9} \left(1 + \frac{0.14}{3.14} \right) = 3.83$$

$$R + R_{Z^0} \simeq 3.83 + 0.05 = 3.88 \quad !!!$$

PQCD: e^+e^- Collisions - VII

@TBA

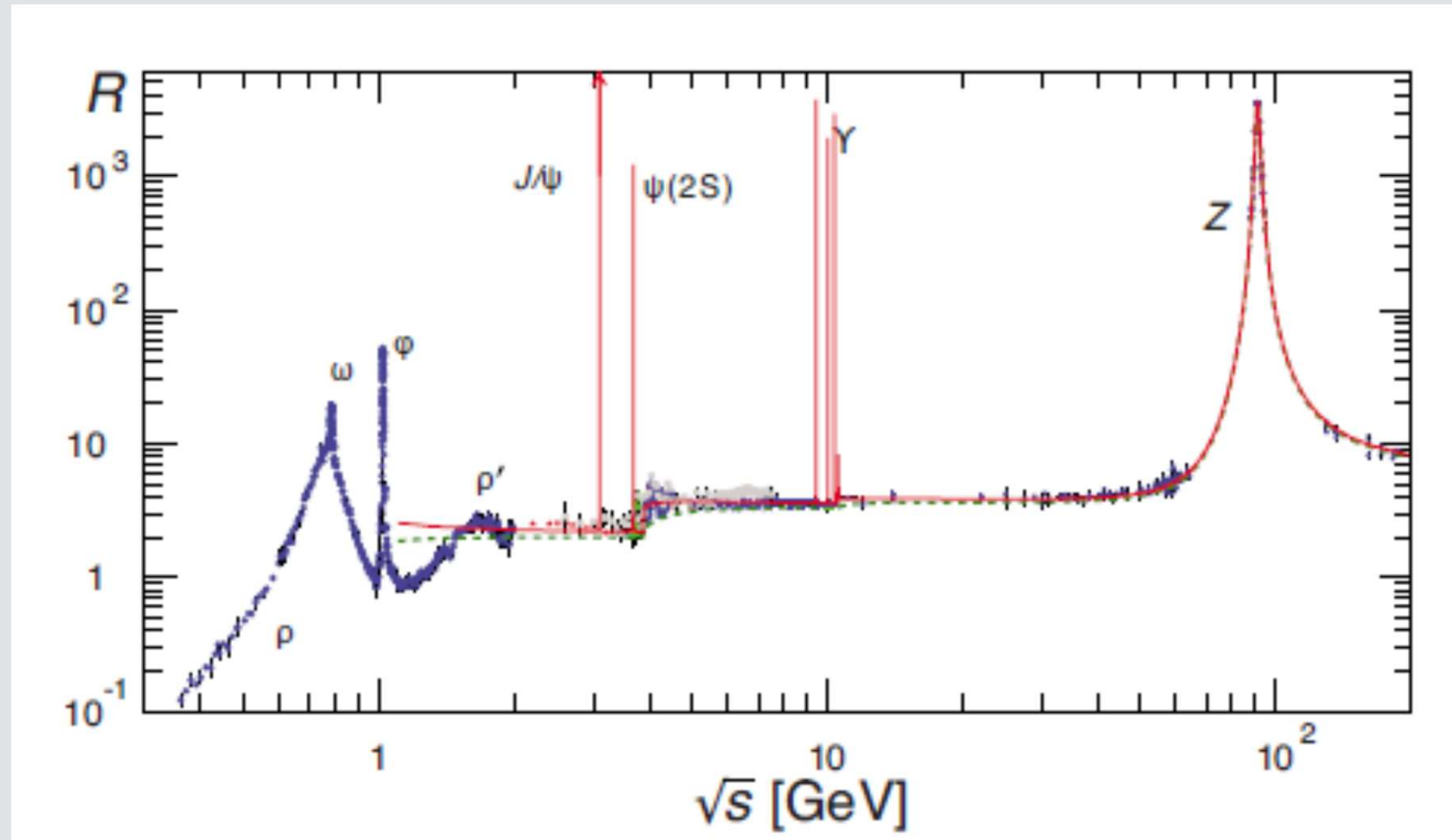

Fall 2020

Ezio Menichetti - Università di Torino

PQCD: e^+e^- Collisions - VIII

For 2 jets events

$$\left. \begin{aligned} \frac{d\sigma}{d\Omega} &\propto 1 + \cos^2 \theta \quad \text{quark spin} = 1/2 \\ \frac{d\sigma}{d\Omega} &\propto 1 - \cos^2 \theta \quad \text{quark spin} = 0 \end{aligned} \right\} \equiv 1 + \alpha \cos^2 \theta$$

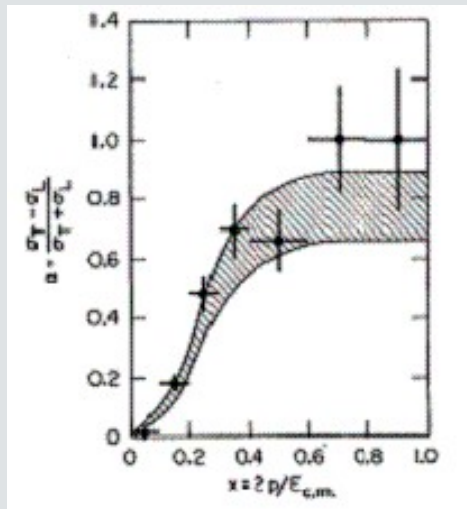

Mark I (SPEAR)
 $E = \text{few GeV}$

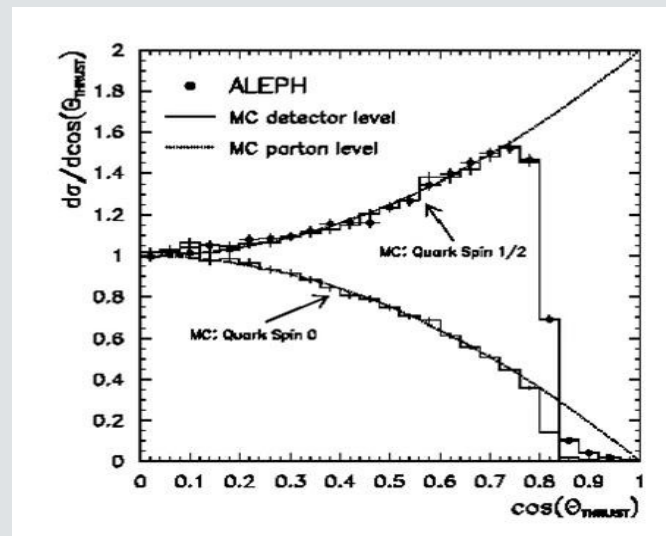

ALEPH (LEP)
 $E = 90 \text{ GeV}$

@TBA

PQCD: Event Shapes - I

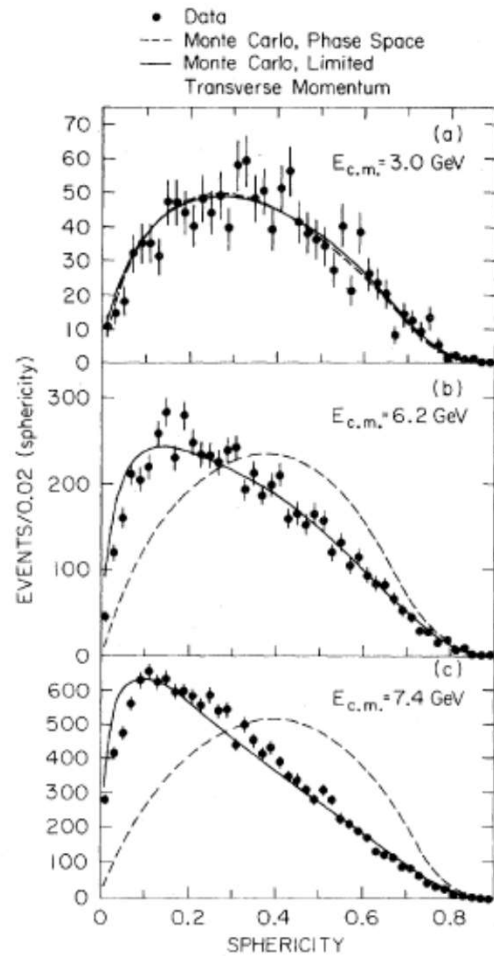

@TBA

Define *sphericity* of events:

$$S = \min \frac{3 \sum_i p_{\perp i}^2}{2 \sum_i p_i^2} \rightarrow \begin{cases} 0 & \text{2-jets} \\ 1 & \text{spherical} \end{cases}$$

min : Choose axes which minimize S (\leftarrow *Iterative*)

PQCD: Event Shapes - II

Interesting observable: *Thrust*

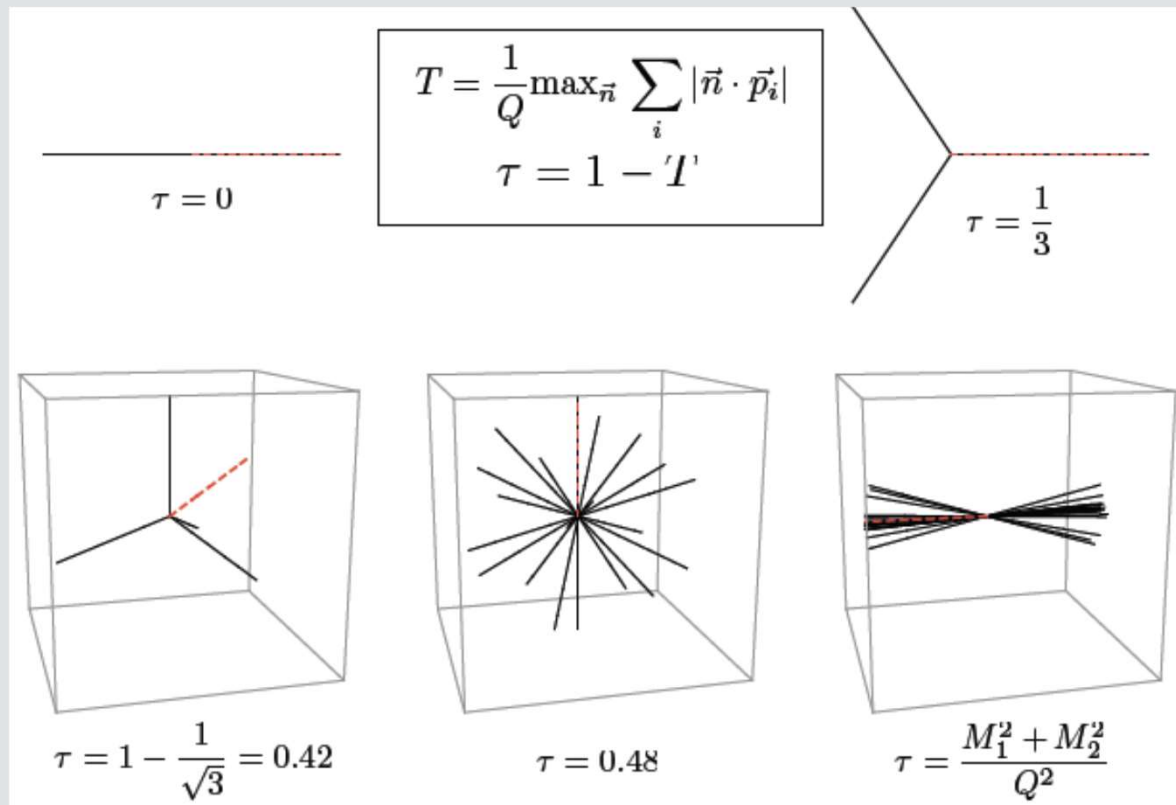

@TBA

PQCD: Event Shapes - III

Thrust distributions as observed at LEP

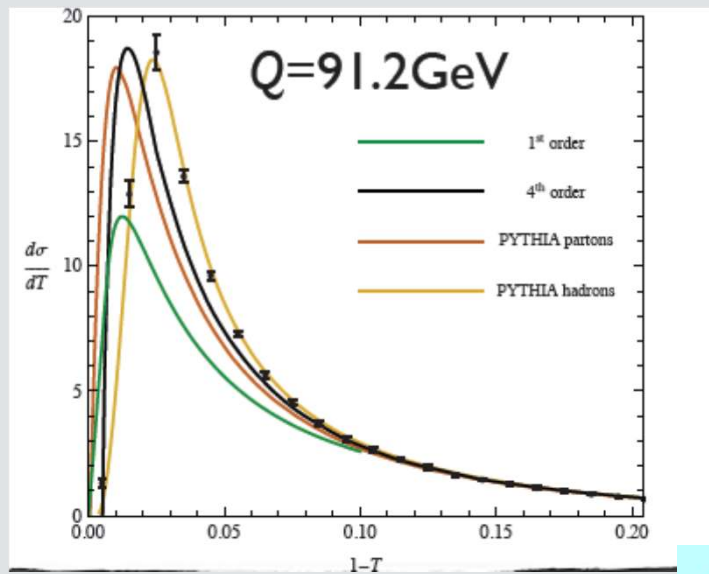

ALEPH

@TBA

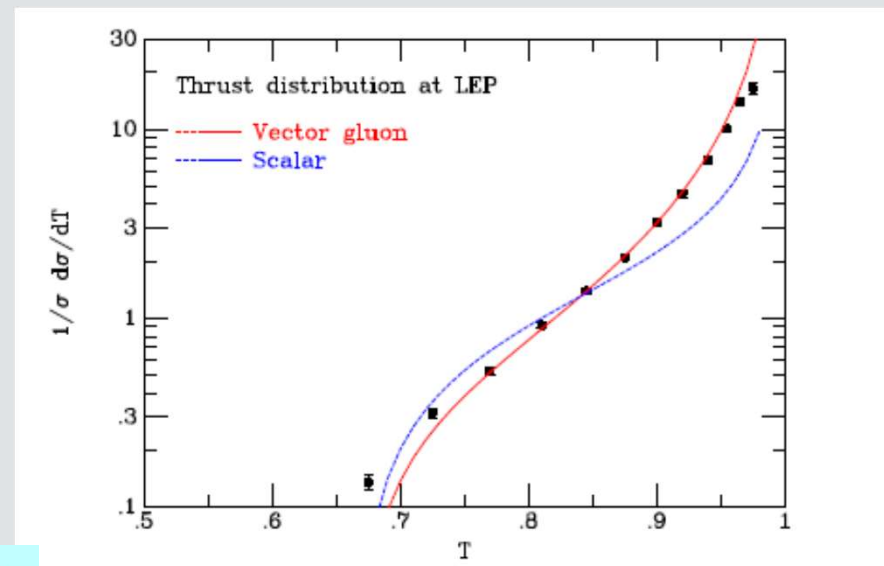

DELPHI

PQCD: Event Shapes - IV

Another useful variable: y_3

Fix event to 3 jets

$$y_3 = \min(y_{ij})$$

y_3 distribution depends on α_s

Fitting α_s to event-shape distributions

Example with y_3 :

restrict fit range
to three-jet region;
data also well described
outside fit range

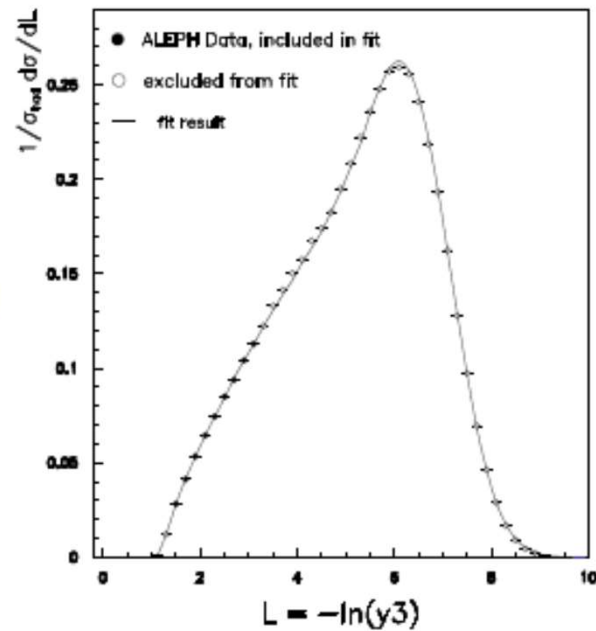

$$\alpha_s(M_Z) = 0.1195 \pm 0.0002 \text{ (stat.)} \pm 0.0038 \text{ (sys.)}$$

PQCD: Jets in e^+e^- Collisions - I

Absolute number of jets ill defined, both in theory and experiment

Need to compare QCD prediction ...

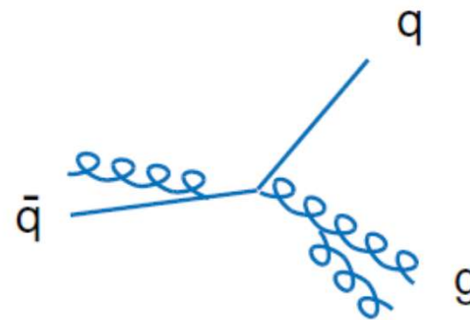

with measurement ...

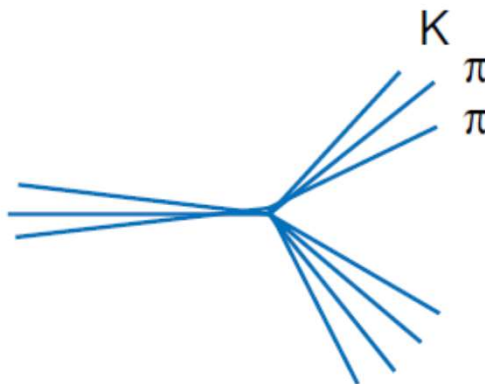

PQCD: Jets in e^+e^- Collisions - II

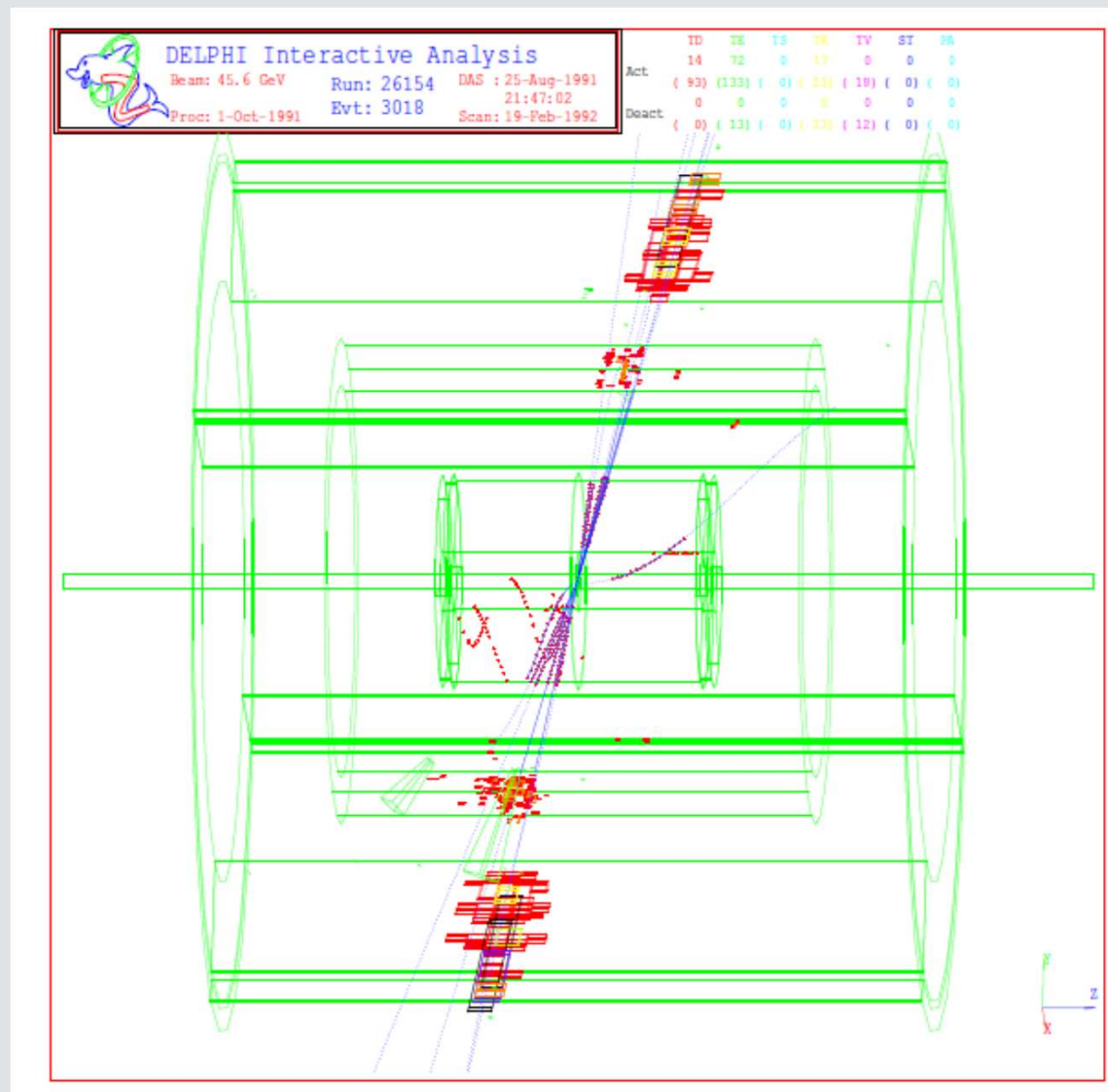

PQCD: Jets in e^+e^- Collisions - III

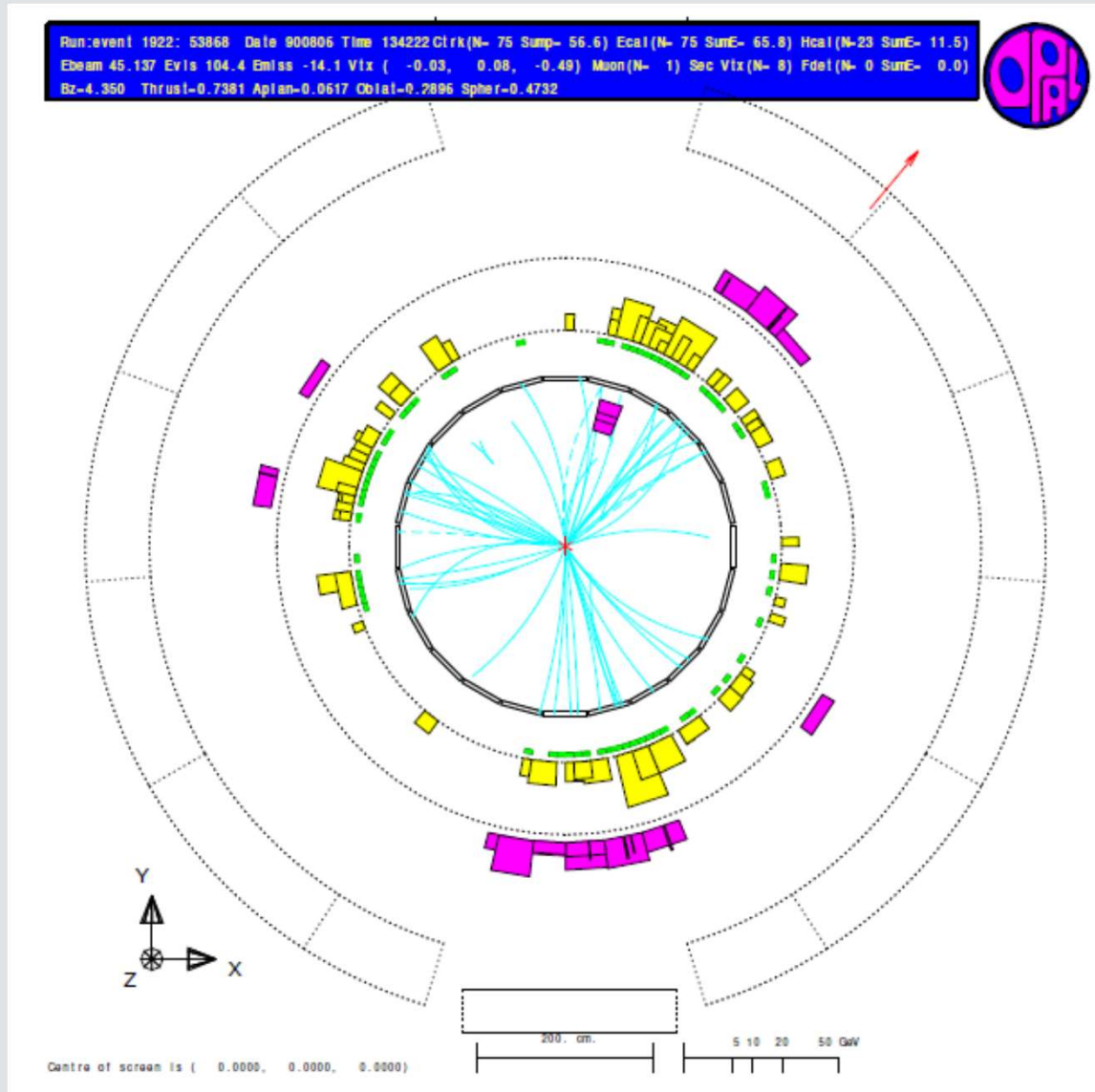

PQCD: Jets in e^+e^- Collisions - IV

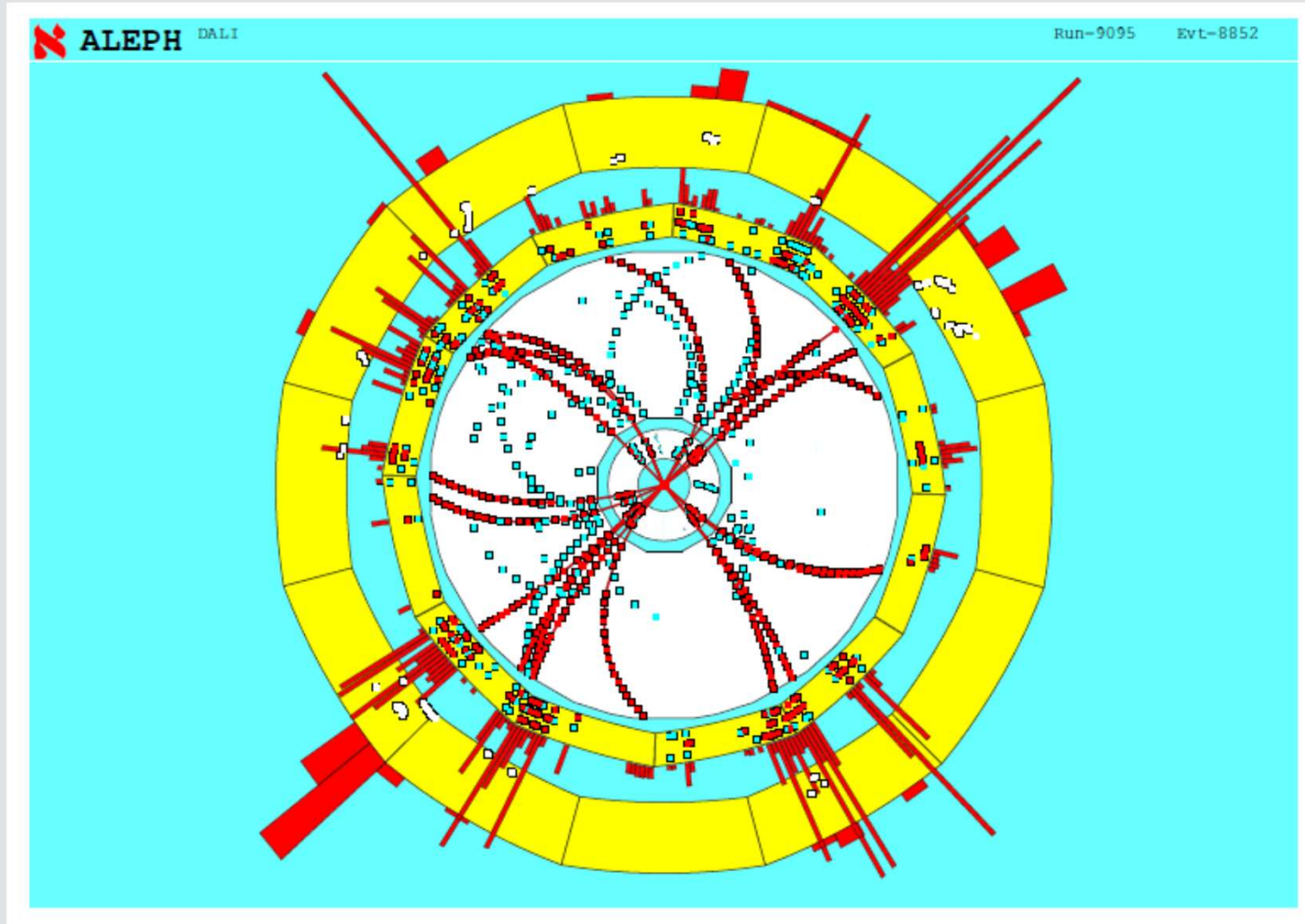

PQCD: Jets in e^+e^- Collisions - V

Define number of jets as a function of some *resolution parameter*, according to a *clustering algorithm*

Example: JADE *algorithm*

By fixing a y parameter as

$$m_{thresh}^2 = ys$$

compare the (invariant mass)² of each parton pair to m_{thresh}^2

$(p_i + p_j)^2 < ys \quad i, j = 1, N \rightarrow (i, j)$ replaced by a single pseudoparticle

$$N \rightarrow N - 1$$

Iterate until $N \rightarrow N_{hit}$

$$(p_i + p_j)^2 > ys \quad \forall i, j = 1, N_{hit}$$

Then:

$$N_{hit} = N_{jet} \quad \text{Of course, } \begin{aligned} Rate_{2jet} &= Rate_{2jet}(y) \\ Rate_{3jet} &= Rate_{3jet}(y) \end{aligned}$$

Extend to n partons \rightarrow QCD predicts $R_{k-jet}(y)$!

PQCD: Jets in e^+e^- Collisions - VI

Define $y=y_{cut}$

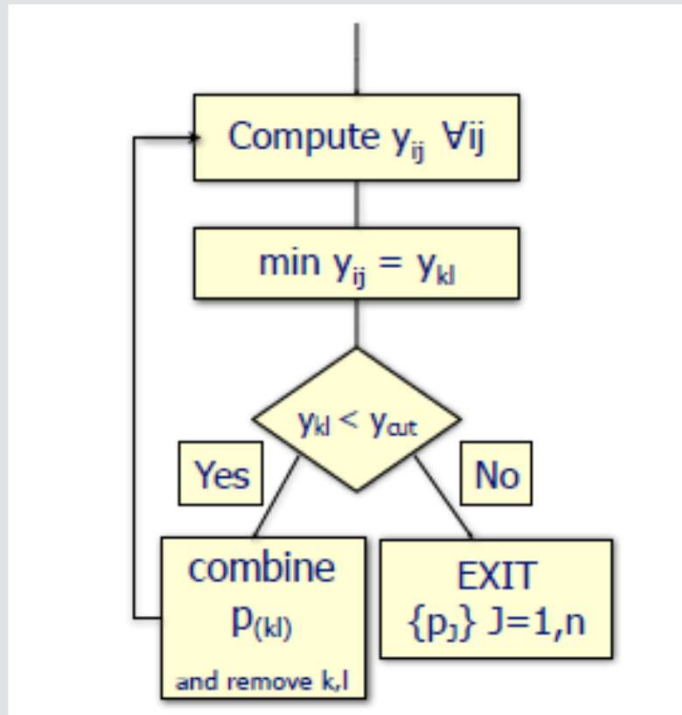

$$y_{ij} = \frac{2E_i E_j (1 - \cos \theta_{ij})}{s} \simeq \frac{m_{ij}^2}{s}$$

$$p_i = (E_i, \vec{p}_i)$$
$$p_j = (E_j, \vec{p}_j)$$

Exit with 4-momenta of n jets

PQCD: Jets in e^+e^- Collisions - VII

Fall 2020

Ezio Menichetti - Università di Torino

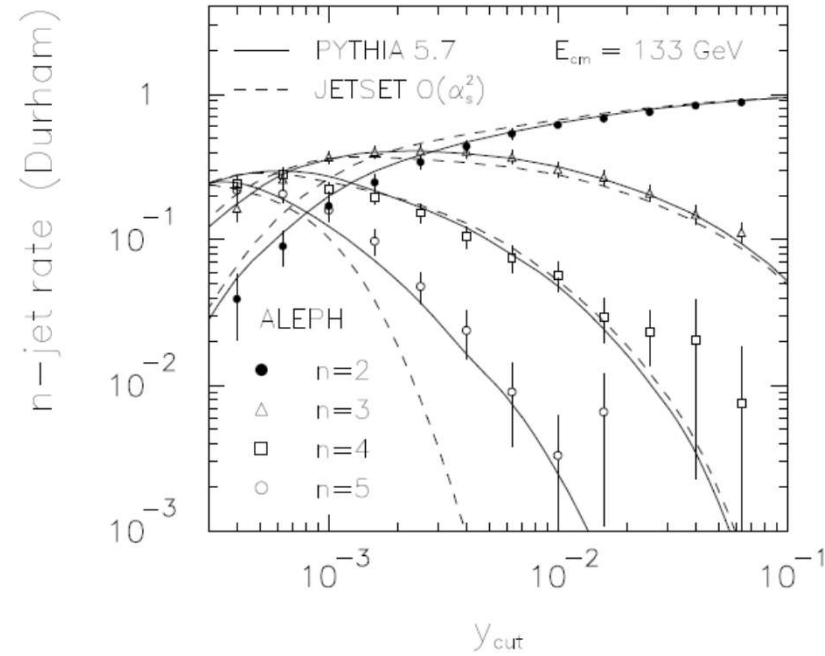
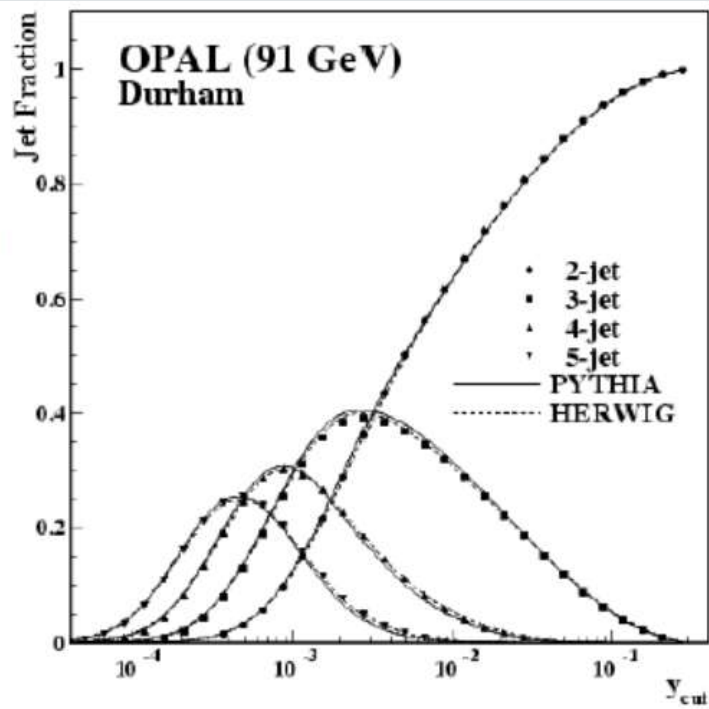

PQCD: Jets in e^+e^- Collisions - VIII

Exceptional 3-jet event from OPAL

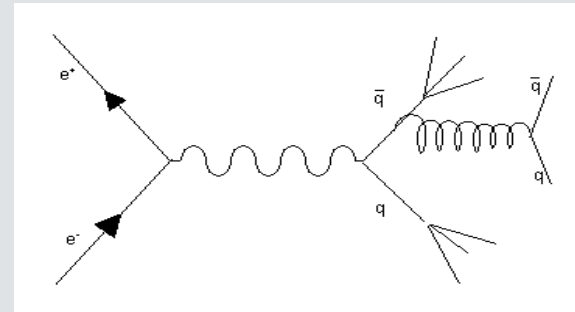
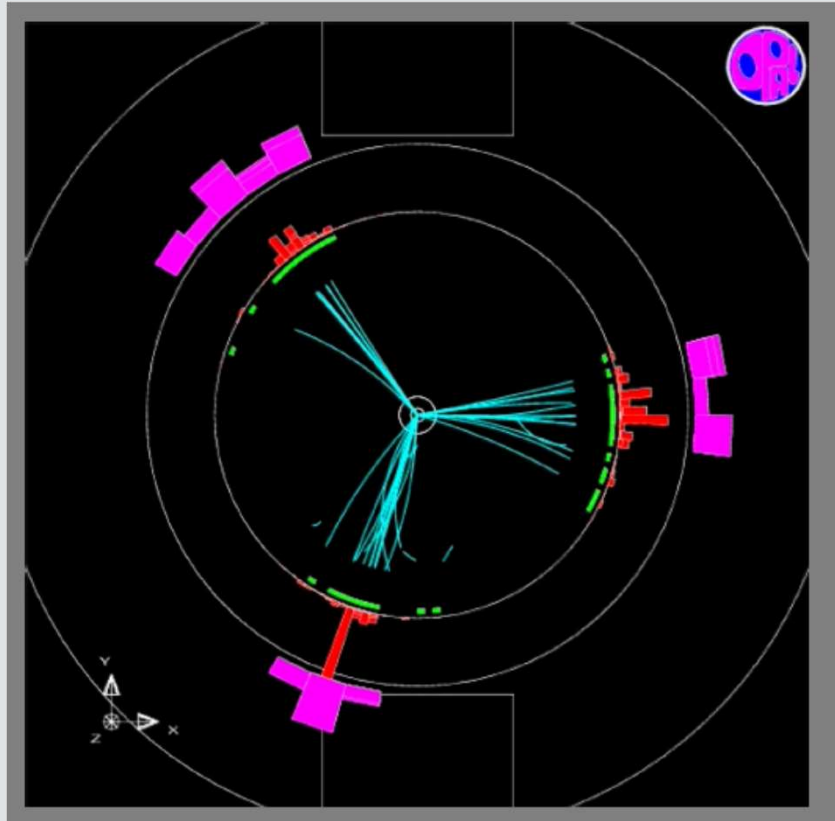

PQCD: Jets in e^+e^- Collisions - IX

Get a measurement of α_s :

$$\alpha_s(35\text{GeV}) = 0.146 \pm 0.03$$

$$\alpha_s(M_{Z^0}) = 0.124 \pm 0.0043$$

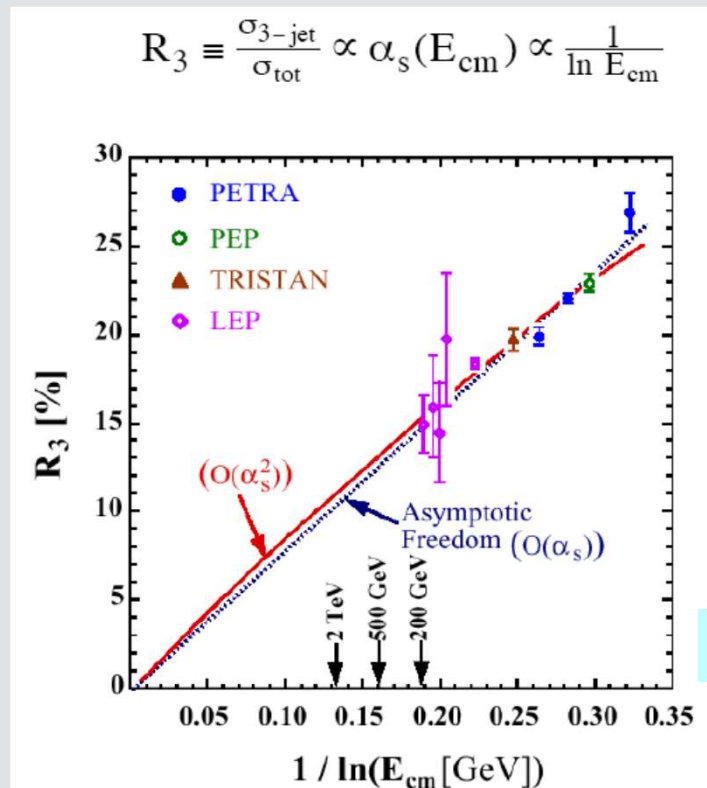

@TBA

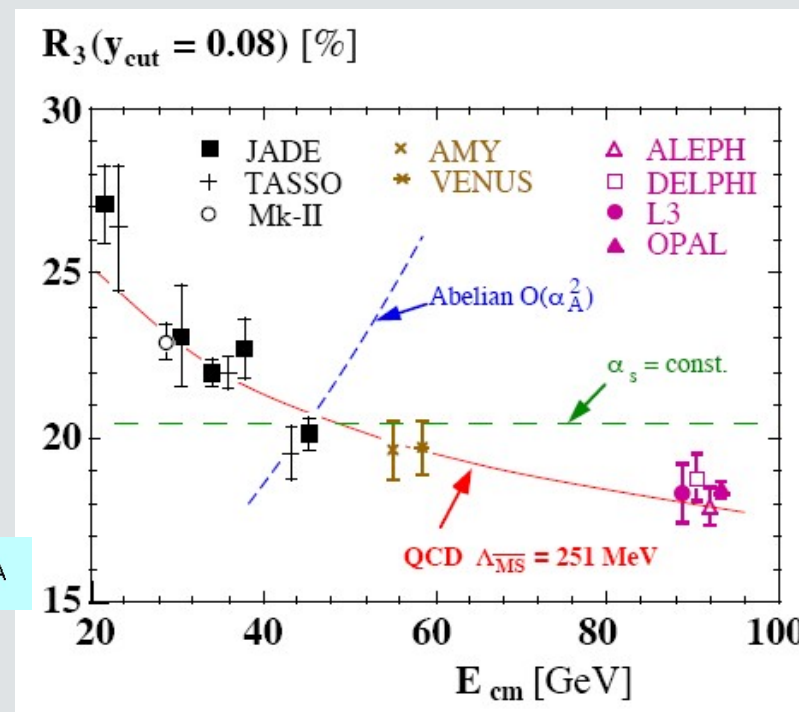

PQCD: Jets in e^+e^- Collisions - X

Is QCD really $SU(3)$?

Test for non-Abelian couplings at LEP: 4 jets events

Special angular correlation from 3-gluon vertex amplitude

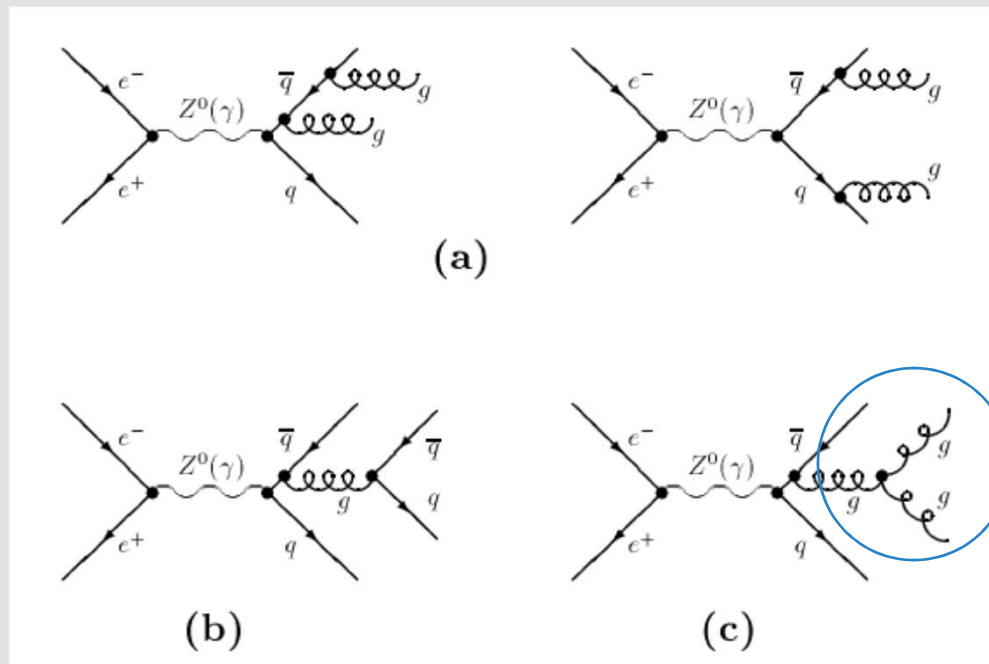

PQCD: Jets in e^+e^- Collisions - XI

Look at distribution of a special angle, sensitive to non-Abelian couplings:

Bengtson-Zerwas angle between
energy-ordered jet axes
($E_1 \geq E_2 \geq E_3 \geq E_4$)

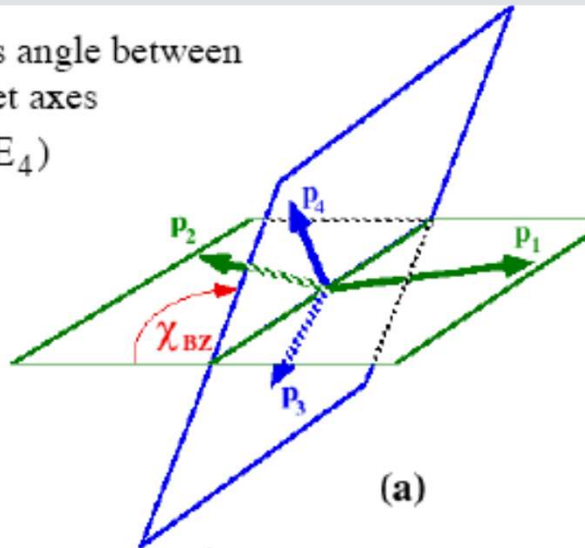

@TBA

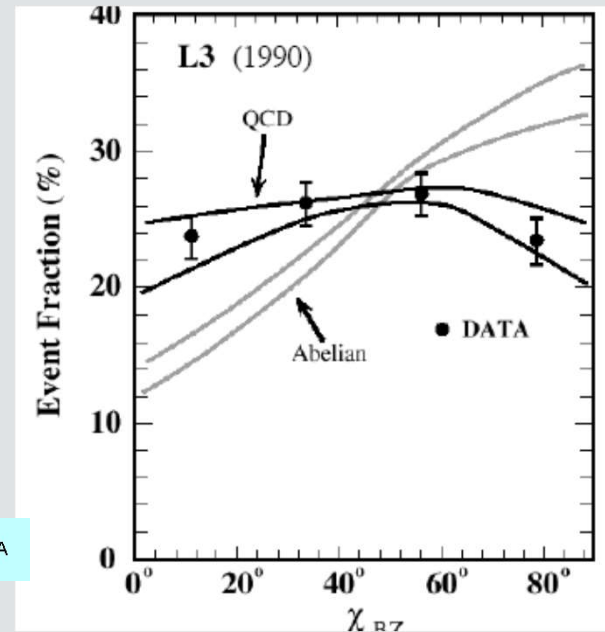

PQCD: Jets in e^+e^- Collisions - XII

Any diagram:

Need to average over initial/sum over final colors

Similar to average, sum over spin projections for unpolarized cross sections

But: $SU(3)$ algebra, rather than $SU(2)$

→ Color factor: Numerical constant appearing in every amplitude

$SU(3)$: 3 constants, appearing in all color factors

$$\sum_{k=1}^8 \sum_{\eta=1}^3 \frac{\lambda_{\alpha\eta}^k}{2} \frac{\lambda_{\eta\beta}^k}{2} = \delta_{\alpha\beta} C_F \rightarrow C_F = \frac{4}{3}$$

$$\sum_{j=1}^8 \sum_{k=1}^8 f^{jkm} f^{jkn} = \delta_{mn} C_A \rightarrow C_A = 3$$

$$\sum_{\alpha=1}^3 \sum_{\beta=1}^3 \frac{\lambda_{\alpha\beta}^m}{2} \frac{\lambda_{\beta\alpha}^n}{2} = \delta_{mn} T_F \rightarrow T_F = \frac{1}{2}$$

4 – *jet* events: Angular distributions allowing for measurement of C_A, C_F, T_F

→ Testing the $SU(3)$ structure of QCD

PQCD: Jets in e^+e^- Collisions - XIII

QCD is SU(3)!

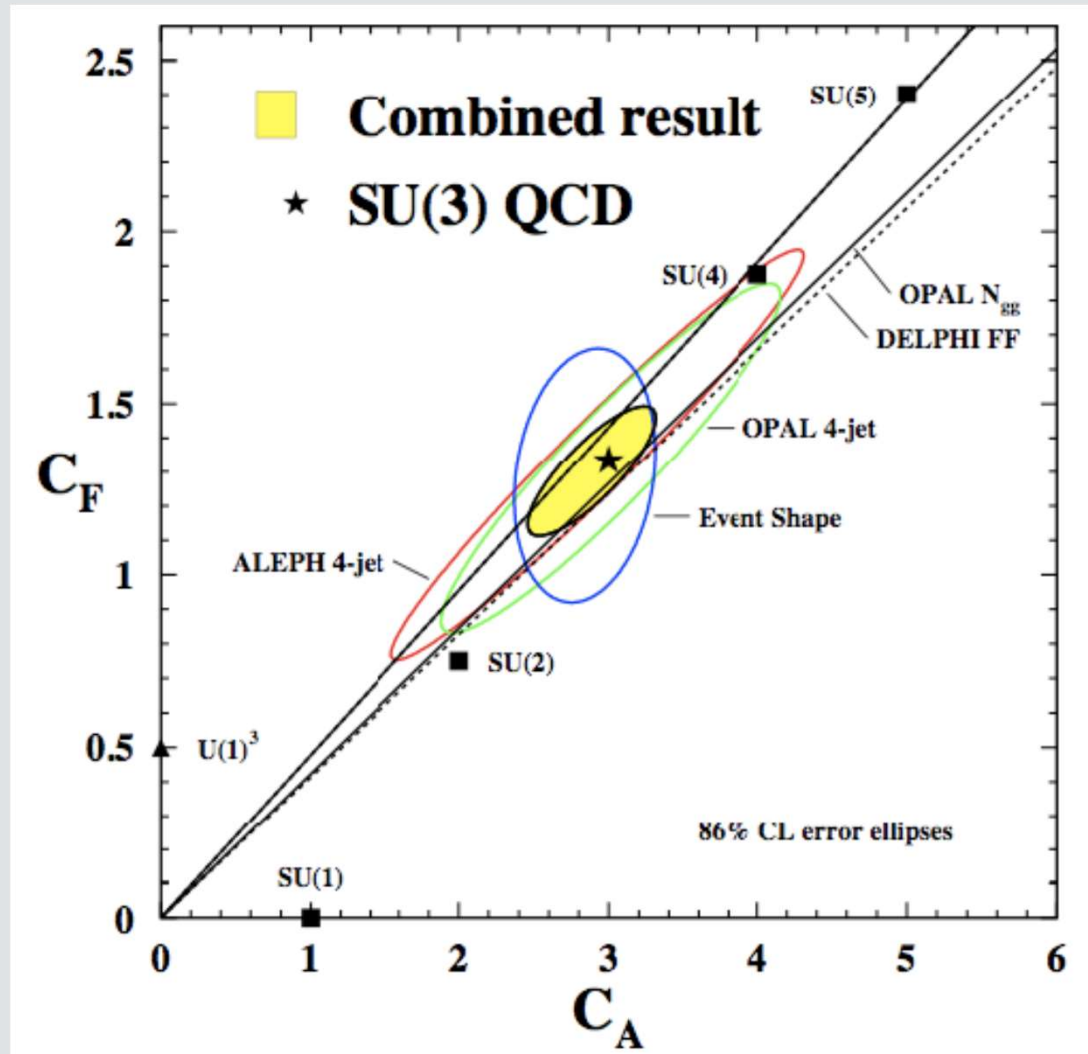

Deep Inelastic Scattering - I

@TBA

Elastic $e-p$ scattering:

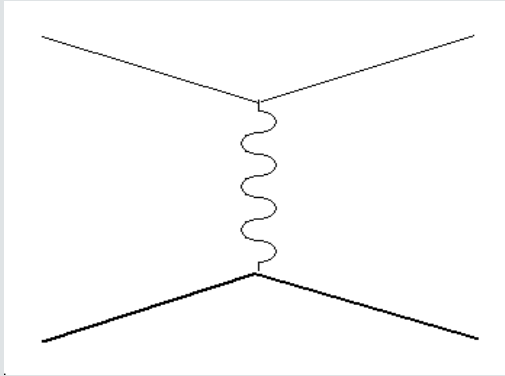

Invariant mass = M

Generalise to inelastic reactions:

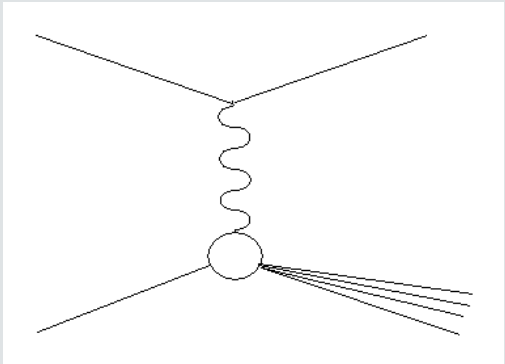

Invariant mass = $W > M$

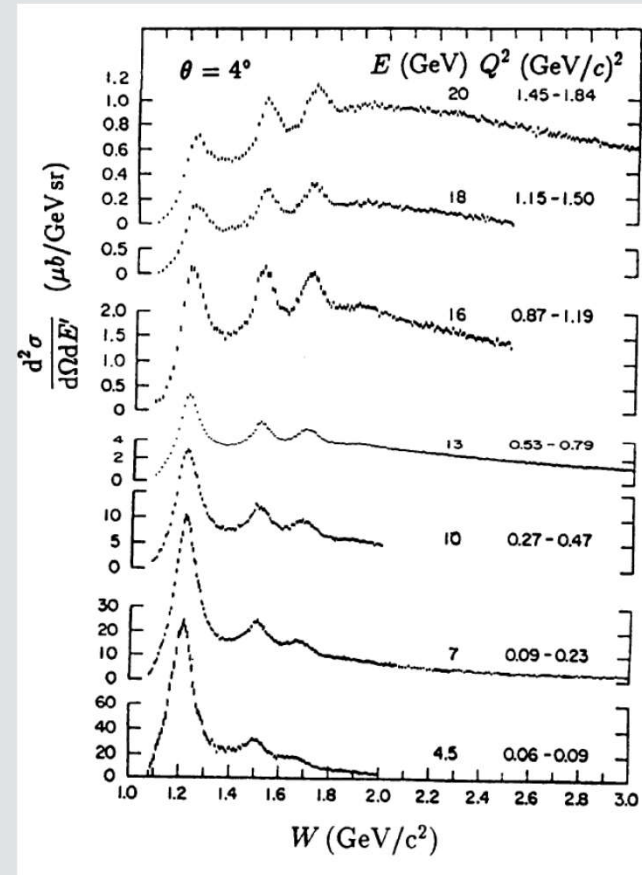

Copious production of *resonances* (nucleon excited states), when q^2 not too big

Deep Inelastic Scattering - II

$$\nu = \frac{Q^2}{2M} \rightarrow 2M\nu = Q^2$$

Fully correlated

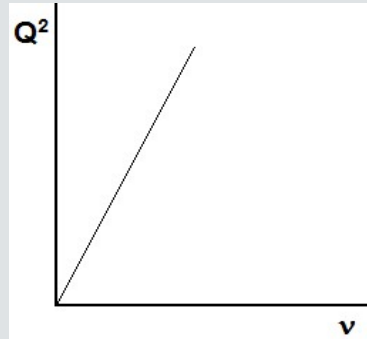

Elastic

$$2M\nu = Q^2 + M'^2 - M^2$$

Fully correlated for any given M'

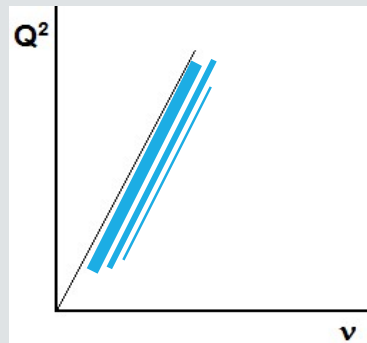

Inelastic

ν, Q^2 uncorrelated

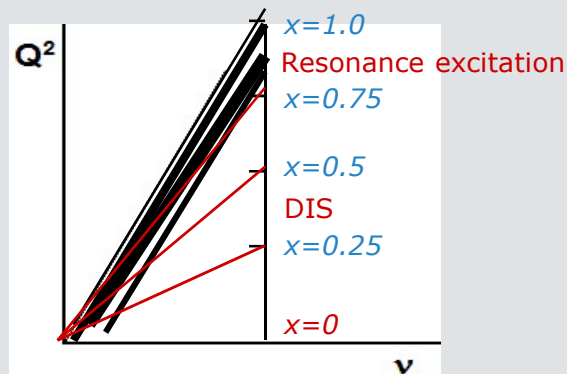

Deep inelastic

Deep Inelastic Scattering - III

Rosenbluth formula for elastic cross section:

$$\frac{d^3\sigma}{dE' d\Omega} = \frac{\alpha^2 \cos^2 \theta/2}{4E^2 \sin^4 \theta/2} \left[\frac{G_E^2(q^2) - \frac{q^2}{4M^2} G_M^2(q^2)}{1 - \frac{q^2}{4M^2}} - \frac{q^2}{2M^2} G_M^2(q^2) \tan^2 \theta/2 \right] \delta\left(\nu + \frac{q^2}{2M}\right)$$

$$\left. \begin{array}{l} q^2 \simeq -4EE' \sin^2 \theta/2 \\ \nu = E - E' \end{array} \right\} \rightarrow \delta\left(\nu + \frac{q^2}{2m_\mu}\right) = \delta\left(E - E' - \frac{2E}{m_\mu} E' \sin^2 \theta/2\right)$$

$q^2, \nu \leftrightarrow E', \theta$ fully correlated by 4-momentum conservation

Generalise to inelastic cross section:

$$\frac{d\sigma}{d\Omega dE'} = \frac{\alpha^2 \cos^2 \theta/2}{4E^2 \sin^4 \theta/2} \left[F_2(\nu, q^2) + F_1(\nu, q^2) \tan^2 \theta/2 \right]$$

F_1, F_2 : Structure functions, depending on both q^2, ν

Deep Inelastic Scattering - IV

Move to invariant cross section:

$$\frac{d^2\sigma}{dE'd\Omega} \rightarrow \frac{d^2\sigma}{dQ^2 dv}$$

Also introduce:

$$\begin{cases} x = \frac{Q^2}{2Mv} \\ y = \frac{v}{E_1} \end{cases}$$

$$\rightarrow \frac{d^2\sigma}{dxdy} = \frac{4\pi\alpha^2 ME_1}{Q^4} \left[2xF_1(x) \left(\frac{1+(1-y)^2}{2} \right) + (1-y)(F_2(x) - 2xF_1(x)) - \frac{M^2 xy F_2}{s - M^2} \right]$$

Bjorken scaling hypothesis:

$$\frac{d^2\sigma}{dxdy} \xrightarrow[\frac{Q^2}{v} \text{ finite}]{Q^2, v \rightarrow \infty} f(x), \quad x = \frac{Q^2}{2Mv}$$

$f(x)$: Universal function of x , Q^2 independent

Parton Density Function

Deep Inelastic Scattering - V

F_2 : Universal function of x q^2 -independent!

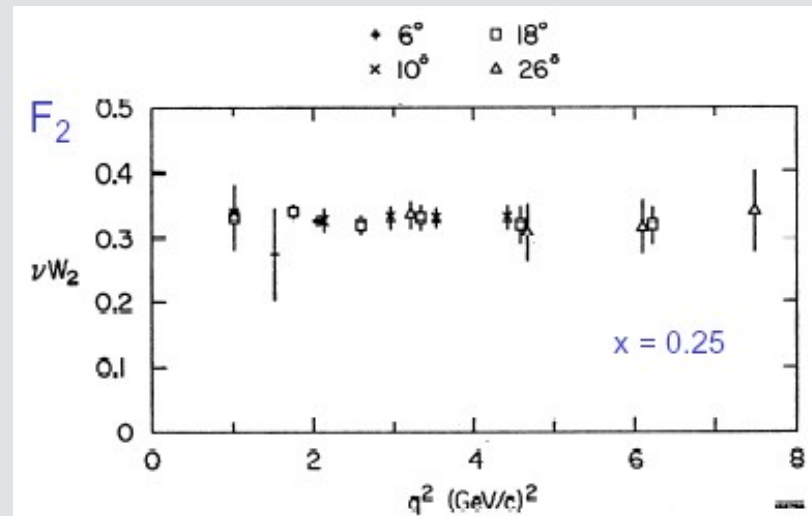
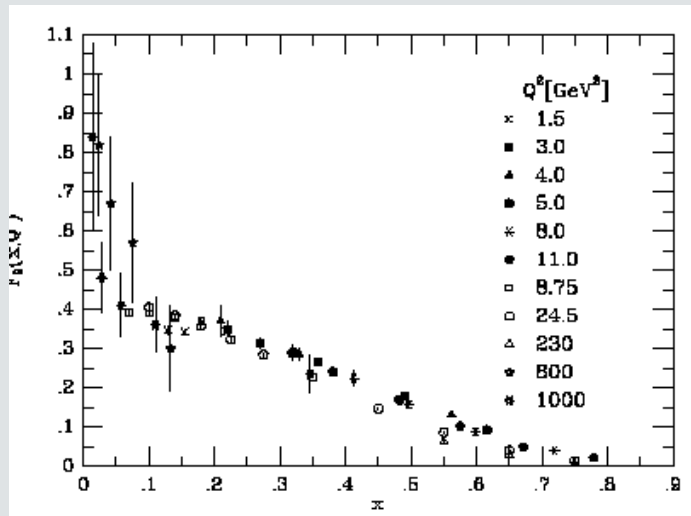

@TBA

PQCD: DIS Scaling Violations - I

Feynman interpretation of scaling (1969): *Partons*

Nucleon constituents, free particles constrained within the nucleon

x = momentum fraction carried by the struck parton

PDF: statistical distribution of x for partons

Write down F_2 in terms of PDFs

$$\frac{F_2(x)}{x} = \sum_i z_i^2 n_i \delta\left(x - \frac{m_i}{M}\right) \rightarrow \frac{F_2(x)}{x} = \sum_i z_i^2 \underbrace{q_i(x)}$$

$$p = uud$$

$$F_2^p(x) = x \left[\left(\frac{2}{3}\right)^2 u_p(x) + \left(-\frac{1}{3}\right)^2 d_p(x) \right]$$

$$\rightarrow F_2^p(x) = x \left[\frac{4}{9} u_p(x) + \frac{1}{9} d_p(x) \right]$$

$$n = ddu$$

$$F_2^n(x) = x \left[\left(-\frac{1}{3}\right)^2 d_n(x) + \left(\frac{2}{3}\right)^2 u_n(x) \right]$$

From isospin symmetry:

$$F_2^n(x) = x \left[\left(-\frac{1}{3}\right)^2 u_p(x) + \left(\frac{2}{3}\right)^2 d_p(x) \right]$$

$$\rightarrow F_2^n(x) = x \left[\frac{1}{9} u_p(x) + \frac{4}{9} d_p(x) \right]$$

PQCD: DIS Scaling Violations - II

Consider the deuteron structure function:

$$\begin{aligned}F_2^d(x) &= \frac{1}{2}(F_2^p + F_2^n) = \frac{5}{9}x[u_p(x) + d_p(x)] \\&\rightarrow F_2^n(x) = F_2^d(x) - F_2^p(x) \\&= \frac{5}{18}x[u_p(x) + d_p(x)] - \frac{1}{9}x[u_p(x) - 4d_p(x)] \\&= \frac{3}{18}x[u_p(x) - d_p(x)]\end{aligned}$$

Finally extract PDFs from measured F_2

$$xu_p(x) = xd_n(x) = 3F_2^p(x) - \frac{6}{5}F_2^d(x)$$

$$xu_n(x) = xd_p(x) = 3F_2^p(x) + \frac{24}{5}F_2^d(x)$$

PQCD: DIS Scaling Violations - III

Take a Hydrogen atom:

Common wisdom: “A bound state of proton + electron”

But: Consider the effect of radiative corrections (e.g. loops)

Then we should be more precise:

Hydrogen = (Proton+Electron)_{Valence} + (Positrons+Electrons+Photons)_{Sea}

Can we say valence and sea particles are fundamentally different? Well,...

In a bound state, both are off mass shell

Both are active in yielding measurable effects (Coulomb levels vs. Lamb shift,..)

Sea particles yield small corrections to levels determined by valence e+p

Take a hadron:

Hadron = (Quarks/Antiquarks)_{Valence} + (Quarks/Antiquarks+Gluons)_{Sea}

Since $a_s \gg a$, *sea effects are much larger in QCD*

PQCD: DIS Scaling Violations - IV

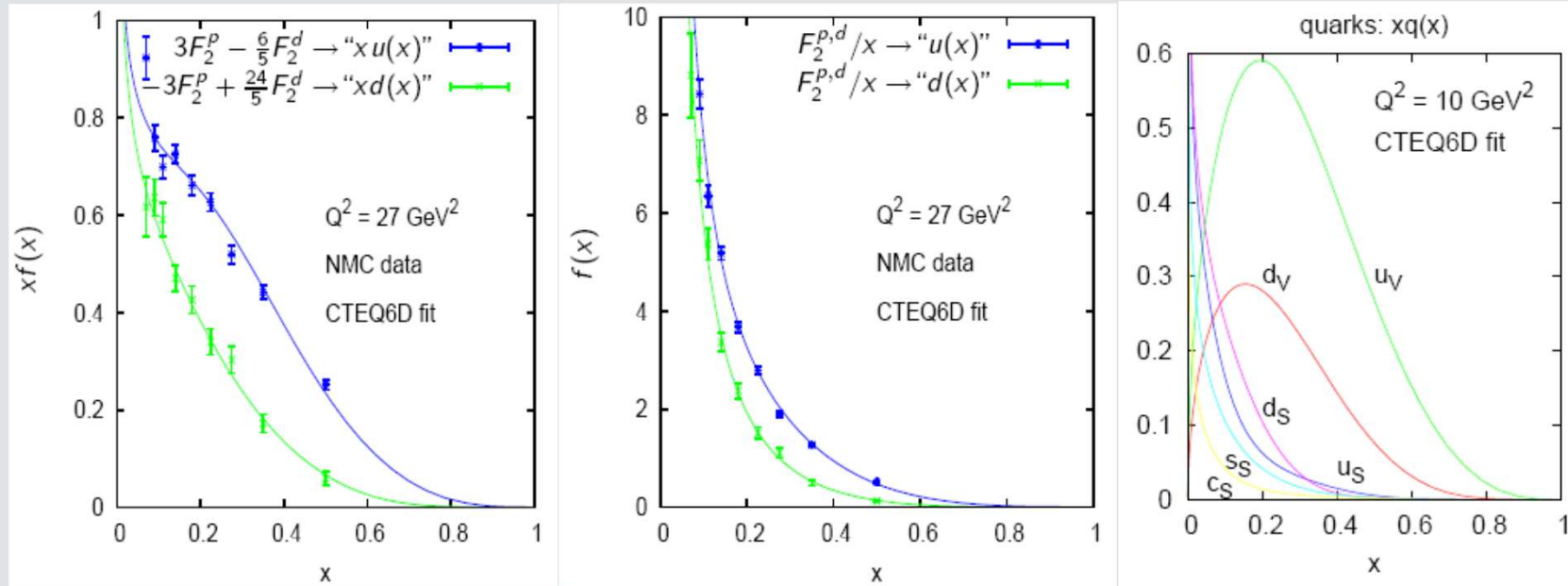

Among parton model predictions: *Sum Rules* (= Integral relations) for PDFs
 Examples: Proton valence quark content is uud

@TBA

$$\int [u_p(x) - \bar{u}_p(x)] dx = 2$$

$$\int [d_p(x) - \bar{d}_p(x)] dx = 1$$

$$\int [s_p(x) - \bar{s}_p(x)] dx = 0$$

PQCD: DIS Scaling Violations - V

Our picture of structure functions

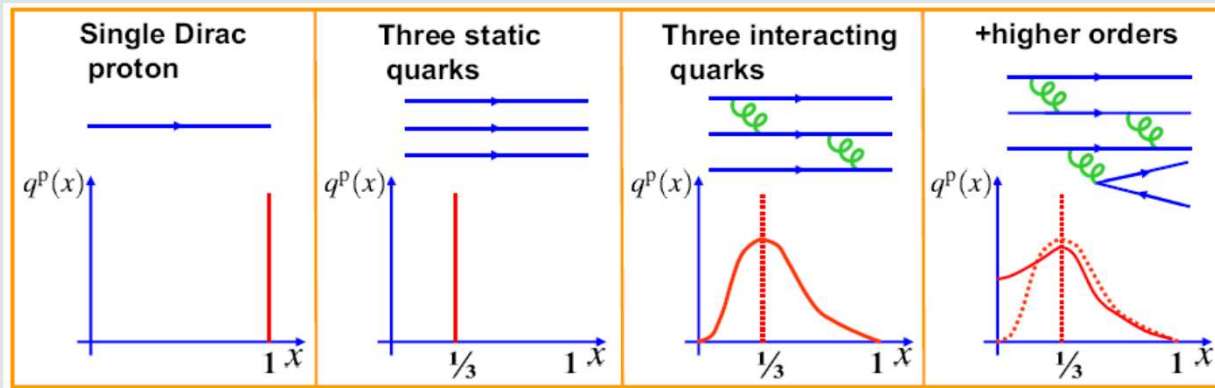

@TBA

Observe small deviations from scaling: $F_2(x) \rightarrow F_2(x, Q^2)$

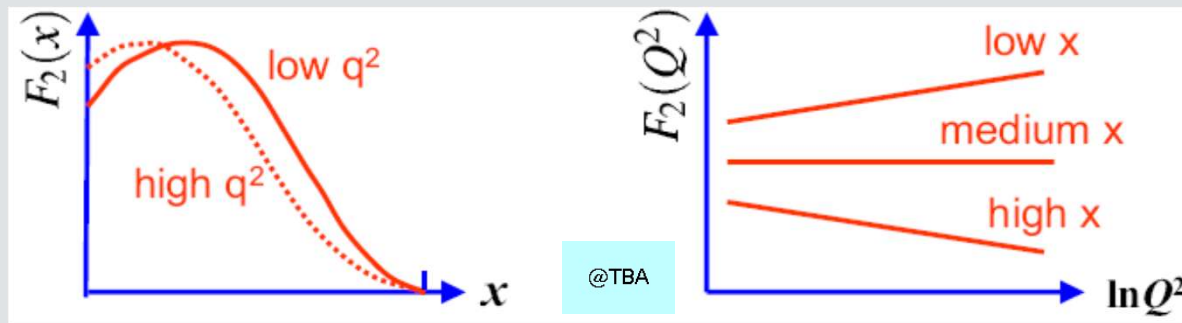

@TBA

PQCD: DIS Scaling Violations - VI

QCD on $F_2(x, Q^2)$:

x – dependence \rightarrow Non perturbative \rightarrow Not predicted

Q^2 – dependence \rightarrow Perturbative \rightarrow Predicted !

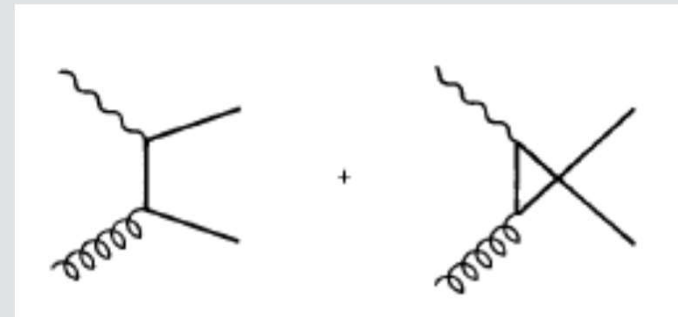
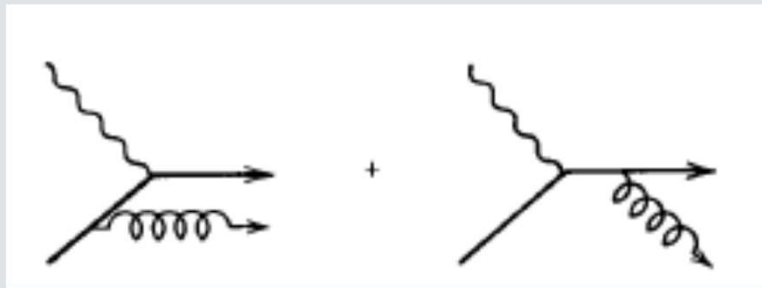

Dokshitzer-Gribov-Lipatov-Altarelli-Parisi (DGLAP) Equations:

Successful prediction of Q^2 evolution of structure functions

PQCD: DIS Scaling Violations -VII

First order (NLO) QCD corrections to naive Quark Parton Model:

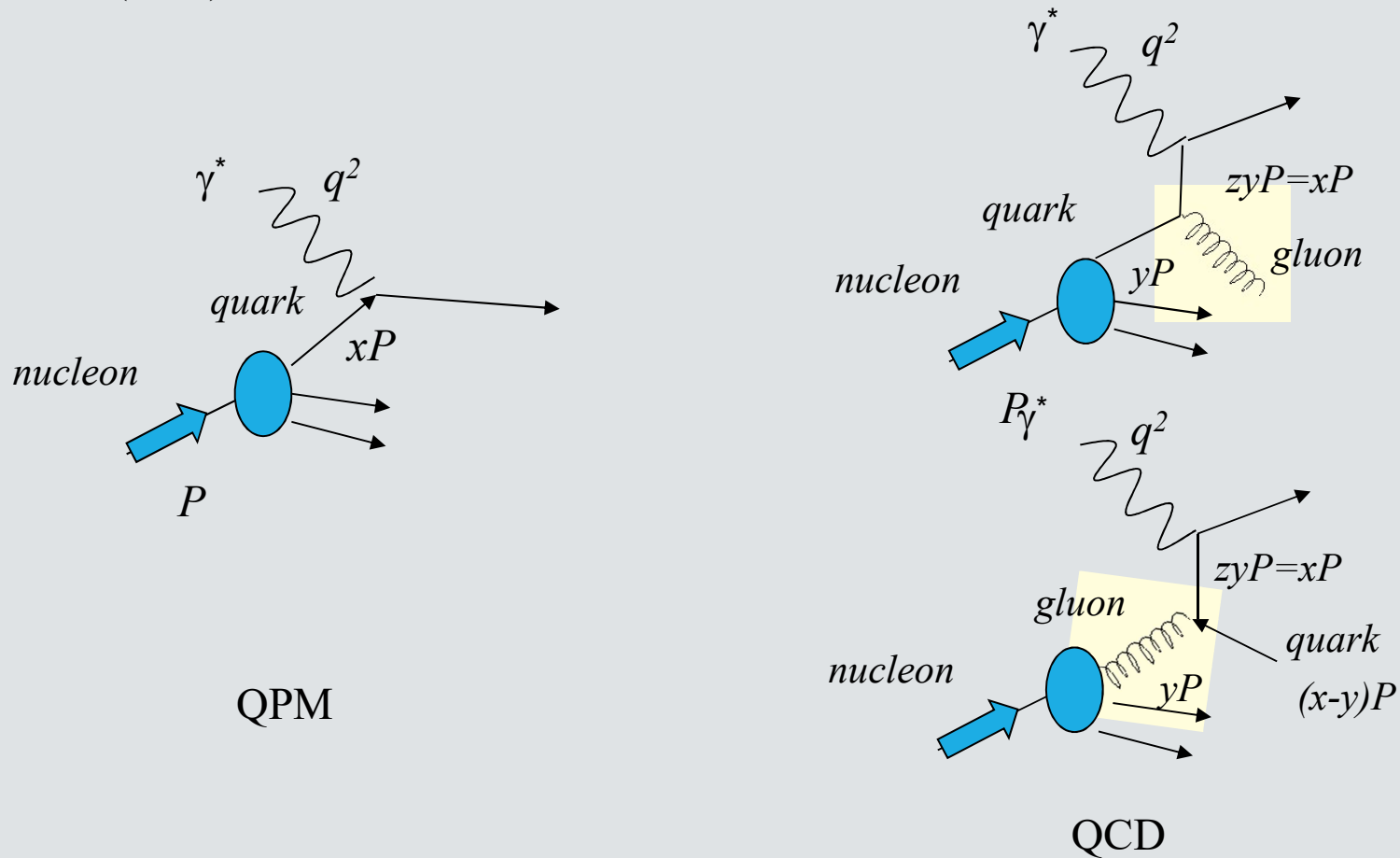

PQCD: DIS Scaling Violations -VIII

The bottom line:

Measured structure functions at any given Bjorken x depend on quark & gluon densities taken at higher fractional momentum $y > x$

This originates a slow Q^2 dependence

Core physics: Probabilities of QCD radiative/scattering processes $P_{qq}(x/y)$, $P_{gq}(x/y)$

Usually called *splitting functions*

$$\frac{F_2(x)}{x} = 2F_1(x) = \sum_i e_i^2 q_i(x)$$

$$\rightarrow \frac{F_2(x)}{x} = \sum_i e_i^2 \int_0^1 q_i(y) \delta(x-y) dy$$

$$\rightarrow \frac{F_2(x)}{x} = \sum_i e_i^2 \int_0^1 q_i(y) \delta\left(1 - \frac{x}{y}\right) \frac{dy}{y}$$

$$z = \frac{x}{y}$$

$$\rightarrow \frac{F_2(x)}{x} = \sum_i e_i^2 \int_0^1 q_i(y) \left[\delta\left(1 - \frac{x}{y}\right) + \sigma_{qq}(z) \right] \frac{dy}{y} \quad \text{QCD corrections}$$

Quark-Parton Model

Reminder:

$$\delta(-x) = \delta(x), \quad \delta[a(1-x)] = \frac{1}{a} \delta(1-x)$$

$$\rightarrow \delta(x-y) = \delta\left[y\left(1 - \frac{x}{y}\right)\right] = \frac{1}{y} \delta\left(1 - \frac{x}{y}\right)$$

PQCD: DIS Scaling Violations - IX

Just as an example: Gluon radiation splitting function at leading order (LO)
Almost carbon-copy of Compton effect

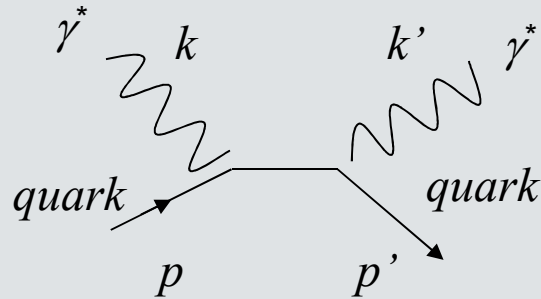

$$\gamma^*(k) q(p) \rightarrow \gamma^*(k') q(p')$$

$$\left(\frac{d\sigma}{d\Omega}\right)_{\gamma q \rightarrow \gamma q} = \frac{\alpha^2 e_q^2}{2s} \left(\frac{-u}{s} - \frac{s}{u} - \frac{2tq^2}{su} \right)$$

$$k \leftrightarrow q$$

$$k' \leftrightarrow p'$$

$$u = (k-p')^2 \quad t = (q-p')^2$$

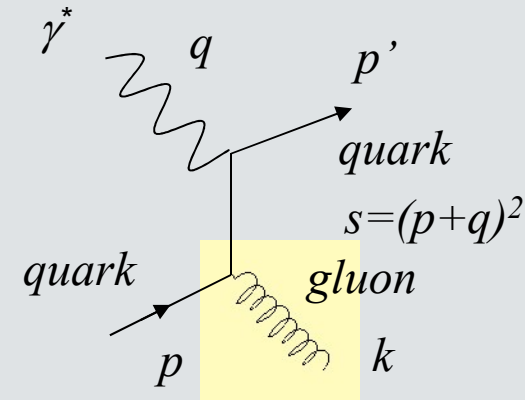

$$\gamma^*(q) q(p) \rightarrow q(p') g(k)$$

$$\left(\frac{d\sigma}{d\Omega}\right)_{\gamma q \rightarrow gq} = \frac{C_F \alpha \alpha_s e_q^2}{2s} \left(\frac{-t}{s} - \frac{s}{t} - \frac{2uq^2}{st} \right)$$

PQCD: DIS Scaling Violations - X

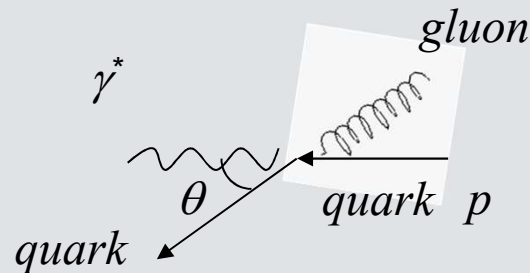

$$dp_T^2 = d(p^2 \sin^2 \theta) = 2p^2 \sin \theta \underbrace{\cos \theta}_{\approx 1} d\theta = 2p^2 d(\cos \theta)$$

$$\rightarrow dp_T^2 = \frac{s}{2} d(\cos \theta) = \frac{s}{2} \frac{d\Omega}{4\pi} \rightarrow \frac{d\sigma}{d\Omega} = \frac{s}{8\pi} \frac{d\sigma}{dp_T^2} \rightarrow \frac{d\sigma}{dp_T^2} = \frac{8\pi}{s} \frac{d\sigma}{d\Omega}$$

$$\rightarrow \frac{d\sigma}{dp_T^2} = \frac{8\pi}{s} \frac{C_F \alpha_S e_q^2}{2s} \left(\frac{-t}{s} - \frac{s}{t} - \frac{2uq^2}{st} \right)$$

Reminder (Bjorken): $x = -\frac{q^2}{2P \cdot q}$

Define: $z = -\frac{q^2}{2p \cdot q} = -\frac{q^2}{s - q^2}$

$$\rightarrow \left(\frac{d\sigma}{dp_T^2} \right)_{\gamma q \rightarrow gq} \propto \frac{C_F \alpha_S e_q^2}{p_T^2} P_{qq}(z), \quad P_{qq}(z) \equiv \frac{1+z^2}{1-z^2}$$

PQCD: DIS Scaling Violations - XI

Integrate 'Compton-like' differential cross-section between:

λ lower cutoff (\leftarrow no divergences), $\frac{\hat{s}}{4}$ upper cutoff (\leftarrow kinematical), \hat{s} partonic CM energy squared

$$\sigma_{qq}(z) = \int_{\lambda}^{p_T^2 \max = \frac{\hat{s}}{4}} \frac{d\sigma}{dp_T^2} dp_T^2 \propto \frac{C_F \alpha \alpha_S e_q^2}{s} P_{qq}(z) \ln \left(-\frac{q^2}{\lambda} \right)$$

$$\text{Redefine : } P_{qq}(z) \equiv \frac{\alpha e_q^2 C_F}{2\pi s} \frac{1+z^2}{1-z^2} \rightarrow \frac{F_2(x)}{x} = \sum_i e_i^2 \int_x^1 q_i(y) \left[\delta \left(1 - \frac{x}{y} \right) + \frac{\alpha_S}{2\pi} P_{qq}(z) \ln \left(\frac{Q^2}{\lambda} \right) \right] \frac{dy}{y}$$

$$\rightarrow \frac{F_2(x)}{x} = \sum_i e_i^2 \underbrace{\left[q_i(x) + \int_x^1 q_i(y) \frac{\alpha_S}{2\pi} \ln \left(\frac{Q^2}{\lambda} \right) P_{qq} \left(\frac{x}{y} \right) \frac{dy}{y} \right]}_{q_i(x, Q^2)}$$

$$q_i(x, Q^2) = q_i(x) + \underbrace{\int_x^1 q_i(y) \frac{\alpha_S}{2\pi} \ln \left(\frac{Q^2}{\lambda} \right) P_{qq} \left(\frac{x}{y} \right) \frac{dy}{y}}_{\Delta q_i(x, Q^2)}$$

$$\rightarrow \Delta q_i(x, Q^2) = q_i(x, Q^2) - q_i(x) = \int_x^1 q_i(y) \frac{\alpha_S}{2\pi} \underbrace{(\ln Q^2 - \ln \lambda)}_{\Delta \ln Q^2} P_{qq} \left(\frac{x}{y} \right) \frac{dy}{y}$$

$$\rightarrow \frac{\Delta q_i(x, Q^2)}{\Delta \ln Q^2} = \int_x^1 q_i(y) \frac{\alpha_S}{2\pi} P_{qq} \left(\frac{x}{y} \right) \frac{dy}{y} \quad \text{Finite correction to 'bare' PDF}$$

PQCD: DIS Scaling Violations -XII

Take $\lim_{\Delta \ln(Q^2) \rightarrow 0} \Delta q_i(x, Q^2) = dq_i(x, Q^2)$

→ Evolution equation for each quark flavor:

$$\frac{dq_i(x, Q^2)}{d \ln(Q^2)} = \int_x^1 q_i(y, Q^2) \frac{\alpha_s}{2\pi} P_{qq} \left(\frac{x}{y} \right) \frac{dy}{y},$$

Observe: $q_i(x) \rightarrow q_i(x, Q^2)$,

because infinitesimal increment refers to generic $q_i(x, Q^2)$ rather than 'bare'

This is actually incomplete:

We forgot to add the contribution from the 2nd diagram..

$$\rightarrow \frac{dq(x, Q^2)}{d \ln(Q^2)} = \frac{\alpha_s(Q^2)}{2\pi} \int_x^1 \left[q(y, Q^2) P_{qq} \left(\frac{x}{y} \right) + g(y, Q^2) P_{gq} \left(\frac{x}{y} \right) \right] \frac{dy}{y}$$

And there is another equation for the evolution of the *gluon* density:

$$\frac{dg(x, Q^2)}{d \ln(Q^2)} = \frac{\alpha_s(Q^2)}{2\pi} \int_x^1 \left[\sum_i q_i(y, Q^2) P_{qg} \left(\frac{x}{y} \right) + g(y, Q^2) P_{gg} \left(\frac{x}{y} \right) \right] \frac{dy}{y}$$

Altarelli - Parisi, or *DGLAP*, equations for the parton densities:

Integro-Differential equations for the Q^2 evolution of the parton densities

PQCD: DIS Scaling Violations -XIII

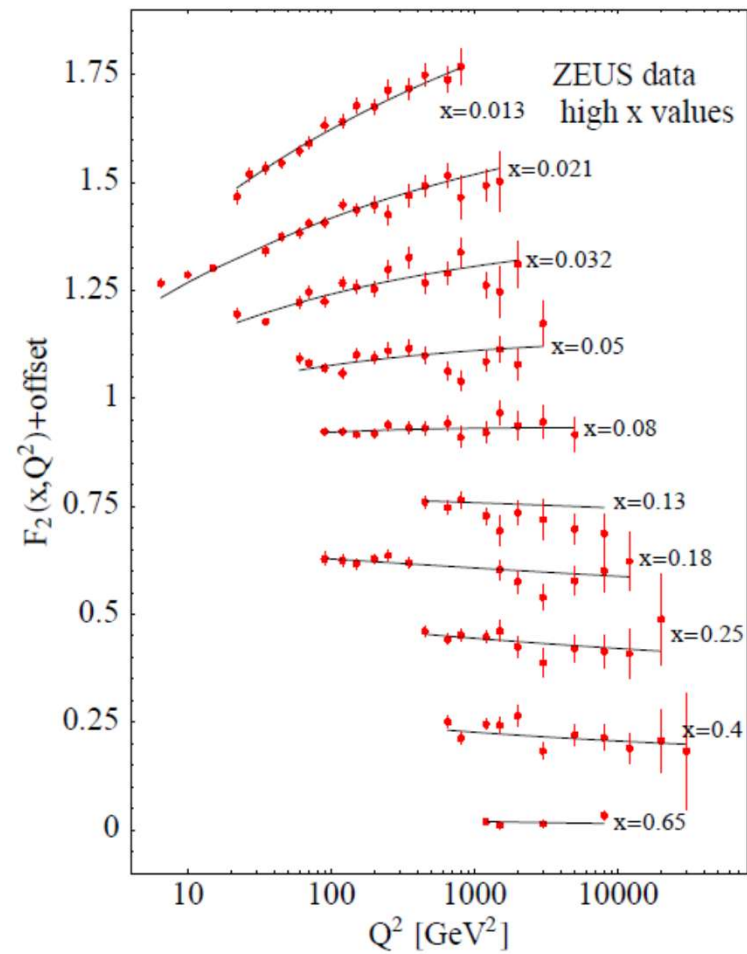
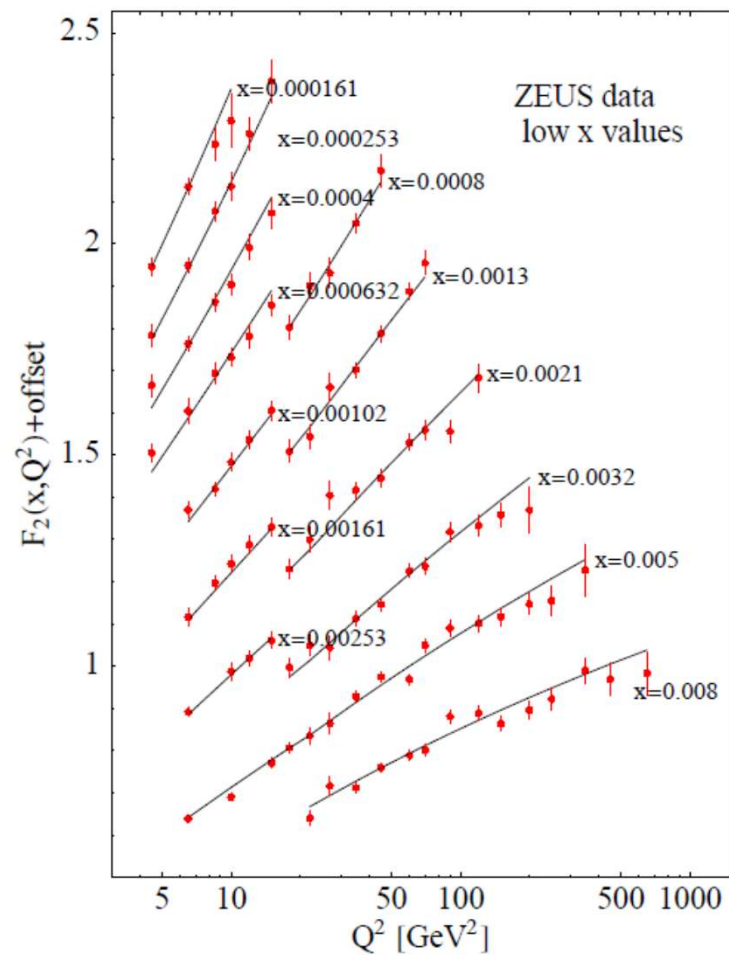

PQCD: DIS Scaling Violations -XIV

PDF Evolution with Q^2

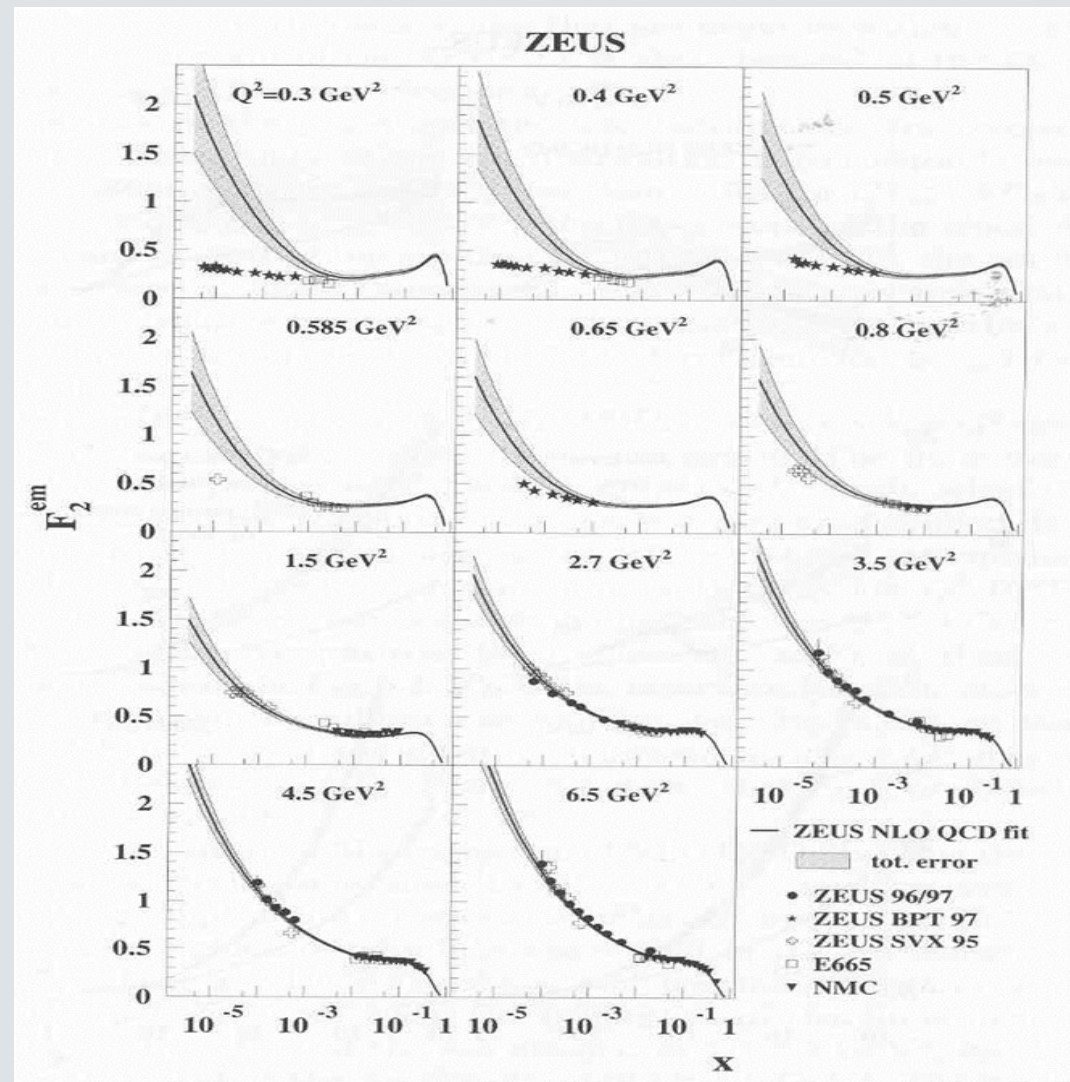

Collider Kinematics - I

Hadron colliders

ISR = Intersecting Storage Ring (CERN '70s)

pp 31 GeV / beam

Some $p\bar{p}$

Sp \bar{p} S = Super $p\bar{p}$ Synchrotron (CERN '80s)

$p\bar{p}$ 270 - 310 GeV / beam

Tevatron (Fermilab early '90s - 2011)

$p\bar{p}$ 1 TeV / beam

RHIC = Relativistic Heavy Ion Collider (BNL 3rd Millennium)

ions 200 GeV / nucleon * beam

LHC = Large Hadron Collider (CERN 3rd Millennium)

pp 7 TeV / beam (presently 4 TeV)

ions 2.7 TeV / nucleon * beam

Collider Kinematics - II

First issue with hadron colliders:

$$\text{Partonic collision CM} \neq \text{Event CM}$$

→ E_{tot} p of parton collision unknown

→ Initial state only partially known

→ Separate collision kinematics into:

Transverse

Longitudinal

Introduce useful kinematical variables: *Rapidity*, *Transverse momentum*

Good news:

CM frame usually identical to LAB

Important exception: ISR (collision angle $15^\circ \rightarrow$ CM moving in LAB)

Not relevant for LHC (collision angle 0.01°)

Collider Kinematics - III

Lorentz transformation $S \rightarrow S'(\beta)$:

$$\begin{pmatrix} z' \\ t' \end{pmatrix} = \begin{pmatrix} \gamma & -\gamma\beta \\ -\gamma\beta & \gamma \end{pmatrix} \begin{pmatrix} z \\ t \end{pmatrix} = \begin{pmatrix} \frac{1}{\sqrt{1-\beta^2}} & -\frac{\beta}{\sqrt{1-\beta^2}} \\ -\frac{\beta}{\sqrt{1-\beta^2}} & \frac{1}{\sqrt{1-\beta^2}} \end{pmatrix} \begin{pmatrix} z \\ t \end{pmatrix}$$

Compare:

$$\gamma^2 - \gamma^2\beta^2 = \frac{1}{1-\beta^2} - \frac{\beta^2}{1-\beta^2} = 1 \Leftrightarrow \cosh^2 y - \sinh^2 y = 1$$

$$\rightarrow \begin{cases} \gamma = \cosh y \\ \beta\gamma = \sinh y \end{cases} \rightarrow \beta = \tanh y, \quad y \text{ rapidity}$$

$$\rightarrow \begin{pmatrix} z' \\ t' \end{pmatrix} = \begin{pmatrix} \cosh y & -\sinh y \\ -\sinh y & \cosh y \end{pmatrix} \begin{pmatrix} z \\ t \end{pmatrix}$$

→ Another way of writing a Lorentz transformation: y instead of β, γ

Collider Kinematics - IV

Split off longitudinal/transverse momentum components:

$$E^2 = m^2 + |\mathbf{p}|^2$$

$$|\mathbf{p}|^2 = p_{\parallel}^2 + p_{\perp}^2$$

$$\rightarrow E^2 = m^2 + p_{\parallel}^2 + p_{\perp}^2 = m_{\perp}^2 + p_{\parallel}^2, \quad m_{\perp}^2 = m^2 + p_{\perp}^2 \quad \text{transverse mass}$$

$$\rightarrow \left(\frac{E}{m_{\perp}}\right)^2 - \left(\frac{p_{\parallel}}{m_{\perp}}\right)^2 = 1$$

$$\rightarrow \begin{cases} E = m_{\perp} \cosh y \\ p_{\parallel} = m_{\perp} \sinh y \end{cases}$$

$$\rightarrow p_{\parallel} = E \tanh y$$

$$\rightarrow \begin{pmatrix} p_{\parallel}' \\ E' \end{pmatrix} = \begin{pmatrix} \cosh y & -\sinh y \\ -\sinh y & \cosh y \end{pmatrix} \begin{pmatrix} p_{\parallel} \\ E \end{pmatrix}$$

Collider Kinematics - V

Most important properties:

Rapidity is *additive* under Lorentz boosts

Transverse momentum is *invariant* under Lorentz boosts

$$\begin{cases} E = m_{\perp} \cosh y \\ p_{\parallel} = m_{\perp} \sinh y \end{cases} \rightarrow \frac{p_{\parallel}}{E} = \tanh y = \frac{e^y - e^{-y}}{e^y + e^{-y}} = \frac{e^{2y} - 1}{e^{2y} + 1}$$

$$\rightarrow \frac{p_{\parallel}}{E} (e^{2y} + 1) = e^{2y} - 1 \rightarrow e^{2y} \left(\frac{p_{\parallel}}{E} - 1 \right) = - \left(1 + \frac{p_{\parallel}}{E} \right) \rightarrow e^{2y} = \frac{1 + \frac{p_{\parallel}}{E}}{1 - \frac{p_{\parallel}}{E}}$$

$$\rightarrow y = \frac{1}{2} \ln \frac{E + p_{\parallel}}{E - p_{\parallel}}$$

Boost along z by β, γ

$$\rightarrow y' = \frac{1}{2} \ln \frac{\gamma(E + \beta p_{\parallel}) + \gamma(p_{\parallel} + \beta E)}{\gamma(E + \beta p_{\parallel}) - \gamma(p_{\parallel} + \beta E)}$$

Collider Kinematics - VI

$$\rightarrow y' = \frac{1}{2} \ln \frac{(E + p_{\parallel})(1 + \beta)}{(E - p_{\parallel})(1 - \beta)} = \underbrace{\frac{1}{2} \ln \frac{(E + p_{\parallel})}{(E - p_{\parallel})}}_y + \underbrace{\frac{1}{2} \ln \frac{(1 + \beta)}{(1 - \beta)}}_{y_{boost}}$$

Indeed:

$$y \rightarrow y' = y + y_{boost}$$

$$\rightarrow dy' = dy, \quad \Delta y' = \Delta y$$

Consistency check:

For momentum along z

$$y = \frac{1}{2} \ln \frac{E + p}{E - p} = \frac{1}{2} \ln \frac{\gamma m + \beta \gamma m}{\gamma m - \beta \gamma m} = \frac{1}{2} \ln \frac{1 + \beta}{1 - \beta}$$

$$\rightarrow \frac{1 + \beta}{1 - \beta} = e^{2y} \rightarrow 1 + \beta = (1 - \beta) e^{2y} \rightarrow \beta(1 + e^{2y}) = e^{2y} - 1$$

$$\rightarrow \beta = \frac{e^{2y} - 1}{e^{2y} + 1} = \tanh y$$

$$\rightarrow \gamma = \cosh y \rightarrow \text{OK}$$

Collider Kinematics - VII

Pseudo-rapidity η :

$$y = \frac{1}{2} \ln \frac{E + p_{\parallel}}{E - p_{\parallel}} \approx \frac{1}{2} \ln \frac{1 + \cos \theta}{1 - \cos \theta} = -\frac{1}{2} \ln \frac{1 - \cos \theta}{1 + \cos \theta} = -\frac{1}{2} \ln \frac{\sin^2 \theta/2}{\cos^2 \theta/2}$$

$$\rightarrow y \approx -\frac{1}{2} \ln(\tan^2 \theta/2) = -\ln(\tan \theta/2) = \eta$$

1 – to –1 correspondance to polar angle

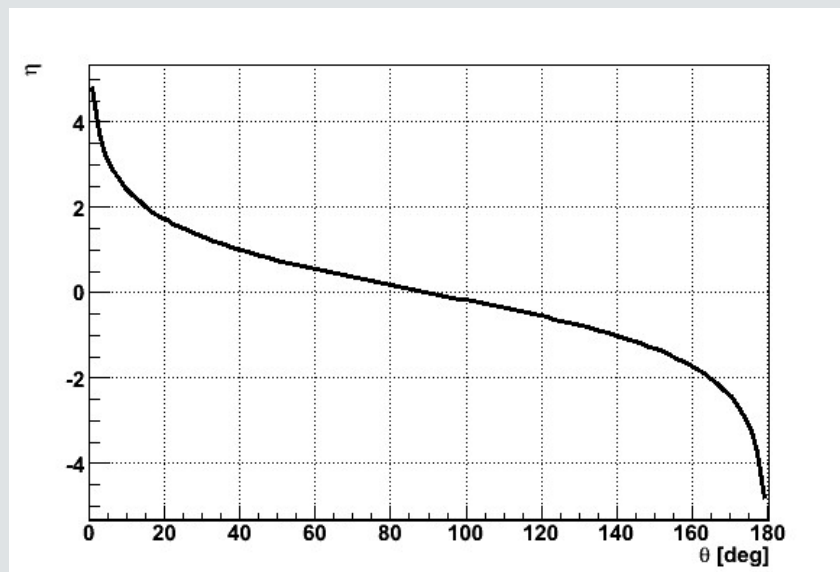

Collider Kinematics - VIII

Second issue with hadron colliders :

(Very) Large number of final particles

→ *Exclusive* (= full) description of process not practical/possible/interesting

Interesting processes: *Inclusive*

Ex: Inclusive production of c $a + b \rightarrow c + X$

→ Inclusive, invariant cross-sections

Reminder: $\frac{d^3\mathbf{P}}{E}$ Lorentz invariant quantity

Elementary volume (impulse space): Same as cylindrical coordinate space

$$d^3\mathbf{r} = r dr dz d\varphi \rightarrow d^3\mathbf{P} = P_T dP_T dP_{\parallel} d\varphi \rightarrow \frac{d^3\mathbf{P}}{E} = \frac{P_T dP_T dP_{\parallel} d\varphi}{E}$$

$$dy = \frac{dP_{\parallel}}{E} \rightarrow \frac{d^3\mathbf{P}}{E} = dy P_T dP_T d\varphi$$

$$\int_{\varphi=0}^{\varphi=2\pi} \frac{d^3\mathbf{P}}{E} = \int_{\varphi=0}^{\varphi=2\pi} (dy P_T dP_T) d\varphi = 2\pi dy P_T dP_T = 2\pi dy \frac{1}{2} d(P_T^2) = \pi dy d(P_T^2)$$

→ Inclusive, invariant differential cross-section:

$$\frac{d\sigma}{\frac{d^3\mathbf{P}}{E}} = E \frac{d\sigma}{d^3\mathbf{P}} = \frac{1}{\pi} \frac{d\sigma}{dy d(P_T^2)} \equiv \frac{1}{2\pi P_T} \frac{d\sigma}{dy dP_T}$$

Collider Kinematics - IX

Introducing pseudorapidity, transverse energy components of 4-momentum:

$$E_T = m_{\perp} \rightarrow \begin{matrix} E = E_T \cosh y \\ p_{\parallel} = E_T \sinh y \end{matrix} \rightarrow E_T = \frac{E}{\cosh y}, \quad y \approx \eta = -\ln(\tan \theta/2)$$

$$\frac{\sinh y}{\cosh y} = \tanh y = \frac{\sqrt{\cosh^2 y - 1}}{\cosh y}$$

$$\rightarrow \tanh^2 y = 1 - \frac{1}{\cosh^2 y} \rightarrow \frac{1}{\cosh y} = \sqrt{1 - \tanh^2 y} \rightarrow E_T = E \sqrt{1 - \tanh^2 y}$$

$$\rightarrow E_T \approx E \sqrt{1 - \tanh^2 \eta} = E \left(1 - \frac{\frac{\cos \theta/2}{\sin \theta/2} - \frac{\sin \theta/2}{\cos \theta/2}}{\frac{\cos \theta/2}{\sin \theta/2} + \frac{\sin \theta/2}{\cos \theta/2}} \right)^{1/2} = E \left[1 - (\cos^2 \theta/2 - \sin^2 \theta/2) \right]^{1/2} = E \sin \theta$$

$$p = \left(E, \underbrace{P_x, P_y}_{P_T^2 = P_x^2 + P_y^2}, \underbrace{P_z}_{P_{\parallel} = P_z} \right)$$

$$E \approx P, E_T \approx P_T$$

$$\rightarrow p \approx \left(E_T \cosh \eta, \underbrace{E_T \sin \phi, E_T \cos \phi}_{E_T}, E_T \sinh \eta \right) \quad \text{Useful in clustering algorithms}$$

Collider Kinematics - X

Partonic kinematics: Relevant for 'hard' collisions

Event CM frame:

$$\begin{cases} P_A = (E_A, 0, 0, p_A) \\ P_B = (E_A, 0, 0, -p_A) \end{cases} \quad \text{4-momenta incident particles}$$

$$\begin{cases} p_1 = x_1 P_A \\ p_2 = x_2 P_B \end{cases} \quad \text{4-momenta incident partons}$$

$$\beta_{CM} = \frac{x_1 - x_2}{x_1 + x_2} \quad \text{Parton CM speed as seen by event CM (= LAB for most colliders)}$$

$$x_F = x_1 - x_2 \quad \text{Parton Feynman } x$$

$$y = \frac{1}{2} \ln \frac{1 + \beta_{CM}}{1 - \beta_{CM}} = \frac{1}{2} \ln \frac{x_1}{x_2} \quad \text{Parton CM rapidity as seen by event CM}$$

x_1, x_2 varying on event-by-event basis

$\rightarrow \beta_{CM}, x_F, y$ not fixed, rather statistically distributed

Distribution depending on event type

Collider Kinematics - XI

Hadronic, inclusive cross sections for hard processes

$$A + B \rightarrow c + X$$

result from a convolution of *partonic, exclusive* cross sections

$$a + b \rightarrow c + X$$

at any given partonic CM energy \hat{s}

$$\sigma_{A+B \rightarrow f+X} = \sum_{a,b} C_{ab} \int \sigma_{ab \rightarrow c+X} \left[f_{a/A}(x_a) f_{b/B}(x_b) + (A \leftrightarrow B)_{b \neq a} \right] dx_a dx_b$$

with PDF over full range of (x_1, x_2)

$$\sigma_{ab \rightarrow c+X} \left\{ \begin{array}{l} \text{total/differential in the final state } c \\ \text{summed over initial, final colors} \end{array} \right.$$

C_{ab} color-averaging factor, different for qq , $q\bar{q}$, qg , gg

Collider Kinematics - XII

Partonic CM energy :

$$\sqrt{\hat{s}} = \sqrt{s x_a x_b}$$

Introduce τ :

$$\tau = x_a x_b$$

Switching to x_a, τ independent variables:

$$x_b = \frac{\tau}{x_a} \rightarrow dx_b = \frac{d\tau}{x_a}$$

→ Hadronic cross-section in terms of partonic subprocess contributions:

$$\sigma_{A+B \rightarrow f+X} = \sum_{a,b} C_{ab} \int_0^1 d\tau \int_{\tau}^1 \sigma_{ab \rightarrow c+X}(\hat{s}) \left[f_{a/A}(x_a) f_{b/B}(\tau/x_a) + (A \leftrightarrow B)_{b \neq a} \right] \frac{dx_a}{x_a}$$

Collider Kinematics - XIII

→ Re-write cross-section as *differential* in τ :

$$d\sigma_{A+B \rightarrow f+X} = \sum_{a,b} \sigma_{ab \rightarrow c+X}(\hat{s}) \underbrace{C_{ab} \int_{\tau}^1 \left[f_{a/A}(x_a) f_{b/B}(\tau/x_a) + (A \leftrightarrow B)_{b \neq a} \right] \frac{dx_a}{x_a}}_{\frac{dL_{ab}}{d\tau}} d\tau$$

Introducing *differential luminosity* for parton collisions occurring within $(\tau, \tau + d\tau)$:

$$\frac{dL_{ab}}{d\tau} = C_{ab} \int_{\tau}^1 \left[f_{a/A}(x_a) f_{b/B}(\tau/x_a) + (A \leftrightarrow B)_{b \neq a} \right] \frac{dx_a}{x_a}$$

$$\rightarrow \frac{d\sigma_{A+B \rightarrow f+X}}{d\tau} = \sum_{a,b} \sigma_{ab \rightarrow c+X}(\hat{s}) \frac{dL_{ab}}{d\tau}$$

$$\text{Observe: } \frac{\tau}{\hat{s}} \frac{dL_{ab}}{d\tau} = \frac{1}{s} \frac{dL_{ab}}{d\tau} = \frac{dL_{ab}}{d\hat{s}}$$

Parton luminosities quite relevant to assess production rates:

Ex. Higgs at LHC

Collider Kinematics - XIV

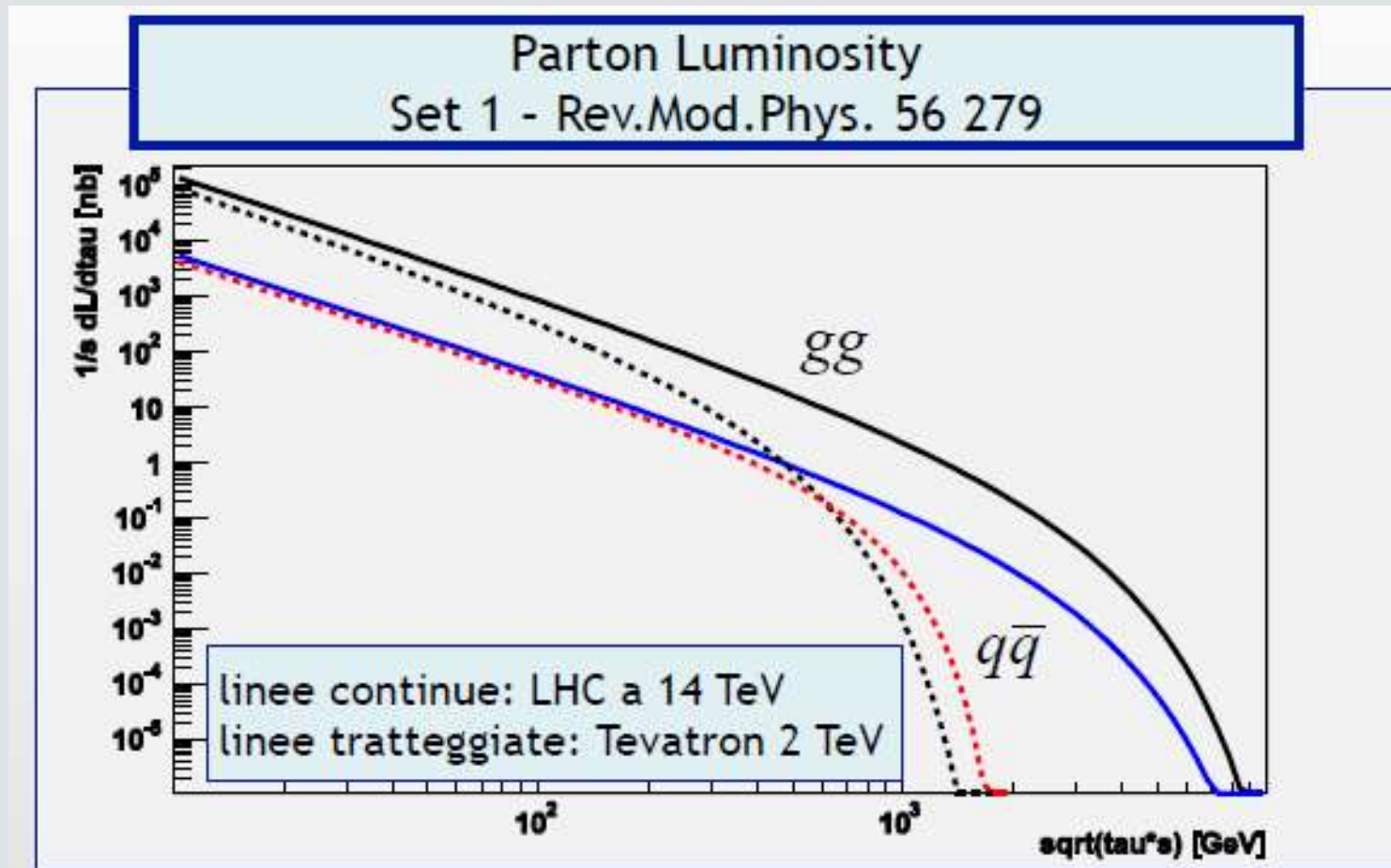

Collider Kinematics - XV

τ alone does not fix kinematics of the initial state: Use y Rapidity

$$\begin{cases} \tau = x_a x_b \\ y = \frac{1}{2} \ln \frac{x_a}{x_b} \end{cases} \rightarrow \begin{cases} x_a = \sqrt{\tau} e^y \\ x_b = \sqrt{\tau} e^{-y} \end{cases} \rightarrow \sqrt{\hat{s}} \equiv \sqrt{\tau s}, \quad dx_1 dx_2 = d\tau dy$$

For any given τ : $|y| < -\frac{1}{2} \ln \tau$

Re-write hadronic cross-section as *doubly differential* in both y, τ :

$$\frac{d\sigma_{A+B \rightarrow c+X}}{dx_a dx_b} = \sum_{a,b} C_{ab} \sigma_{ab \rightarrow c+X} \left[f_{a/A}(x_a) f_{b/B}(x_b) + (A \leftrightarrow B)_{b \neq a} \right] = \frac{d\sigma}{d\tau dy}$$

Ex. : *Central production*:

$$y = 0 \rightarrow x_a = x_b = \sqrt{\tau} \rightarrow \left. \frac{d\sigma}{d\tau dy} \right|_{y=0} = \sum_{a,b} C_{ab} \sigma_{ab \rightarrow c+X} \left[f_{a/A}(\sqrt{\tau}) f_{b/B}(\sqrt{\tau}) + (A \leftrightarrow B)_{b \neq a} \right]$$

Ex. : *Threshold production*

$$\sqrt{\tau} = \frac{m_c}{\sqrt{s}}$$

Collider Kinematics - XVI

Examples of rapidity distribution: Threshold $t\bar{t}$, $b\bar{b}$ production at Tevatron, LHC

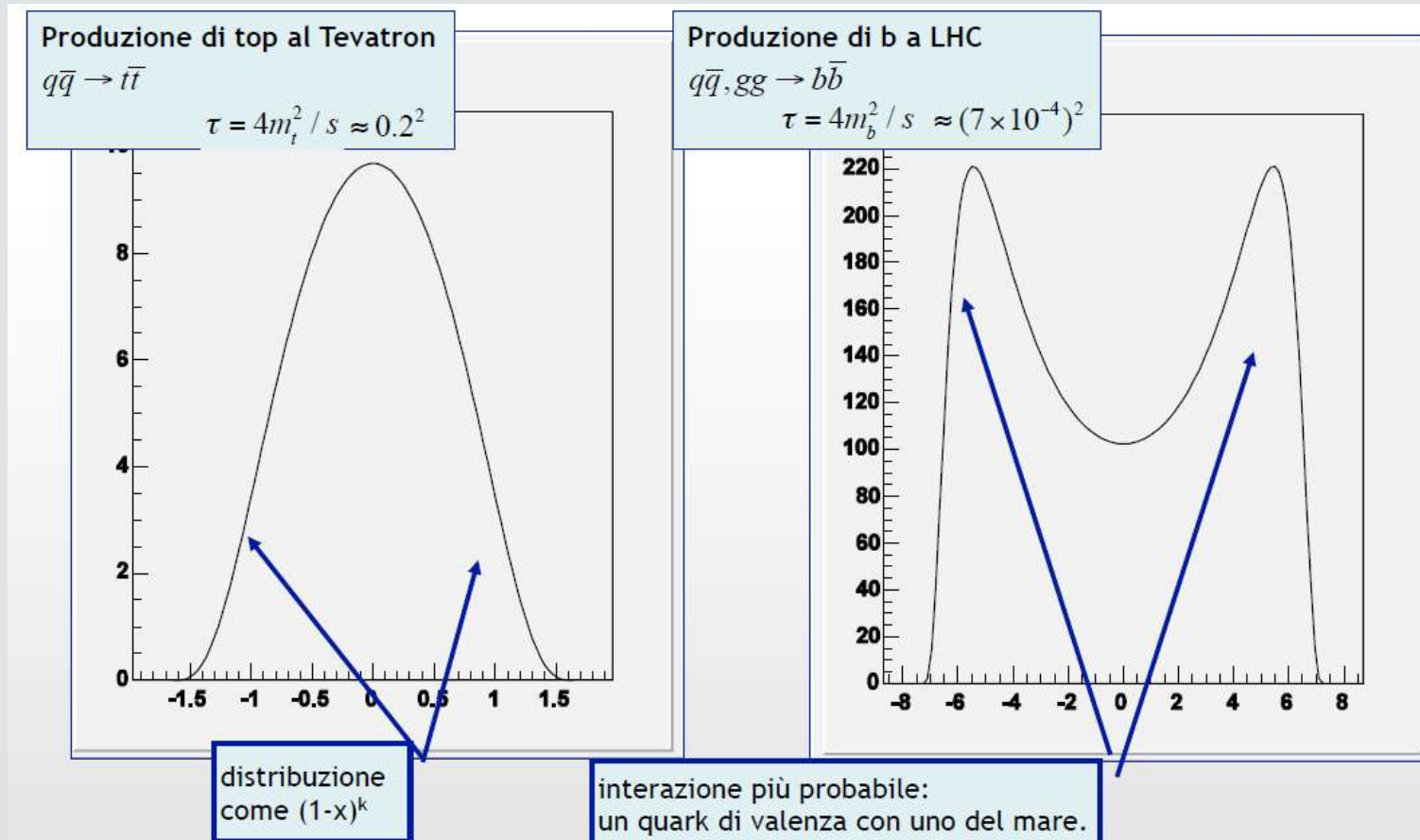

PQCD: Drell-Yan - I

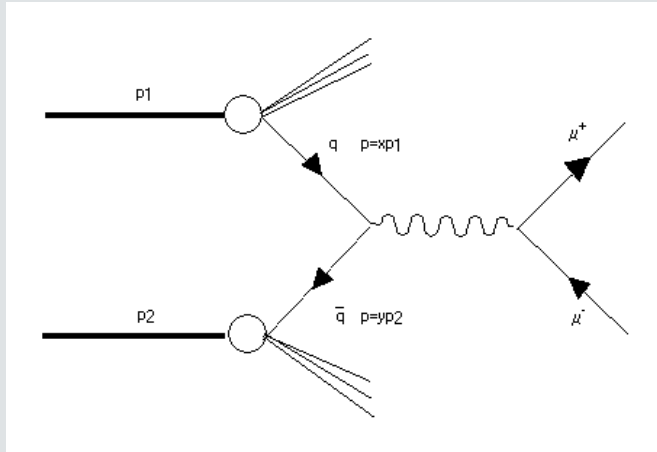

$$\frac{d\sigma(q\bar{q} \rightarrow l^+l^-)}{dq^2} = \frac{4\pi\alpha^2}{3q^2} e_q^2 \delta(q^2 - s_{q\bar{q}})$$

x_1, x_2 Bjorken x for q, \bar{q}

$$s_{q\bar{q}} = (p_q + p_{\bar{q}})^2 = (x_1 p_1 + x_2 p_2)^2 \simeq x_1 x_2 s$$

$$\sigma(q\bar{q} \rightarrow l^+l^-) = \frac{4\pi\alpha^2}{3q^2} e_q^2, \quad e_q = \text{quark charge in } e \text{ units}$$

$$s_{q\bar{q}} = M_{\mu\mu}^2 = \tau s$$

Parton model: Pure QED process

PQCD: Drell – Yan - II

Reverse $e^+e^- \rightarrow q\bar{q}$ process: $q\bar{q} \rightarrow e^+e^-$

Obtained by any reaction

hadron + hadron $\rightarrow l^+ l^- + X$

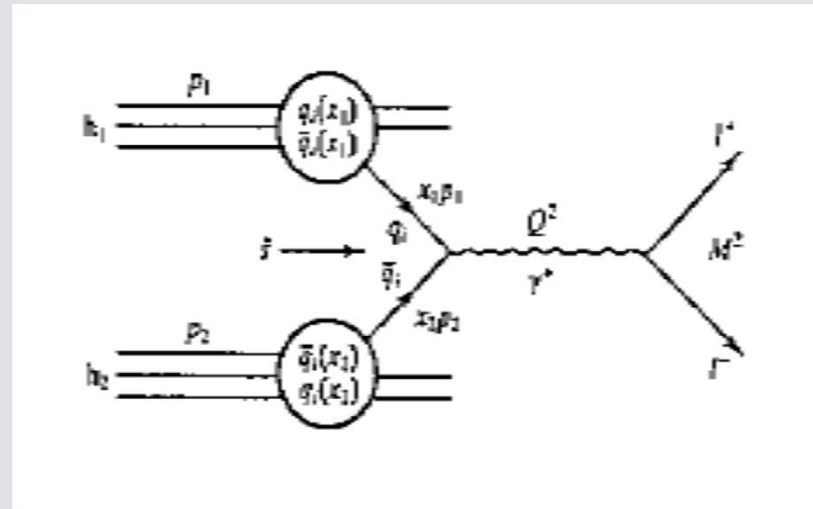

Ignore parton transverse momentum

Ignore non-annihilating partons (\rightarrow "spectators")

Ignore parton fragmentation

PQCD: Drell – Yan - III

$$e^+e^- \rightarrow \mu^+\mu^- :$$

$$\frac{d\sigma}{d\Omega^*} = \frac{\alpha^2}{4s} (1 + \cos^2 \theta^*)$$

$$\sigma = \frac{4\pi\alpha^2}{3s}$$

$$q\bar{q} \rightarrow \mu^+\mu^- :$$

$$\frac{d\sigma_q}{d\Omega^*} = \frac{Q_q^2\alpha^2}{4M^2} (1 + \cos^2 \theta^*) \cdot \frac{1}{3}$$

$Q_q e$: Quark charge

$\frac{1}{3}$: Color factor

M^2 : $\mu^+\mu^-$ invariant mass = Total energy in partonic CM

PQCD: Drell – Yan - IV

Angular distribution in the pair rest frame

Expect $\propto 1 + \cos^2 \theta^*$ as usual for Fermion-Antifermion

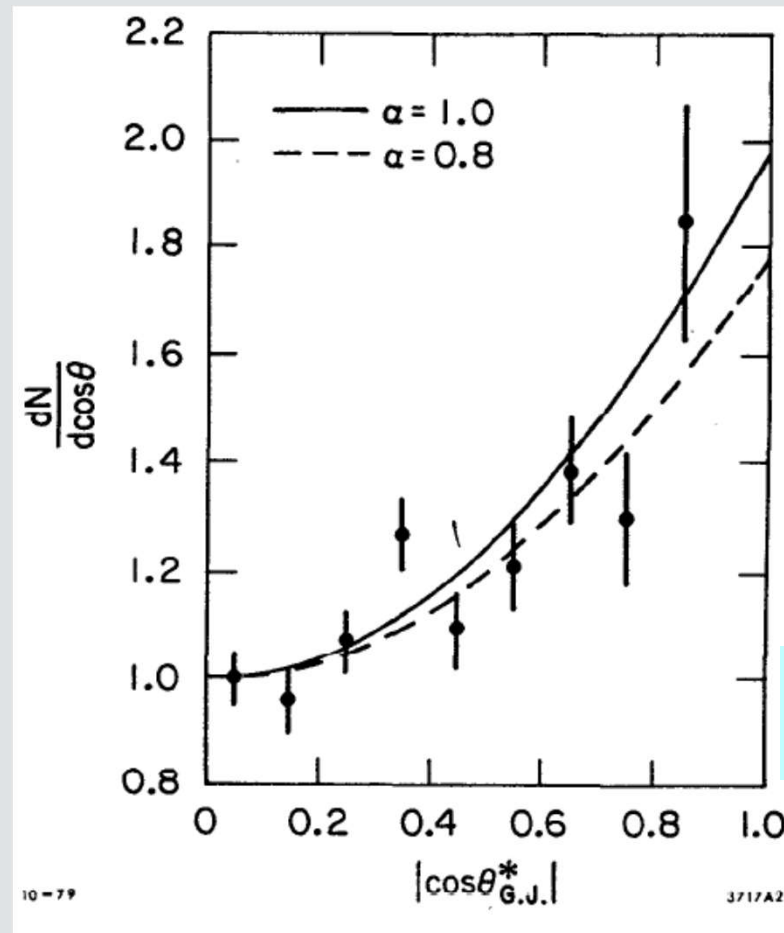

PQCD: Drell – Yan - V

$$p_1 = x_1 P_1 \simeq x_1 (E, 0, 0, P)$$

$$p_2 = x_2 P_2 \simeq x_2 (E, 0, 0, -P)$$

$$q = x_1 P_1 + x_2 P_2 \simeq [(x_1 + x_2)E, 0, 0, (x_1 - x_2)P]$$

$$M^2 = q^2 \simeq (x_1 + x_2)^2 E^2 - (x_1 - x_2)^2 P^2 \simeq 4x_1 x_2 E^2 = x_1 x_2 s \equiv \tau s$$

Switch to more useful kinematical variables:

Either

$$\begin{cases} x_F \equiv x_1 - x_2 = \pm \frac{2|\mathbf{q}|}{\sqrt{s}} & \text{Feynman } x \text{ of parton pair} \\ M^2 = s x_1 x_2 \end{cases}$$

Or:

$$\begin{cases} y = \frac{1}{2} \ln \frac{E + p_3}{E - p_3} \simeq \frac{1}{2} \ln \frac{x_1}{x_2} & \text{Rapidity of parton pair (neglecting rest mass)} \\ M = \sqrt{s x_1 x_2} \end{cases}$$

PQCD: Drell – Yan - VI

Inclusive cross-section:

Contribution by parton pair with (x_1, x_2) fractional momenta

$$d^2\sigma(pp \rightarrow \mu^+\mu^- + X) = \frac{4\pi\alpha^2}{9M^2} \sum_q Q_q^2 [f_q(x_1)f_{\bar{q}}(x_2) + f_q(x_2)f_{\bar{q}}(x_1)] dx_1 dx_2$$

$$\begin{cases} y = \frac{1}{2} \ln \frac{E + p_3}{E - p_3} \simeq \frac{1}{2} \ln \frac{x_1}{x_2} \rightarrow x_1 = x_2 e^{2y} \\ M = \sqrt{s x_1 x_2} \rightarrow M = \sqrt{s x_2 e^{2y}} \rightarrow x_2 = \frac{M}{\sqrt{s}} e^{-y}, x_1 = \frac{M}{\sqrt{s}} e^{+y} \end{cases}$$

$$dx_1 dx_2 = J dM dy$$

$$J = \frac{\partial(x_1, x_2)}{\partial(M, y)} = \begin{vmatrix} \frac{\partial x_1}{\partial M} & \frac{\partial x_1}{\partial y} \\ \frac{\partial x_2}{\partial M} & \frac{\partial x_2}{\partial y} \end{vmatrix} = \frac{\partial x_1}{\partial M} \frac{\partial x_2}{\partial y} - \frac{\partial x_1}{\partial y} \frac{\partial x_2}{\partial M}$$

$$\rightarrow J = \frac{1}{\sqrt{s}} e^{+y} \left(-\frac{M}{\sqrt{s}} e^{-y} \right) - \frac{M}{\sqrt{s}} e^{+y} \frac{1}{\sqrt{s}} e^{-y} = -\frac{2M}{s} = -2\sqrt{\frac{x_1 x_2}{s}} \rightarrow dx_1 dx_2 = \left(-2\sqrt{\frac{x_1 x_2}{s}} \right) dM dy$$

PQCD: Drell – Yan - VII

$$\rightarrow d^2\sigma = \frac{4\pi\alpha^2}{9M^2} \left| -2\sqrt{\frac{x_1 x_2}{s}} \right| \sum_q Q_q^2 [f_q(x_1) f_{\bar{q}}(x_2) + f_q(x_2) f_{\bar{q}}(x_1)] dM dy$$

$$s\tau = M^2 \rightarrow M = \sqrt{s\tau}$$

$$\rightarrow \frac{d^2\sigma}{dM dy} = \frac{8\pi\alpha^2}{9M^2} \frac{\tau}{M} \sum_q Q_q^2 [f_q(x_1) f_{\bar{q}}(x_2) + f_q(x_2) f_{\bar{q}}(x_1)]$$

$$\rightarrow \frac{d^2\sigma}{dM dy} = \frac{8\pi\alpha^2}{9Ms} \sum_q Q_q^2 [f_q(x_1) f_{\bar{q}}(x_2) + f_q(x_2) f_{\bar{q}}(x_1)]$$

Central events:

$$y = 0, x_1 = x_2 = \sqrt{\tau}$$

$$\rightarrow \left. \frac{d^2\sigma}{dM dy} \right|_{y=0} = \frac{8\pi\alpha^2}{9Ms} \sum_q Q_q^2 [f_q(\sqrt{\tau}) f_{\bar{q}}(\sqrt{\tau}) + f_q(\sqrt{\tau}) f_{\bar{q}}(\sqrt{\tau})]$$

$$\rightarrow s^{3/2} \left. \frac{d^2\sigma}{dM dy} \right|_{y=0} = \frac{8\pi\alpha^2}{9} \frac{1}{\sqrt{\tau}} \sum_q Q_q^2 [f_q(\sqrt{\tau}) f_{\bar{q}}(\sqrt{\tau}) + f_q(\sqrt{\tau}) f_{\bar{q}}(\sqrt{\tau})]$$

PQCD: Drell – Yan - VIII

$$M = \sqrt{s\tau} \rightarrow dM = \sqrt{s}d(\sqrt{\tau})$$

$$\rightarrow s^{3/2} \frac{d^2\sigma}{dMdy} \Big|_{y=0} = s^{3/2} \frac{d^2\sigma}{\sqrt{s}d(\sqrt{\tau})dy} \Big|_{y=0} = s \frac{d^2\sigma}{d(\sqrt{\tau})dy} \Big|_{y=0}$$

$$\rightarrow s \frac{d^2\sigma}{d(\sqrt{\tau})dy} \Big|_{y=0} = \frac{8\pi\alpha^2}{9} \frac{1}{\sqrt{\tau}} \sum_q Q_q^2 [f_q(\sqrt{\tau})f_{\bar{q}}(\sqrt{\tau}) + f_{\bar{q}}(\sqrt{\tau})f_q(\sqrt{\tau})]$$

Scaling behavior: Compare to DIS

PQCD: Drell – Yan - IX

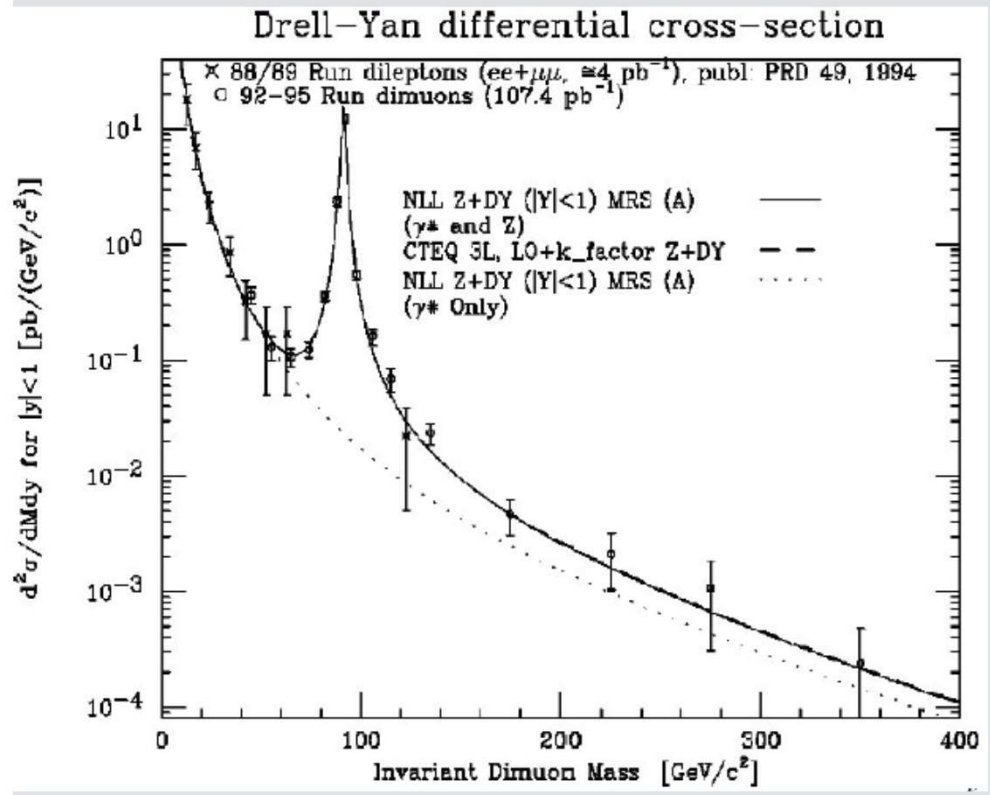
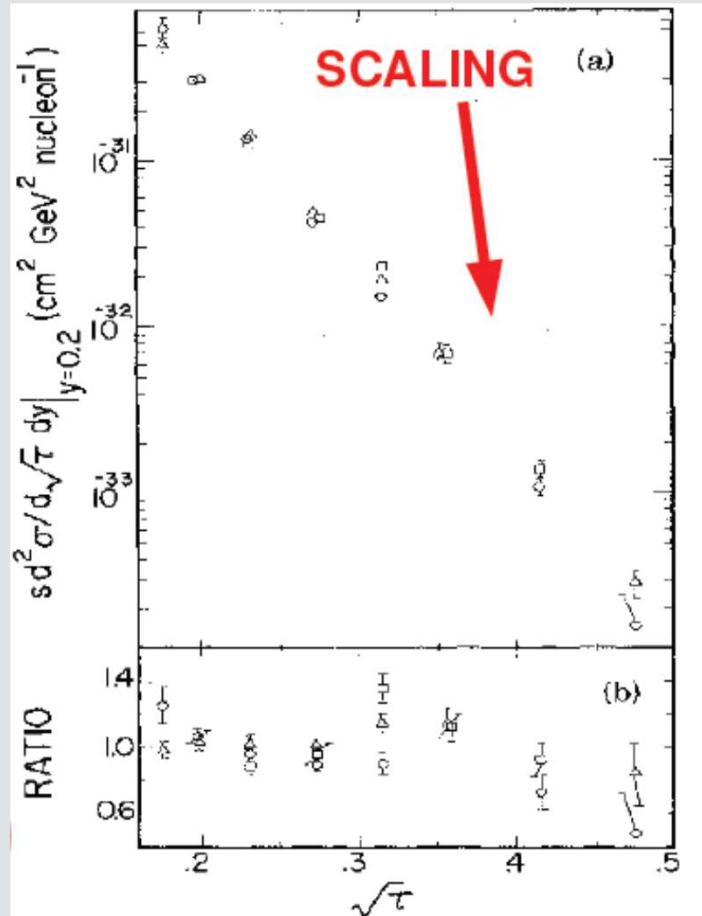

PQCD: Drell – Yan - X

NLO QCD corrections:

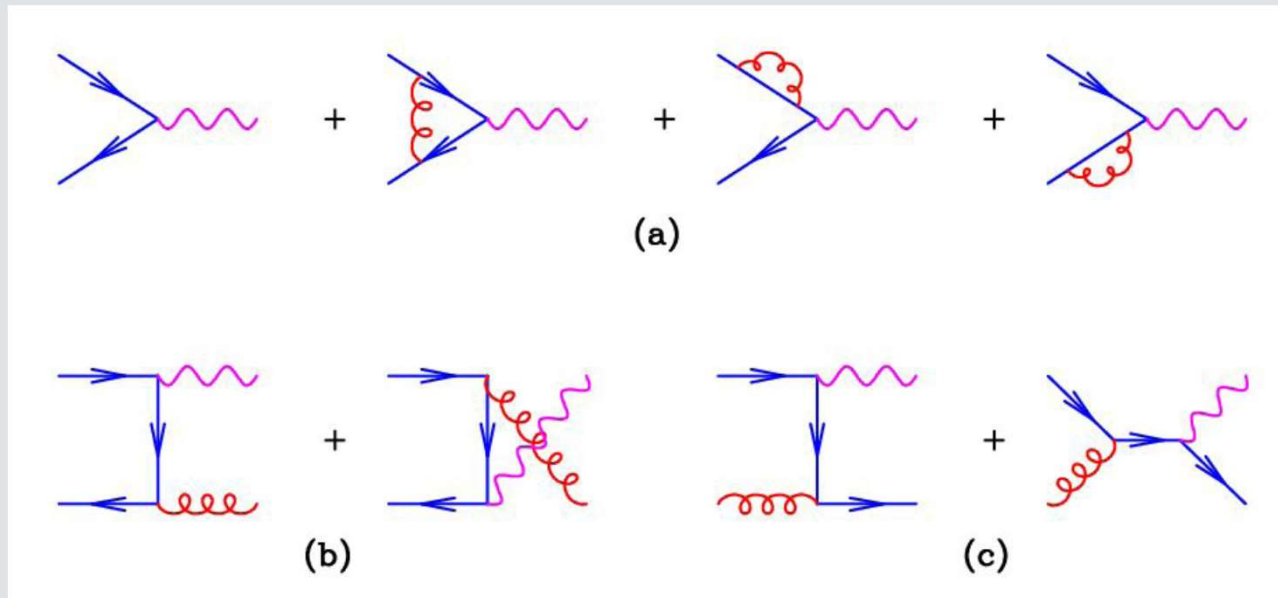

Quite similar to QCD corrections to:

$$e^+e^- \rightarrow q\bar{q}$$

PQCD: Drell – Yan - XI

Total rate:

Same effect as for

$$e^+e^- \rightarrow q\bar{q}$$

Real gluons compensate virtual gluons

$$\sigma(\text{real}) + \sigma(\text{virtual}) = \frac{2\alpha_s}{3\pi} \sigma_0 \left(\frac{4\pi^2}{3} - \frac{7}{2} \right)$$

→ Overall effect lumped into a K -factor

$$K_{DY}^{(1)} = 1 + \frac{\alpha_s}{\pi} \left(\frac{8\pi^2}{9} - \frac{7}{3} \right) \approx 1 + 2.05\alpha_s \sim 2$$

→ QCD predicting a sizeable enhancement of total cross-section by a factor ~ 2

PQCD: Drell – Yan - XII

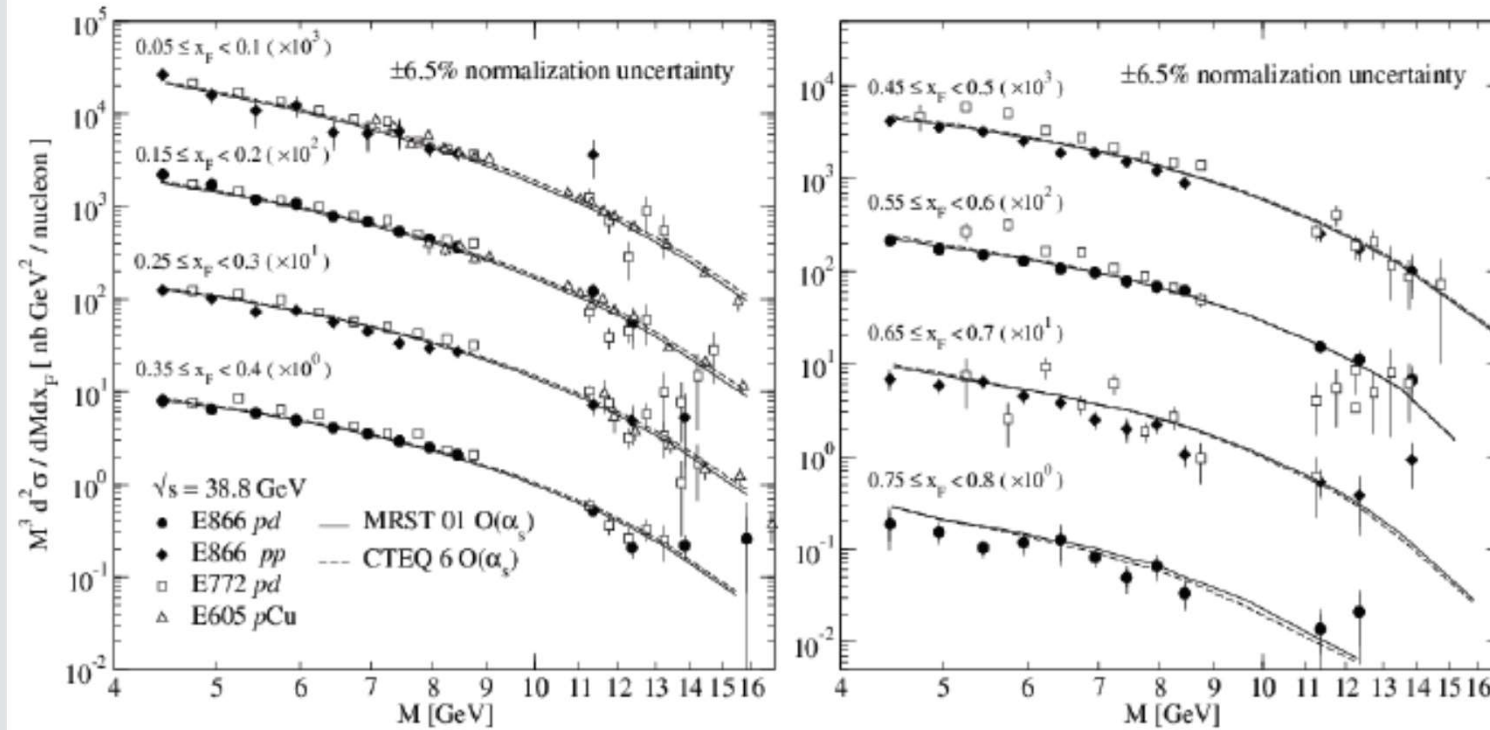

Extracting same PDFs as from DIS : Good check

Also extract PDFs for mesons

PQCD: Drell – Yan - XIII

Basic diagram generalized to include electroweak extensions:

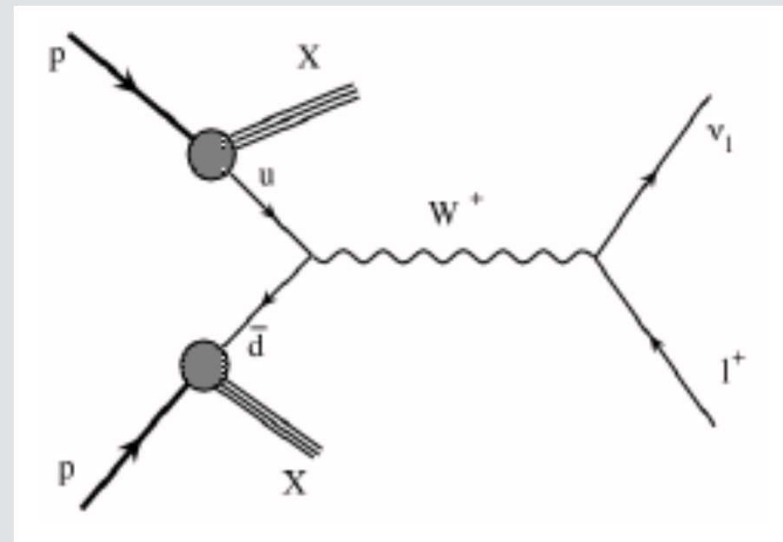
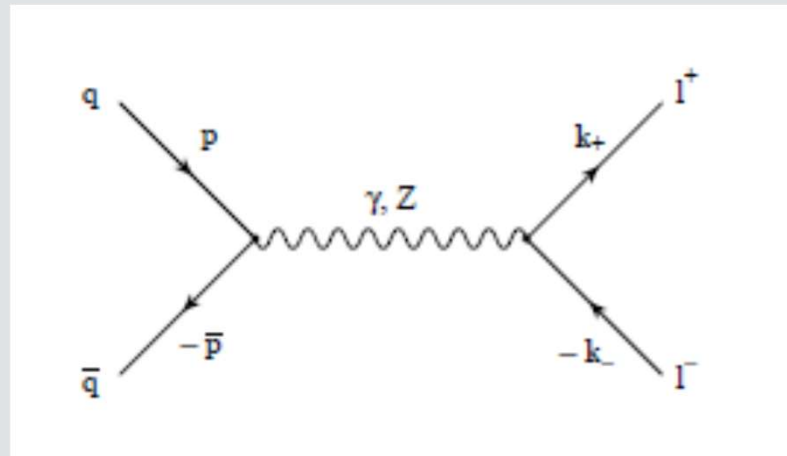

Quite important processes at hadron colliders

PQCD: Drell – Yan - XIV

Drell-Yan at large: LHC

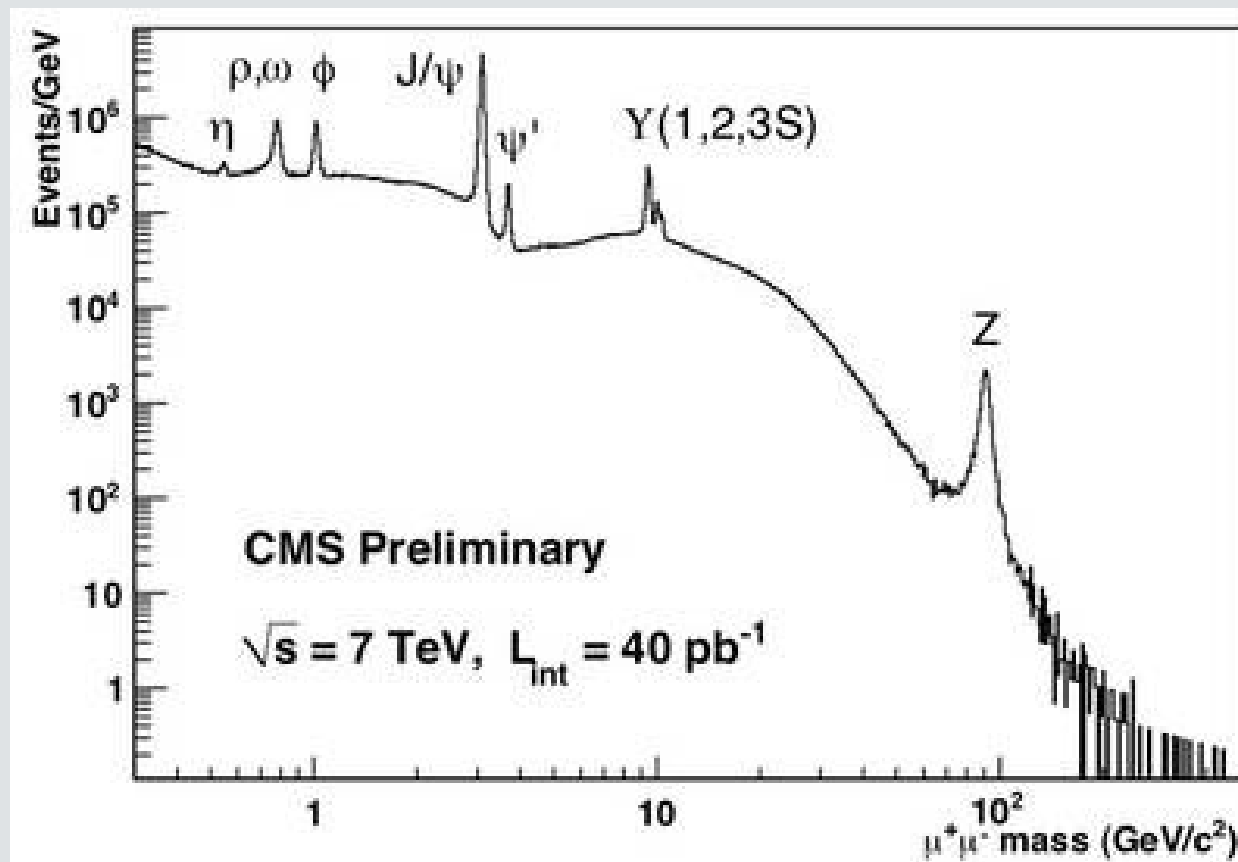

PQCD: Hadron Collisions - I

Consider all the 2-body processes in QCD:

$$qq \rightarrow qq, q\bar{q} \rightarrow q\bar{q}$$

$$qg \rightarrow qg, \bar{q}g \rightarrow \bar{q}g, gg \rightarrow gg, q\bar{q} \rightarrow gg, gg \rightarrow q\bar{q}$$

Quarks only

Quarks and/or Gluons

All yielding 2 jets to LO

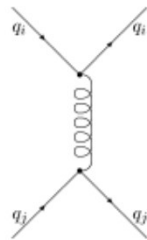

Figure 1: Feynman diagram for $q_i q_j \rightarrow q_i q_j, i \neq j$

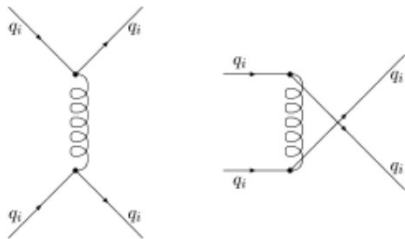

Figure 2: Feynman diagrams for $q_i q_i \rightarrow q_i q_i$

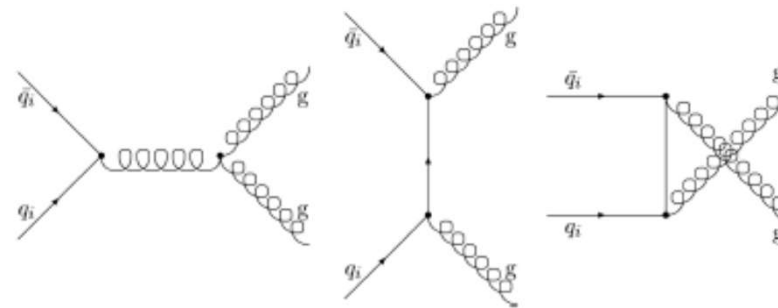

Figure 5: Feynman diagrams for $q_i \bar{q}_i \rightarrow gg$

PQCD: Hadron Collisions - II

When quark - only processes can be identified, expect

$$\frac{d\sigma}{d(\cos\theta^*)} = \frac{\pi\alpha_s^2}{2s_{ij}} |M|^2$$

$$s_{ij} = (x_i p_i + x_j p_j)^2 \approx x_i x_j s$$

$$\rightarrow |M|^2 \propto 1 + \cos^2 \theta^* \text{ as usual}$$

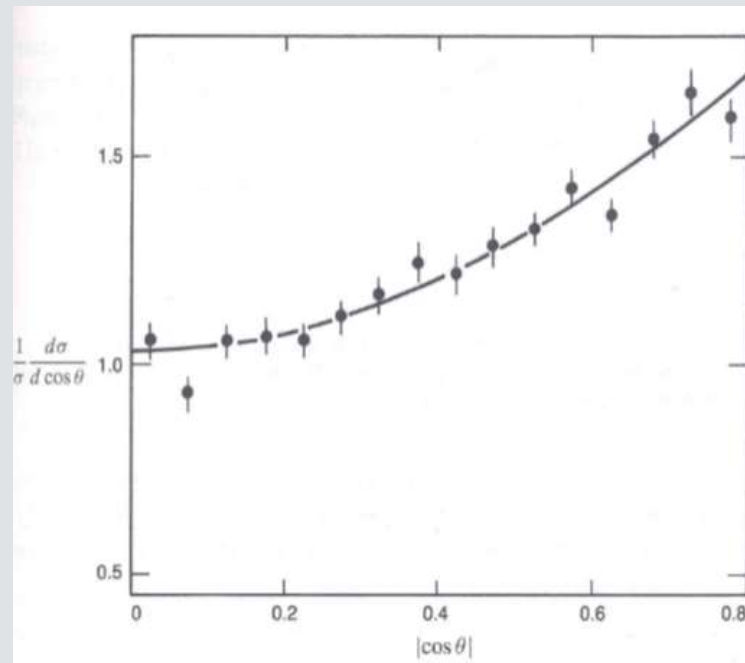

@TBA

PQCD: Hadron Collisions - III

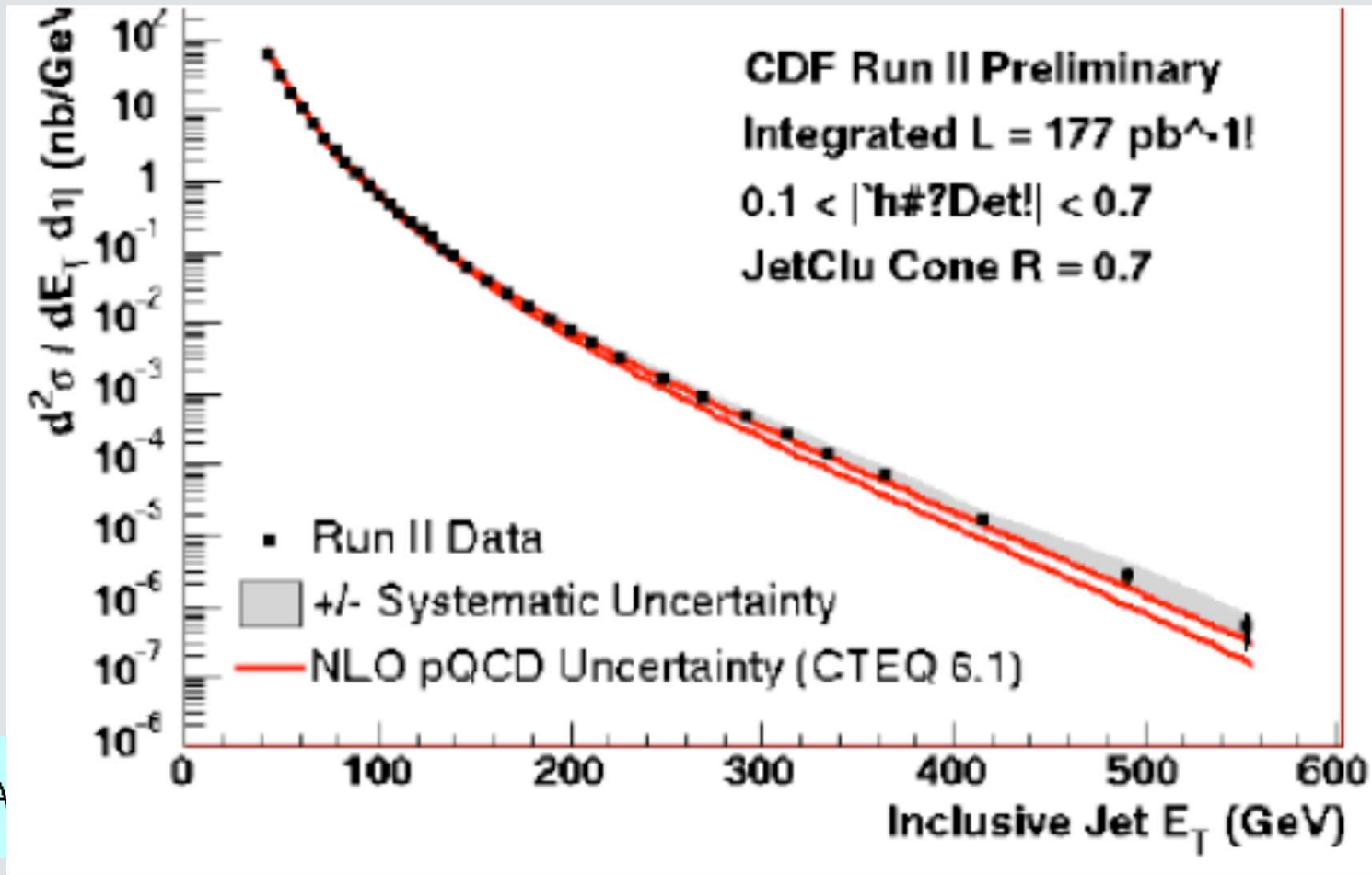

PQCD: Hadron Collisions - IV

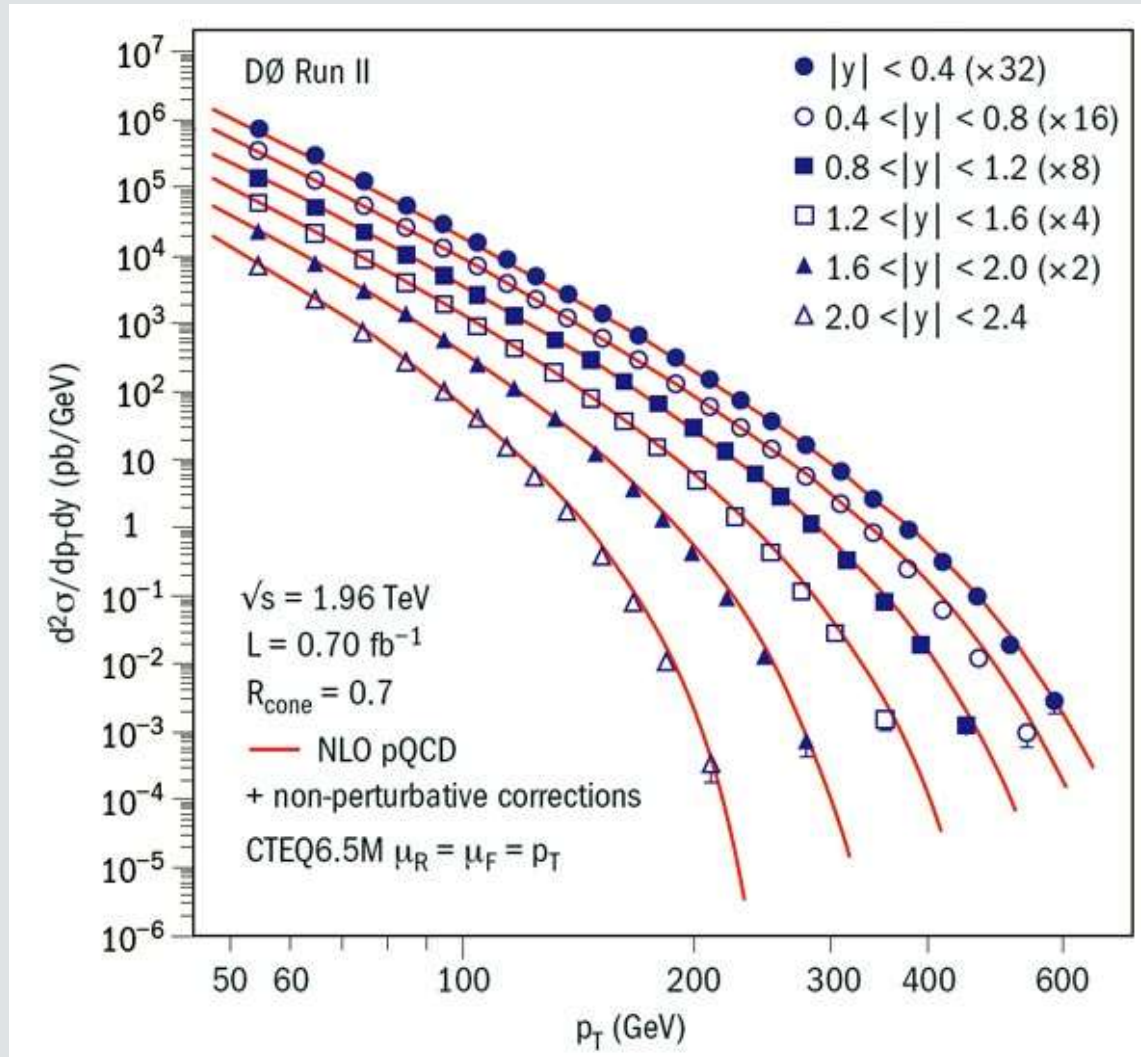

PQCD: Hadron Collisions - V

Complete jet evolution cannot be computed in a full QCD framework:

As shown in the picture, *increasing* time scales correspond to *decreasing* Q^2 scale, down to a region where perturbative expansion cannot be granted

Conversion of quarks and gluons into hadrons (*Fragmentation* or *Hadronization*) must be evaluated by ad-hoc prescriptions (models).

QCD-inspired, successful $q\bar{q}$ models often based on string-like behavior of pairs

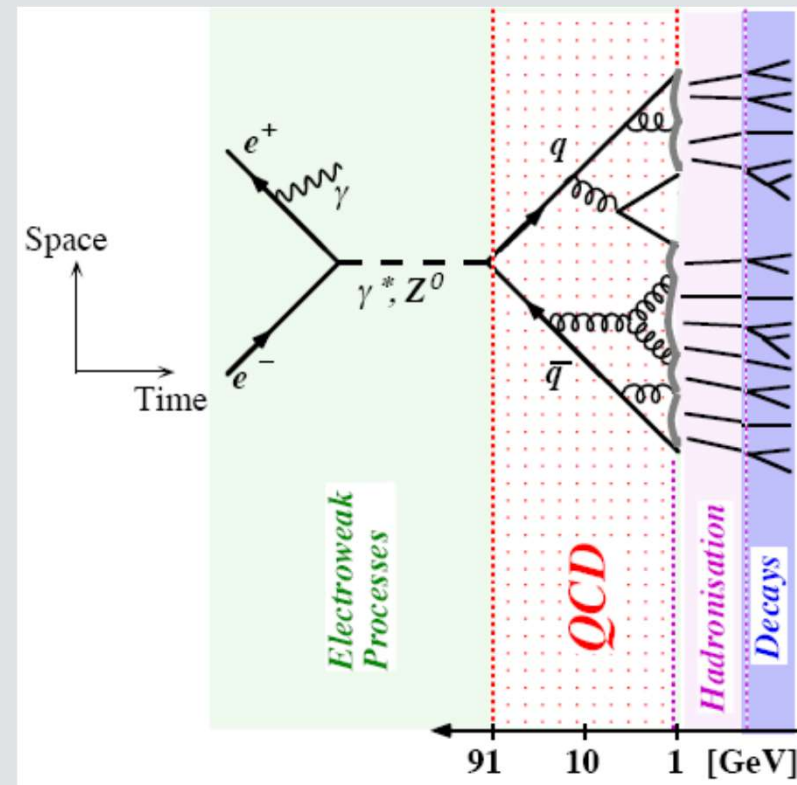

@TBA

PQCD: Hadron Collisions - VI

Typical model implemented in fragmentation Montecarlo programs

$q\bar{q}$ Interaction

QED-like at small distance

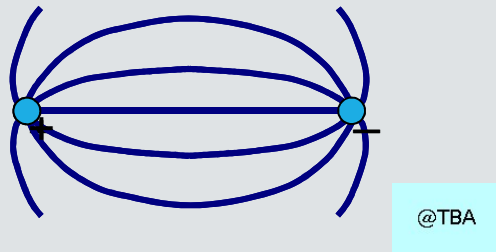

Gluon self-interaction yields *string* (flux tube) pattern at large distance: $F = const$

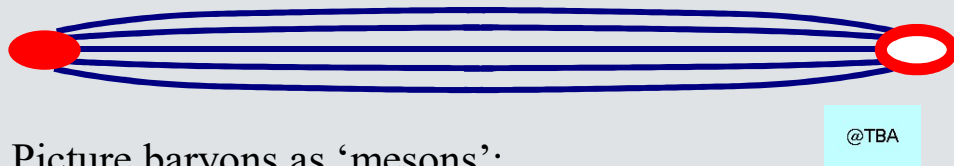

Picture baryons as 'mesons':

$$3 \otimes 3 = 3^* \oplus 6$$

$$qqq = \underbrace{qq}_{\sim \bar{q}} + q$$

Bound States: Confinement - I

$$\alpha_s(|q^2|) \simeq \frac{12\pi}{21 \ln(|q^2|/\Lambda^2)}, \quad |q^2| \gg \Lambda^2$$

When $|q^2| \sim \Lambda^2$, the previous expression does not apply

$\alpha_s(\Lambda^2)$ is large

Strong interaction is strong

Cannot rely on perturbative expansion

In a general sense, expect Λ to mark the low energy range, corresponding to *soft* (low q^2) processes

Bound states: Non-perturbative, 'white', energy scale $\approx \Lambda$

Does $\alpha_s(\Lambda^2)$ correspond to the *color confinement* range?

Very likely. But remember:

It is not yet proven that QCD is a confining theory

Bound States: Confinement - II

QCD: At large color charges separation, field lines compressed to tube-like regions

Reason: Gluon-gluon interaction

→ \sim String



→ $F(r) \approx const \rightarrow V(r) = kr$ Linear confining potential

$k \sim 1 \text{ GeV} / \text{fm}$

Bound States: Confinement - III

Regge trajectories: Old concept, adapted by potential scattering theory
Very general property, not related to any constituent model:
Linear relationship between angular momentum and $(\text{mass})^2$ of resonances

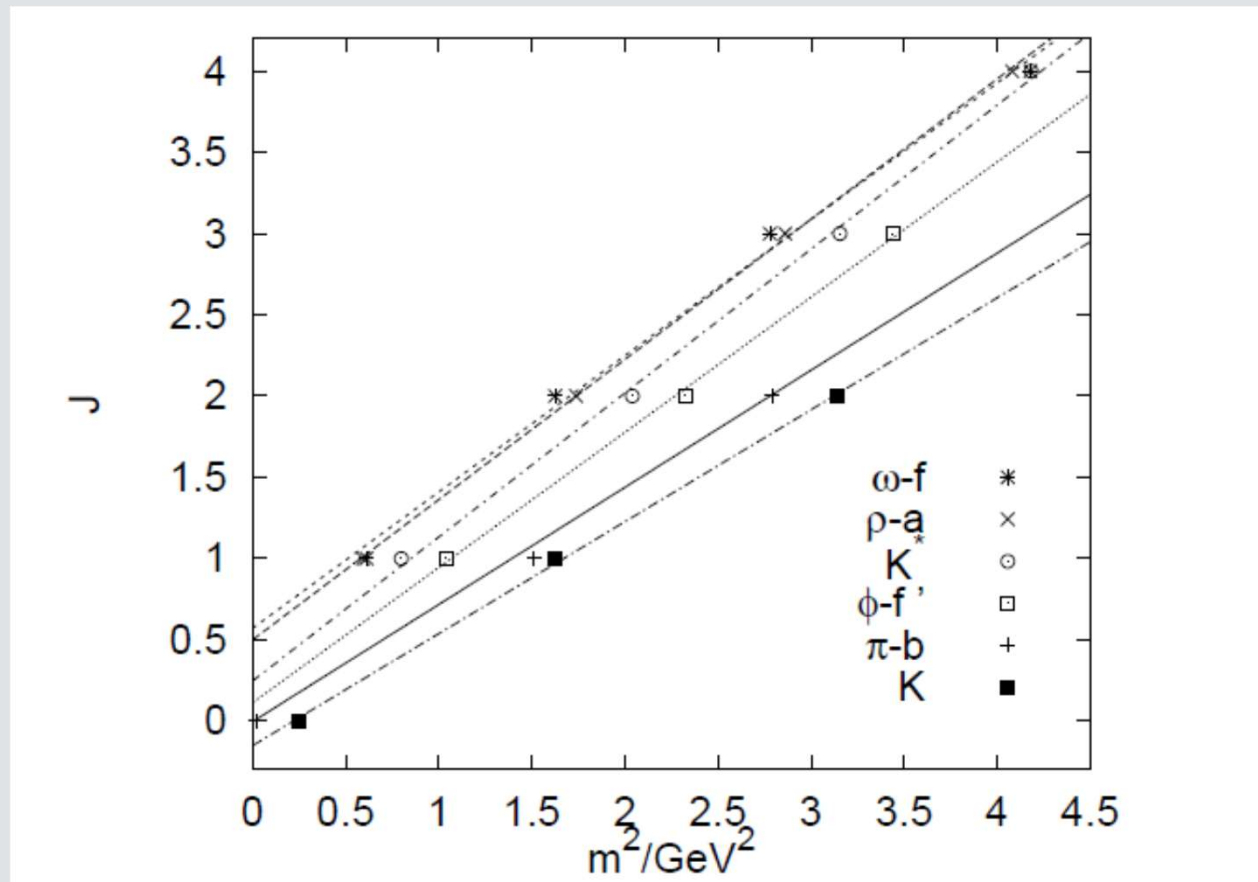

Bound States: Confinement - IV

String model of mesons: Simple 'explanation' of Regge trajectories

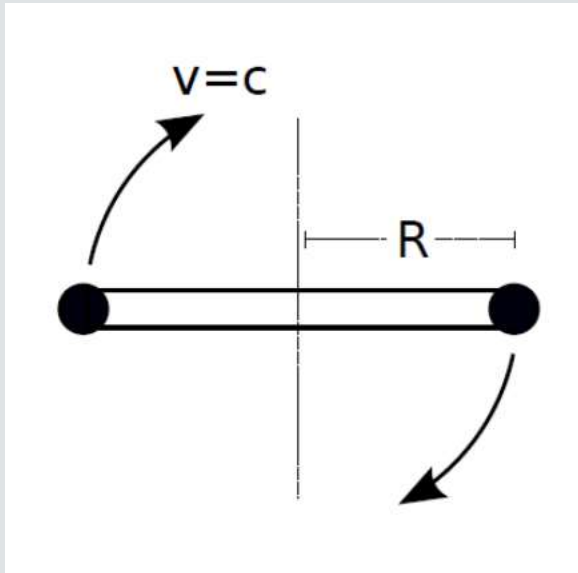

$$F^\mu = \frac{dP^\mu}{d\tau}, F^\mu = (\gamma \mathbf{F} \cdot \mathbf{u}, \gamma \mathbf{F}) \text{ relativistic 2nd law}$$

$$\rightarrow m = E = W = 2 \int_0^R \gamma \mathbf{F} \cdot d\mathbf{r}$$

$$\mathbf{F} = k\hat{\mathbf{r}} \leftrightarrow \text{linear potential}$$

$$\rightarrow m = E = 2 \int_0^R \gamma k\hat{\mathbf{r}} \cdot d\mathbf{r} = 2 \int_0^R \frac{k}{\sqrt{1-\beta^2}} dr$$

$$\beta = \frac{r}{R} \rightarrow m = E = 2k \int_0^R \frac{dr}{\sqrt{1-\left(\frac{r}{R}\right)^2}} = \pi kR$$

$$J = 2k \int_0^R \frac{\frac{r}{R}}{\sqrt{1-\left(\frac{r}{R}\right)^2}} dr = \frac{1}{2} \pi kR^2 = \frac{m^2}{2\pi k}$$

Bound States: Gluonia - I

QCD: Leading to predict new, 'exotic' (= non $q\bar{q}$) mesonic states

Quarkless mesons: no valence quarks

→ *Gluonium*, aka *Glueball*

Expect, among others, exotic quantum numbers

Flavor: **1** Singlet (← no quark)

Color: Bound state → Must be **1** Singlet (← 'white')

→ 2 g at least

$$\mathbf{8} \otimes \mathbf{8} = \mathbf{1} \oplus \mathbf{8} \oplus \mathbf{8} \oplus \mathbf{10} \oplus \overline{\mathbf{10}} \oplus \mathbf{27}$$

Pick singlet:

1 ↔ Symmetric

Bose statistics → Spin × Orbital: Symmetric

Observe:

1 of $SU(3)_C$ exchange-symmetric when originated by

$$\mathbf{8} \otimes \mathbf{8} = \mathbf{1} \oplus \mathbf{8} \oplus \mathbf{8} \oplus \mathbf{10} \oplus \mathbf{10}^* \oplus \mathbf{27}$$

Bound States: Gluonia - II

$$\mathbf{J=L+S}$$

By taking S - wave (space symmetric):

$$L = 0 \rightarrow J = S = 1 \oplus 1 = 0, 1, 2$$

$S = 0, 2$ Symmetric \rightarrow OK

$$\left. \begin{aligned} P &= (-1)^L = +1 \\ C &= (-1)^2 = +1 \end{aligned} \right\} \rightarrow 0^{++}, 2^{++}$$

By taking P - wave (space antisymmetric):

$$L = 1 \rightarrow J = 1 \oplus 1 \oplus 1 = 0, 1, 2, 3$$

$S = 1$ Antisymmetric \rightarrow OK

$$\left. \begin{aligned} P &= (-1)^L = -1 \\ C &= (-1)^2 = +1 \end{aligned} \right\} \rightarrow 1^{-+}, \text{ Exotic!}$$

Compare to $q\bar{q}$, standard mesons:

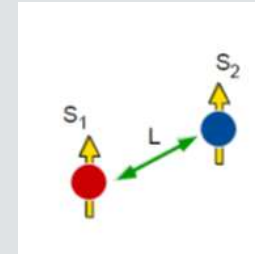

$S = S_1 + S_2$ Allowed: $J^{PC} = 0^{--}, 1^{--}, 1^{--}, 0^{--}, 1^{--}, 2^{--}$
 $J = L + S$ Not allowed: exotic combinations: $J^{PC} = 0^{--}, 0^{-+}, 1^{-+}, 2^{--}$
 $P = (-1)^{L+1}$
 $C = (-1)^{L+S}$

1x1	2							
	+2	2	1					
+1	+1	1	+1	+1				
	+1	0	1/2	1/2	2	1	0	
	0	+1	1/2	-1/2	0	0	0	
		+1	-1	1/6	1/2	1/3		
		0	0	2/3	0	-1/3	2	1
		-1	+1	1/6	-1/2	1/3	-1	-1
				0	-1/2	1/2	2	
				-1	0	1/2	-1/2	-2
						-1	-1	1

Bound States: Gluonia - III

Indeed, build $2g$ state out of single gluon states with defined helicity:

$$U_P |\mathbf{k}, R; -\mathbf{k}, R\rangle = |-\mathbf{k}, L; \mathbf{k}, L\rangle \quad \text{not a } U_P \text{ eigenstate}$$

$$U_P |\mathbf{k}, L; -\mathbf{k}, L\rangle = |-\mathbf{k}, R; \mathbf{k}, R\rangle \quad \text{not a } U_P \text{ eigenstate}$$

$$U_P |\mathbf{k}, R; -\mathbf{k}, L\rangle = |-\mathbf{k}, L; \mathbf{k}, R\rangle \equiv |\mathbf{k}, R; -\mathbf{k}, L\rangle$$

$$\rightarrow U_P \text{ eigenstate, } \eta_P = +1, J_3 = +2 \rightarrow J = 2$$

$$U_P |\mathbf{k}, L; -\mathbf{k}, R\rangle = |-\mathbf{k}, R; \mathbf{k}, L\rangle \equiv |\mathbf{k}, L; -\mathbf{k}, R\rangle$$

$$\rightarrow U_P \text{ eigenstate, } \eta_P = +1, J_3 = -2 \rightarrow J = 2$$

$$|\mathbf{k}, R; -\mathbf{k}, R\rangle \pm |\mathbf{k}, L; -\mathbf{k}, L\rangle$$

$$\rightarrow U_P \text{ eigenstates, } \eta_P = \pm 1, J_3 = 0 \rightarrow J = 0, 2$$

$$\rightarrow \text{Pick } |\mathbf{k}, R; -\mathbf{k}, R\rangle + |\mathbf{k}, L; -\mathbf{k}, L\rangle \text{ (symmetric)} \rightarrow \eta_P = +1$$

Bound States: Quarkonium - I

Small distance: Perturbative!

Indeed: Large quark mass \rightarrow Large Q^2

\rightarrow One gluon exchange OK

Non relativistic effective potential \sim Coulomb-like

$$\rightarrow V\left(r \ll \frac{1}{m_q}\right) \approx -\frac{4}{3} \frac{\alpha_s}{r}$$

Add phenomenological confining term: String inspired

\rightarrow Full potential:

$$V(r) \approx -\frac{4}{3} \frac{\alpha_s}{r} + kr$$

Most interesting $q\bar{q}$ physics case: Heavy, neutral, flavorless mesons

In order to better understand it, revert for a while to simple QED bound state: *Positronium*

Bound States: Quarkonium - II

Bound state of electron - positron: Similar to Hydrogen atom

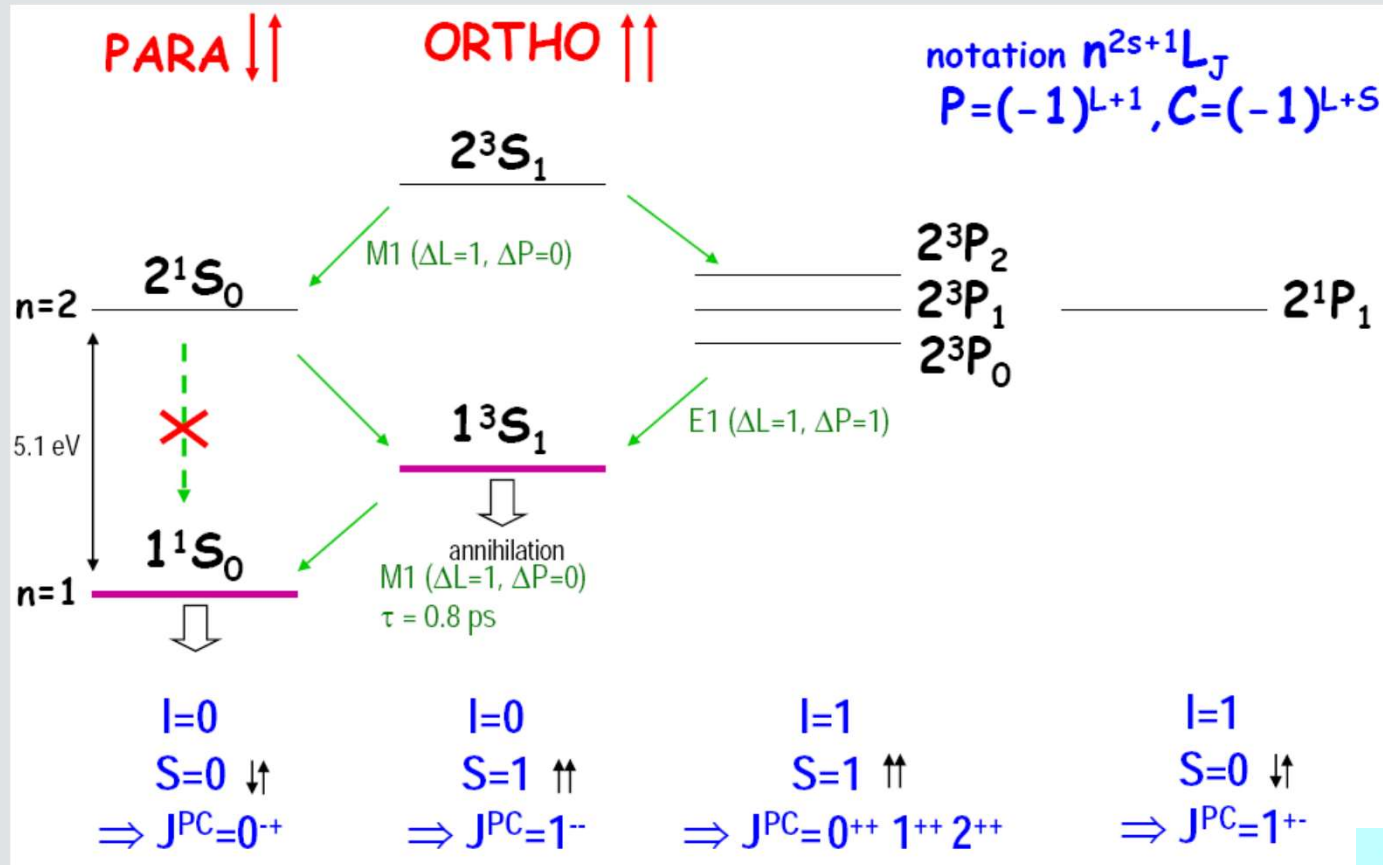

Bound States: Quarkonium - III

Family portrait of *-onia*:

@TBA

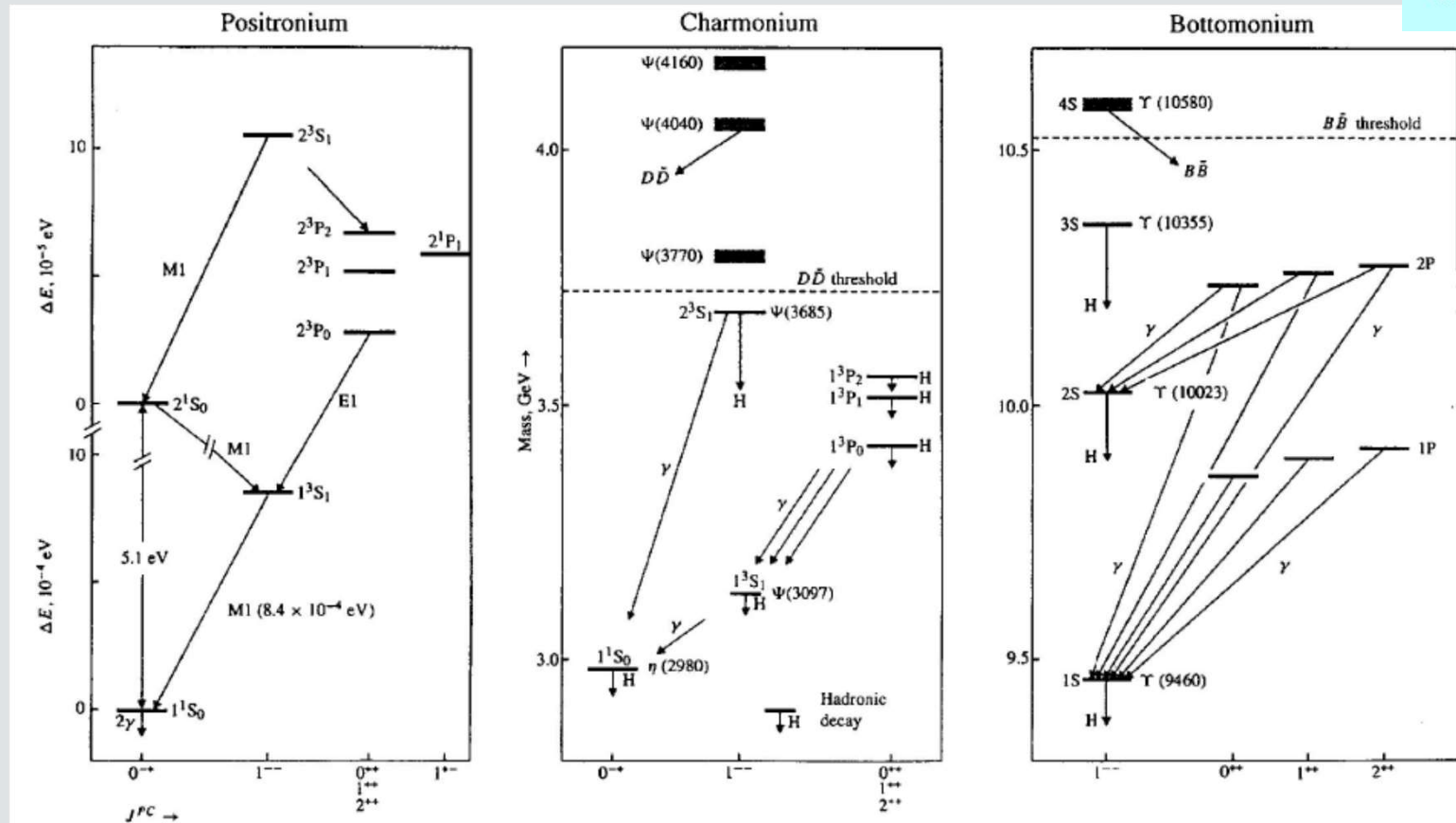

Bound States: Quarkonium - IV

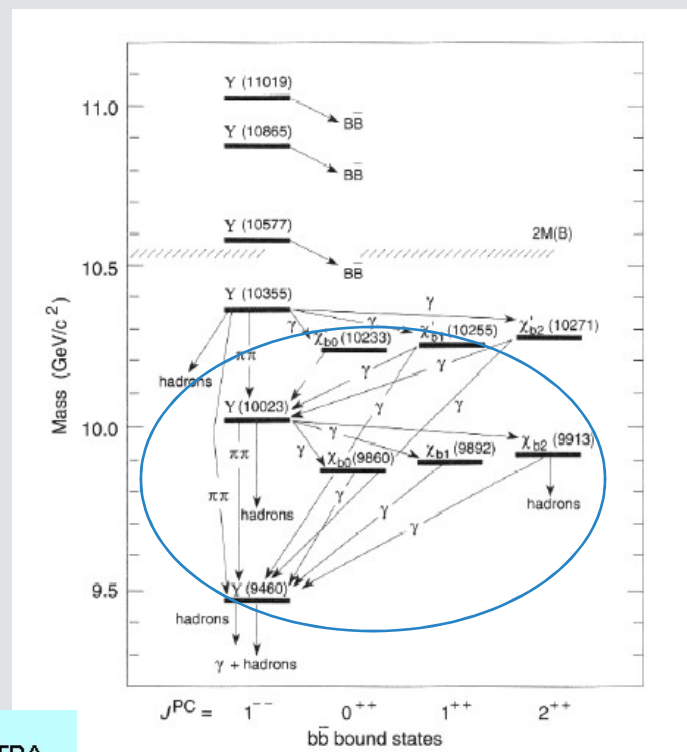
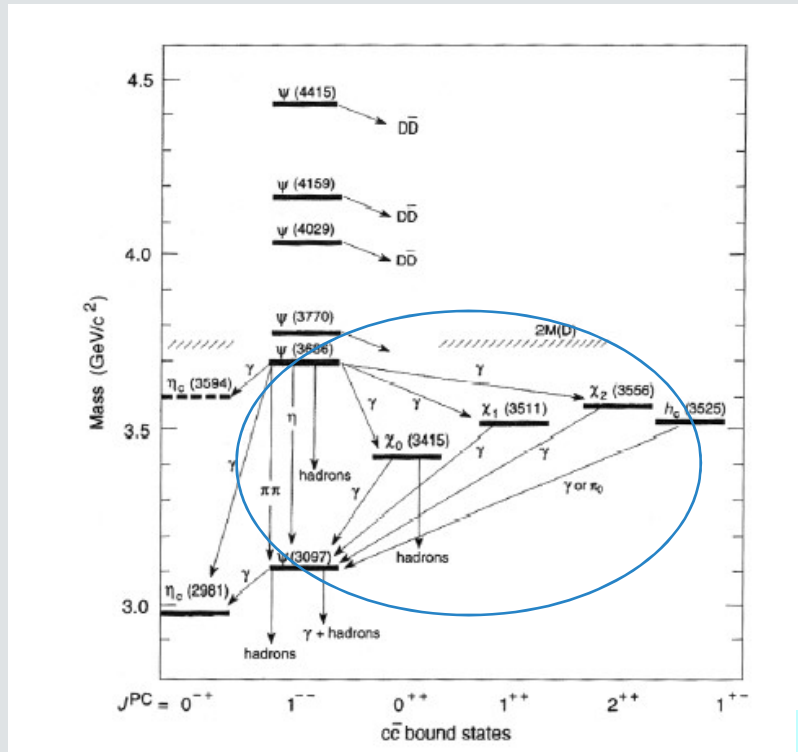

@TBA

Striking similarity, \approx same energy scale *above ground state*

Bound States: Quarkonium - V

Original interest for non-relativistic, Schrodinger equation approach:

$\Delta E(\text{charm}) \simeq \Delta E(\text{bottom})$ Amazingly close

E288	$M(\Upsilon') - M(\Upsilon)$	$M(\Upsilon'') - M(\Upsilon)$
Two-level fit	$650 \pm 30 \text{ MeV}$	
Three-level fit	$610 \pm 40 \text{ MeV}$	$1000 \pm 120 \text{ MeV}$
$M(\psi') - M(\psi)$	$\approx 590 \text{ MeV}$	

Yesterday 1977

Today 2012

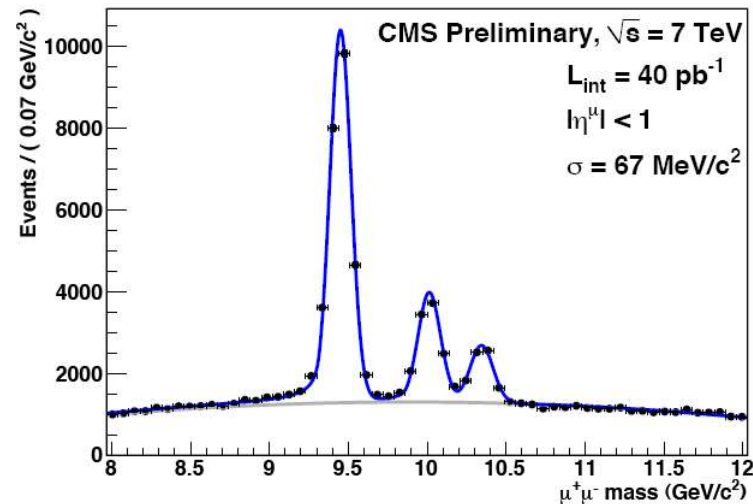
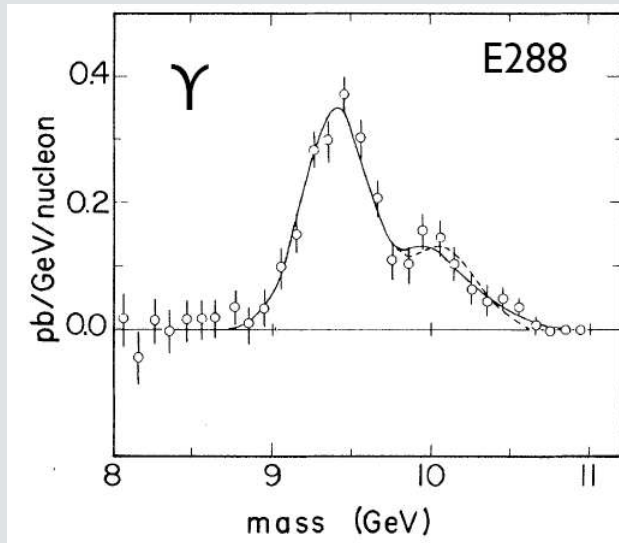

Bound States: Quarkonium - VI

Reminder: Bohr radius

$$R = \frac{n^2}{\alpha m} \rightarrow R_0 = \frac{1}{\alpha m}$$

Consequence of Coulomb potential, static limit of 1 photon diagram

If 1 gluon exchange approximation can be granted, expect for quarkonium

$$R_{q\bar{q}} \sim \frac{1}{\alpha_s m}$$

Observe: m large $\rightarrow R$ small $\rightarrow \alpha_s$ small \rightarrow 1 gluon appr. OK: Self-consistent

Use phenomenological, $q\bar{q}$ confining term like this:

$$V(r) = -\frac{4}{3} \frac{\alpha_s}{r} + kr$$

Solve Schrodinger equation with these terms

(Add more terms to take into account relativistic & color-hyperfine effects)

Question: Which form of effective potential would yield m -independent ΔE ??

Bound States: Quarkonium - VII

Scaling Schroedinger:

$$\psi(r) = R(r)Y_{lm}(\theta, \varphi), \quad u(r) = rR(r)$$

$$\mu = \frac{m}{2} \quad \text{Reduced mass}$$

$$V(r) = \lambda r^\nu \quad \text{Power law potential}$$

$$\frac{\hbar^2}{2\mu} \frac{d^2 u}{dr^2} + \left[E - \lambda r^\nu - \frac{l(l+1)}{2\mu r^2} \right] u(r) = 0 \quad \text{Radial Schrodinger equation}$$

$$r = \rho \left(\frac{\hbar}{2\mu|\lambda|} \right)^{\frac{1}{2+\nu}} \quad \text{Scale radial distance}$$

$$E = \varepsilon \left(\frac{\hbar}{2\mu|\lambda|} \right)^{-\frac{2}{2+\nu}} \frac{\hbar^2}{2\mu} \quad \text{Scale energy}$$

$$w(\rho) = u(r)$$

$$\rightarrow \frac{d^2 w}{d\rho^2} + \left[\varepsilon - \rho^\nu - \frac{l(l+1)}{\rho^2} \right] w(\rho) = 0 \quad \text{Adimensional radial equation}$$

3 parameters:

μ reduced mass $\equiv \frac{m_q}{2}$ for $q\bar{q}$

λ strength

ν exponent

Bound States: Quarkonium - VIII

Scaling laws

Length:	$L \propto (\mu \lambda)^{-\frac{1}{\nu+2}}$	Energy:	$E \propto (\mu)^{-\frac{\nu}{\nu+2}} \lambda ^{\frac{2}{\nu+2}}$
Coulomb	$(\mu \lambda)^{-1}$		$\mu \lambda ^2$
Logarithmic	$(\mu \lambda)^{-\frac{1}{2}}$		$\mu^0 \lambda $
Linear	$(\mu \lambda)^{-\frac{1}{3}}$		$\mu^{-\frac{1}{3}} \lambda ^{\frac{2}{3}}$
Harmonic	$(\mu \lambda)^{-\frac{1}{4}}$		$\mu^{-\frac{1}{2}} \lambda ^{\frac{1}{2}}$
Well	$(\mu \lambda)^0$		μ^{-1}

Bound States: Quarkonium - IX

Cornell potential

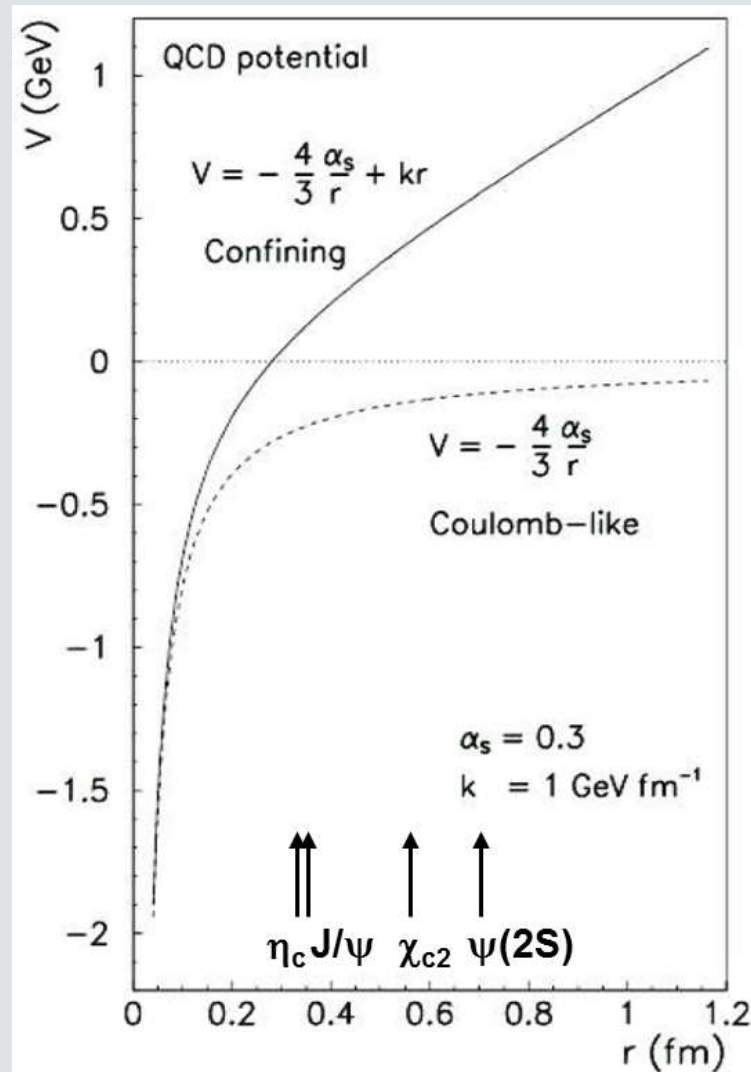

Bound States: Quarkonium - X

Several interesting applications:

1) Logarithmic potential yielding ΔE mass independent

Also obtained by properly fitted Cornell potential

$$\rightarrow \text{Fit} \begin{cases} \alpha_s(q^2 = (2m_q)^2) \sim 0.25 - 0.35 \\ k \sim 1 \text{ GeV} / \text{fm} \end{cases}$$

2) Extra bonus:

$$\text{Probability density} \propto L^{-3} \rightarrow |\psi(0)|^2 \sim (\mu|\lambda|)^{3/2}$$

\rightarrow Fix partial width to e^+e^- of vector mesons

Bound States: EM Decays - I

Attempting to calculate the vector meson decay rate:

$$\Gamma_V = |A_V|^2, \quad A_V = \langle f | T | V \rangle \quad \text{Transition amplitude between } V(\text{initial}), f(\text{final}) \text{ state}$$

The meson is a bound state \rightarrow Initial state *not* a plane wave!

Then expand the amplitude into plane waves:

$$A_V = \sum_p \underbrace{\langle f | T | p \rangle}_{A(\mathbf{p})} \underbrace{\langle p | V \rangle}_{\psi(\mathbf{p})}$$

$A(\mathbf{p})$ plane wave amplitude, $\psi(\mathbf{p})$ momentum space wave function

$$\rightarrow A_V = \int d^3\mathbf{p} A(\mathbf{p}) \psi(\mathbf{p}) = \frac{1}{(2\pi)^{3/2}} \int d^3\mathbf{p} A(\mathbf{p}) \int \psi(\mathbf{r}) e^{i\mathbf{p}\cdot\mathbf{r}} d^3\mathbf{r} = \frac{1}{(2\pi)^{3/2}} \int d^3\mathbf{r} \psi(\mathbf{r}) \int A(\mathbf{p}) e^{i\mathbf{p}\cdot\mathbf{r}} d^3\mathbf{p}$$

$$\text{Take } A(\mathbf{p}) \approx A = \text{const} \rightarrow A_V \approx \frac{A}{(2\pi)^{3/2}} \int d^3\mathbf{r} \psi(\mathbf{r}) \underbrace{\int e^{i\mathbf{p}\cdot\mathbf{r}} d^3\mathbf{p}}_{(2\pi)^3 \delta^3(\mathbf{r})} = (2\pi)^{3/2} A \psi(0)$$

$$\rightarrow \Gamma_V = |A_V|^2 \approx (2\pi)^3 |A|^2 |\psi(0)|^2$$

Why is $A(p) \approx \text{const}$?

Bound States: EM Decays - II

Consider the process involving free quarks (plane wave):

$$q\bar{q} \rightarrow e^+e^-$$

Cross section, averaged over initial, summed over final spin projections:

$$\sigma_{q\bar{q} \rightarrow e^+e^-}(p) = \frac{|A(p)|^2}{\underbrace{(2\pi)^3}} \frac{1}{v} \text{, } v \text{ } q, \bar{q} \text{ relative velocity} \rightarrow \sigma_{q\bar{q} \rightarrow e^+e^-}(p) = |A(p)|^2 \frac{(2\pi)^3}{v}$$

Take 1-photon annihilation QED diagram:

$$\sigma_{q\bar{q} \rightarrow e^+e^-}(p) = \frac{\pi\alpha^2 Q^2}{s} \frac{p_e}{p_q} \left(1 + \frac{v^2}{3} + \frac{4m_q^2}{s} \right)$$

Just the same as $e^+ + e^- \rightarrow \mu^+ + \mu^-$
But: Do not neglect rest mass

For small initial velocity:

$$s \approx (2m_q)^2, p_q \approx m_q \frac{v}{2}$$

$$\sigma_{q\bar{q} \rightarrow e^+e^-}(p) = \frac{\pi\alpha^2 Q^2}{s} \frac{p_e}{p_q} \left(1 + \frac{v^2}{3} + \frac{4m_q^2}{s} \right) \approx \frac{\pi\alpha^2 Q^2}{4m_q^2} \frac{p_e}{m_q \frac{v}{2}} \left(1 + \frac{v^2}{3} + 1 \right)$$

$$\rightarrow \sigma_{q\bar{q} \rightarrow e^+e^-}(p) \approx \frac{\pi\alpha^2 Q^2}{4m_q^2} \frac{p_e}{m_q v} 4 \approx \frac{\pi\alpha^2 Q^2}{m_q^3} \frac{p_e}{v}$$

Bound States: EM Decays - III

Obtain the decay rate:

$$\rightarrow \sigma_{q\bar{q} \rightarrow e^+e^-}(p) = |A(p)|^2 \frac{(2\pi)^3}{v} = \frac{\pi\alpha^2 Q^2}{m_q^3} \frac{p_e}{v}$$

$$\rightarrow |A(p)|^2 = \frac{\pi\alpha^2 Q^2}{m_q^3} \frac{p_e}{v} \frac{v}{(2\pi)^3} = \frac{\pi\alpha^2 Q^2}{m_q^3} \frac{p_e}{(2\pi)^3}$$

$$p_e \approx m_q \rightarrow |A(p)|^2 \approx \frac{\pi\alpha^2 Q^2}{(2\pi)^3 m_q^2} \quad \text{Neglect quark momentum, electron mass}$$

$$m_q \approx \frac{M_V}{2} \rightarrow |A(p)|^2 \approx \frac{4\pi\alpha^2 Q^2}{(2\pi)^3 M_V^2} \quad p\text{-independent OK}$$

We took the average over initial spins for our plane wave cross section, resulting in 3 (triplet) + 1 (singlet) = 4 states

Vector mesons have spin 1, so we should not count spin 0

→ Get another factor 4/3:

$$\Gamma_V \approx (2\pi)^3 |A|^2 |\psi(0)|^2 \approx (2\pi)^3 \frac{4}{3} \frac{4\pi\alpha^2 Q^2}{(2\pi)^3 M_V^2} |\psi(0)|^2 = \frac{16}{3} \frac{\pi\alpha^2 Q^2}{M_V^2} |\psi(0)|^2$$

Van Royen - Weisskopf formula from the roaring '60s

Still incomplete, but useful

Bound States: EM Decays - IV

For Bottomonium and Charmonium:

$$|\psi_q(0)|^2 \sim (\mu|\lambda|)^{3/2} = \left(\frac{m_q}{2}|\lambda|\right)^{3/2} = \frac{m_q^{3/2}}{2\sqrt{2}}|\lambda|^{3/2}$$

$$\rightarrow \Gamma_q \approx \frac{4}{3}(2\pi)^3 \frac{4\pi\alpha^2 Q_q^2}{(2\pi)^3 M_V^2} |\psi(0)|^2 \sim \frac{4}{3} \frac{\pi\alpha^2 Q_q^2}{m_q^2} \frac{m_q^{3/2}}{2\sqrt{2}} |\lambda|^{3/2} = \frac{2\pi\alpha^2 Q_q^2 m_q^{1/2}}{3\sqrt{2}} |\lambda|^3$$

$$\rightarrow \frac{\Gamma_\Upsilon}{\Gamma_\psi} \approx \frac{Q_b^2 m_b^{1/2}}{Q_c^2 m_c^{1/2}} \approx \frac{Q_b^2}{Q_c^2} \sqrt{\frac{9.46}{3.10}} \approx \frac{Q_b^2}{Q_c^2} 1.75$$

$$\Gamma_\psi(ee) \simeq 5.55 \text{ KeV}$$

DORIS (DESY) results (1978):

$$\Gamma_\Upsilon(ee) \simeq 1.26 \text{ KeV}$$

$$\rightarrow \left|\frac{Q_b}{Q_c}\right| \approx \sqrt{\frac{\Gamma_\Upsilon}{\Gamma_\psi} \frac{m_c}{m_b}} \approx \sqrt{\frac{1.26}{5.55} \frac{1}{0.57}} \sim 0.6 \rightarrow |Q_b| = \frac{1}{3} \text{ strongly preferred}$$

Bound States: OZI Rule - I

Okubo-Zweig-Iizuka Rule: *Disconnected diagrams are suppressed*

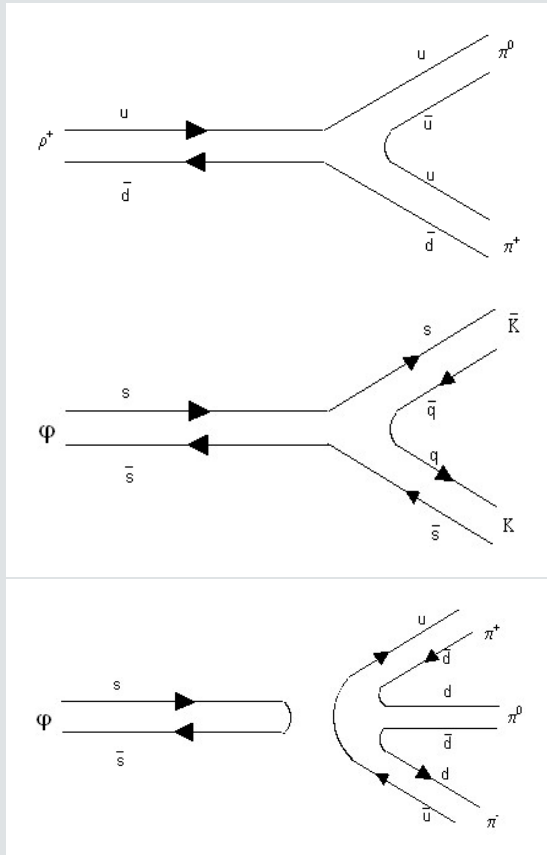

This diagram is connected

This diagram is connected: *BR 83 %*
(with smallish phase space)

This diagram is disconnected: *BR 15 %*
(with much larger phase space)

Bound States: OZI Rule - II

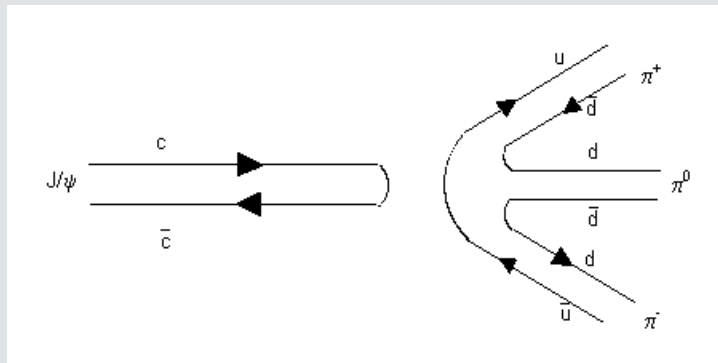
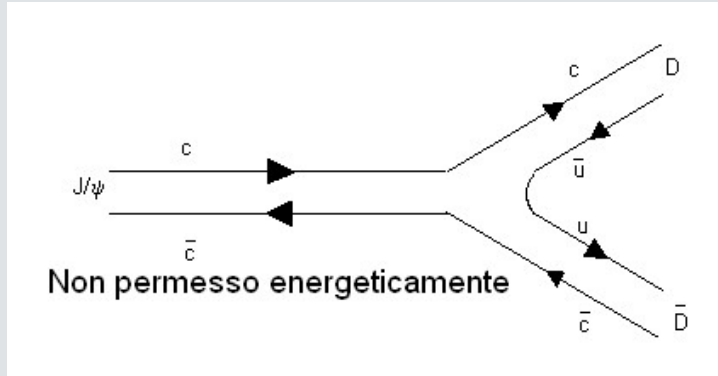

Compare mass and width

$$m_{J/\psi} = 3097 \text{ MeV}, \Gamma_{J/\psi} = 80 \text{ keV} \quad J^{PC} = 1^{--}$$

$$m_{\psi'} = 3686 \text{ MeV}, \Gamma_{\psi'} = 250 \text{ keV} \quad J^{PC} = 1^{--}$$

Explaining the small width:

$$m_{D^0} = 1865 \text{ MeV}$$

$$\rightarrow 2 \times m_{D^0} = 3730 \text{ MeV} > m_{J/\psi}, m_{\psi'}$$

Therefore J/ψ , ψ' decay to open charm is energetically forbidden

→ Decay diagrams are disconnected

→ OZI rule: Decay is suppressed

→ States are very narrow

Bound States: OZI Rule - III

As a general rule

$\rightarrow A \propto \alpha_s^n$ $n =$ number of gluons

Hard gluon $\rightarrow \alpha_s$ small

Soft gluon $\rightarrow \alpha_s$ large

Connected diagrams: Large number of soft gluons $\rightarrow A =$ large

Disconnected diagrams: Small number of hard gluons $\rightarrow A =$ small

Indeed:

Single gluon annihilation is forbidden for mesons by color conservation (meson = **1**, gluon = **8**)

Annihilation of massive quarks yields hard gluons $\rightarrow \alpha_s$ is small

Connected diagrams involve softer gluons $\rightarrow \alpha_s$ is large

Bound States: OZI Rule - IV

Consider quarkonium annihilation into gluons:

$$q\bar{q} \rightarrow g \quad \text{Excluded: } (q\bar{q})_1 \not\rightarrow (1g)_8$$

$$q\bar{q} \rightarrow gg \quad \text{Allowed}$$

$$q\bar{q} \rightarrow ggg \quad \text{Allowed}$$

Decompose the direct product of 2 octets:

$$\mathbf{8} \otimes \mathbf{8} = \mathbf{1} \oplus \mathbf{8} \oplus \mathbf{8} \oplus \mathbf{10} \oplus \mathbf{10}^* \oplus \mathbf{27}$$

Charge Parity:

$$J^{PC} = 0^{-+} \rightarrow C = +1 \rightarrow 2g \text{ OK}$$

$$J^{PC} = 1^{--} \rightarrow C = -1 \rightarrow 3g \text{ OK}$$

Perturbative regime: $A(2g) > A(3g)$

→Pseudoscalars wider than vectors

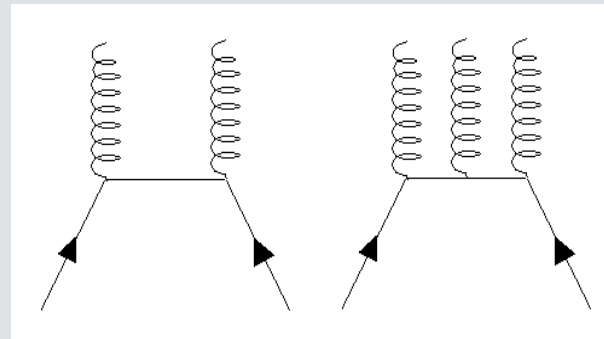

Bound States: OZI Rule - V

By comparison with positronium:

$$(e^+e^-)_{\text{positronium}} \rightarrow \gamma\gamma$$

$$\Gamma[(e^+e^-) \rightarrow \gamma\gamma] = \frac{\alpha^2}{m^2} |\psi(0)|^2$$

$$(c\bar{c})_{\text{charmonium}} \rightarrow \gamma\gamma$$

$$\left\{ \begin{array}{l} e \rightarrow \frac{2}{3}e \rightarrow \alpha \rightarrow \frac{4}{9}\alpha \text{ Quark charge} \\ \times 9 \text{ Sum amplitude over colors} \end{array} \right.$$

$$\Gamma[(c\bar{c}) \rightarrow \gamma\gamma] = \frac{48\alpha^2}{27m_c^2} |\psi_{c\bar{c}}(0)|^2$$

$$(c\bar{c})_{\text{charmonium}} \rightarrow gg$$

From SU(3) algebra: 2 g in a color singlet state

$$\text{Color factor} = \frac{9}{8}$$

$$\Gamma[(c\bar{c}) \rightarrow gg] = \frac{2\alpha_s^2}{3m_c^2} |\psi_{c\bar{c}}(0)|^2$$

But: Positronium rate was obtained by taking the low speed limit of scattering amplitude to 1-photon approx

Is it granted for $c\bar{c}$?

Crystal Ball - I

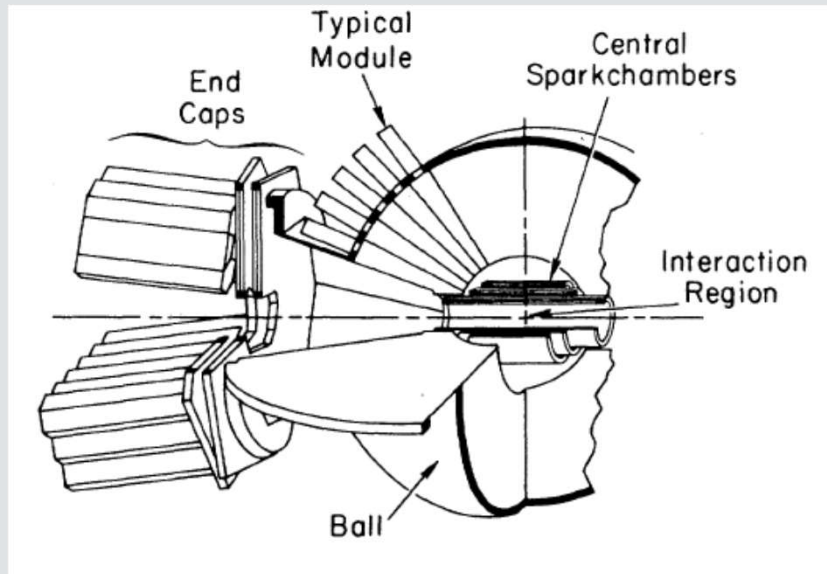

94% of solid angle covered

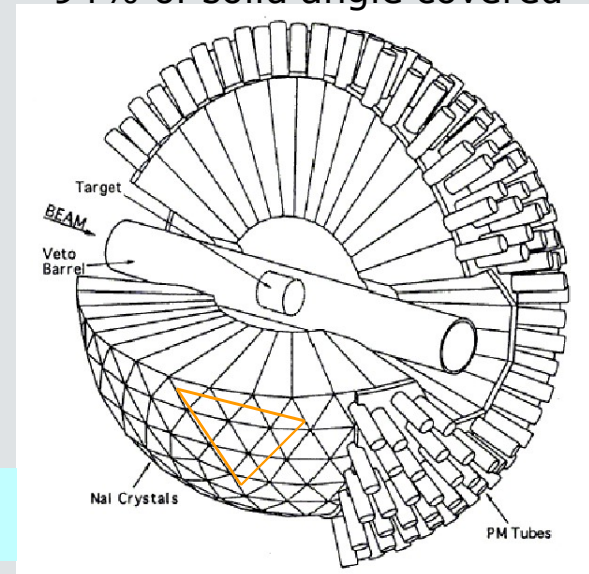

@TBA

Sodium Iodide

$NaI(Tl)$: Inorganic scintillating crystal; Tl is an activator

Merits:

Can grow large crystals

Lots of light

Crystal Ball - II

672 optically isolated NaI(Tl) crystals, 15.7 radiation lengths thick
Inner radius 25.3 cm; Outer radius 66.0 cm

CB geometry: Based on *icosahedron*.

Each of the 20 triangular faces (major triangles) is divided into four minor triangles, each consisting of nine separated crystals.

Each crystal: Truncated triangular pyramid, 40.6 cm high, pointing towards the center of the Ball.

Side on the inner end: 5.1 cm ; Side on the outer end: 12.7 cm

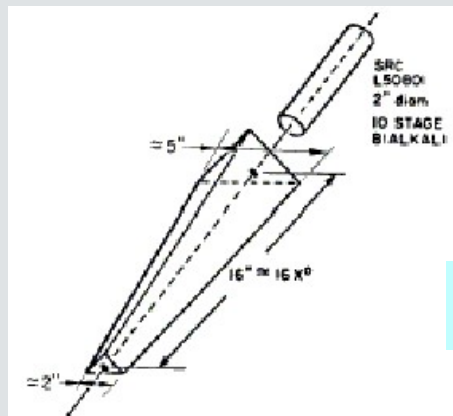

Crystal & Photomultiplier

Crystal Ball - III

Icosahedron magic: Platonic solid (!) , 20 equilateral triangle faces

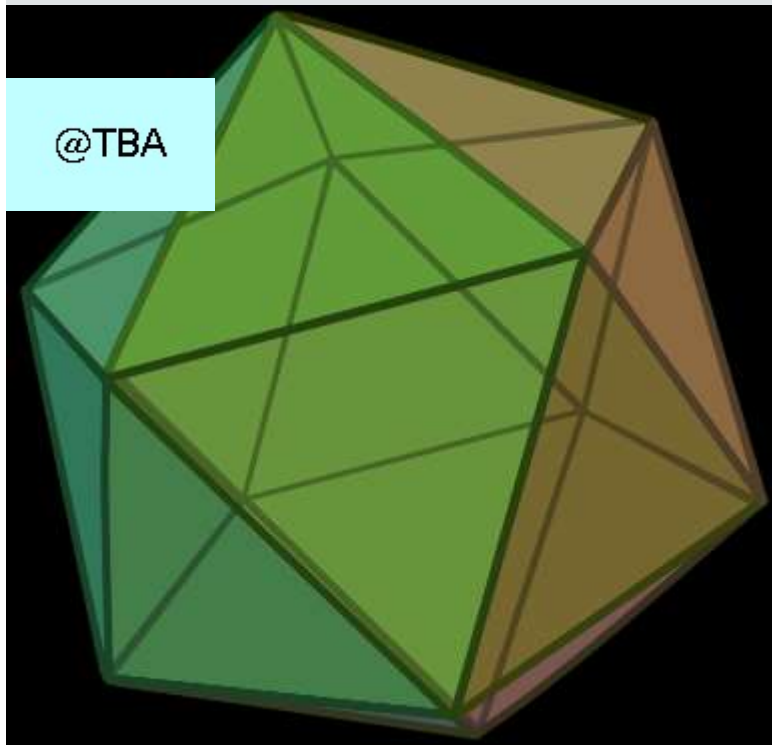

Triangle count:
Large triangle 20

Small triangle 80

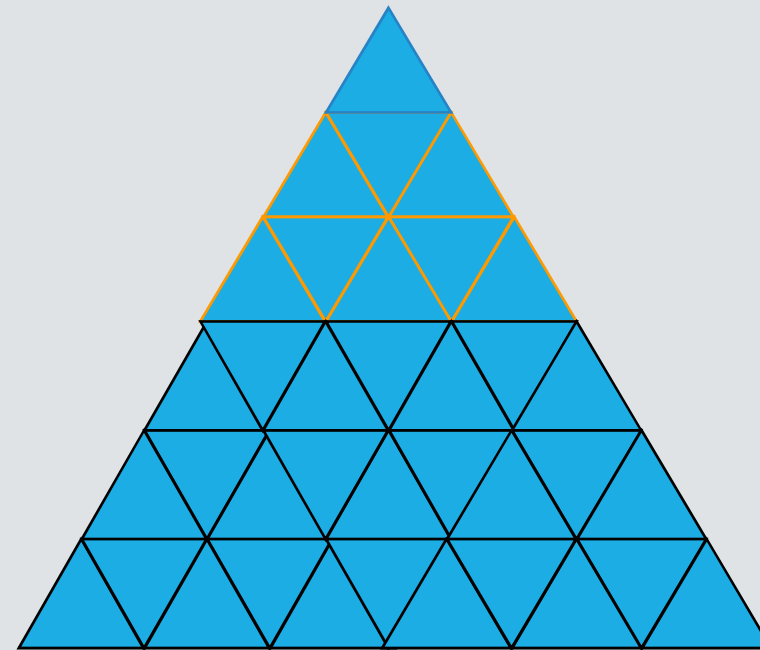

Crystal < 720 (edges)

Crystal Ball - IV

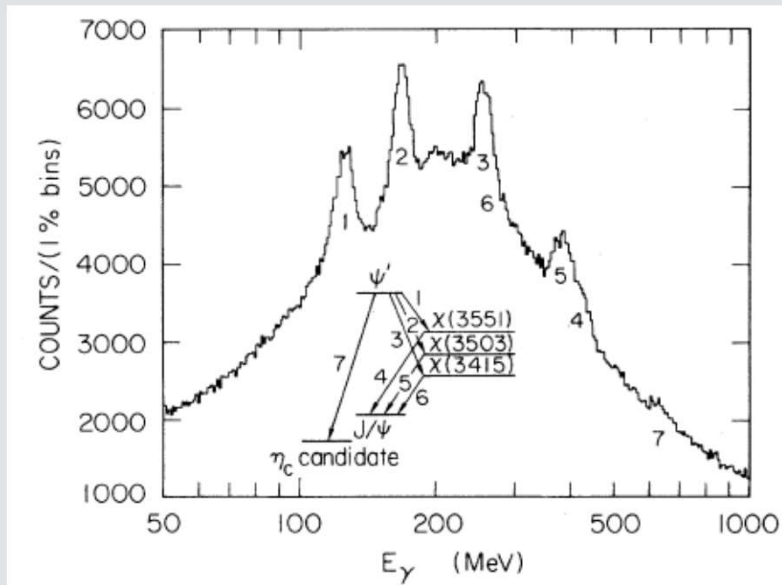

Inclusive photon spectrum

@TBA

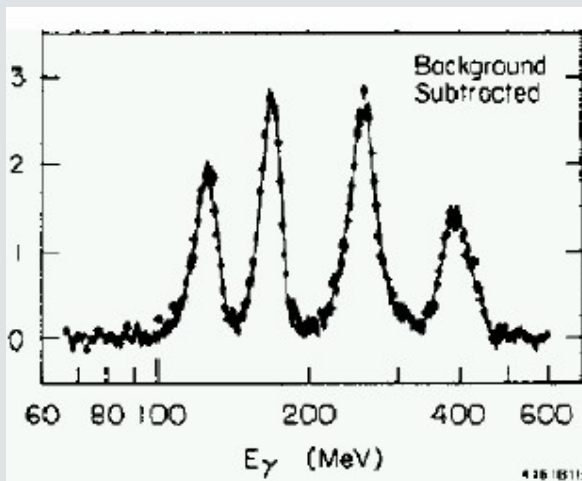

Most important results, among many:
Tune beam energy as to form ψ' (3686)
Observe decays into photon + X

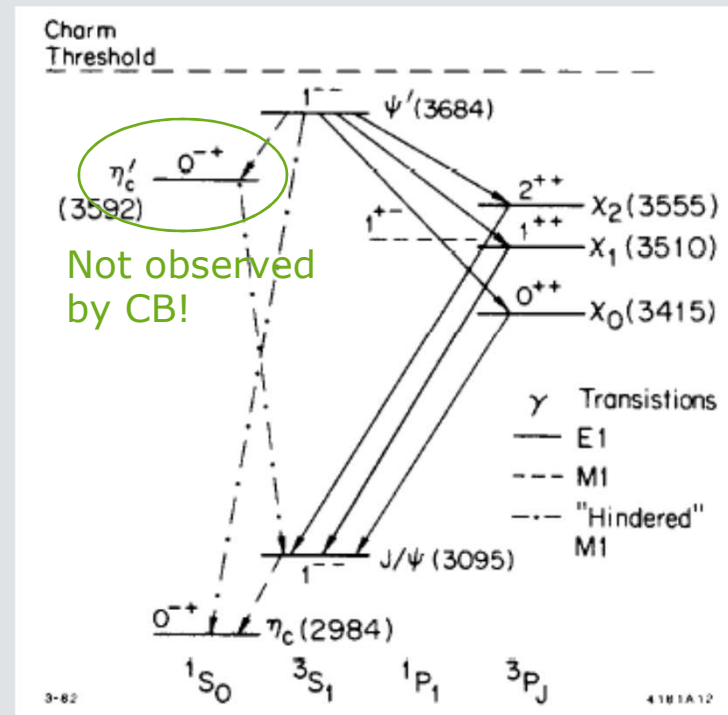

Crystal Ball - V

After moving the CB detector to DORIS (DESY, Hamburg): Bottomonium!
Observation of the P-wave triplets

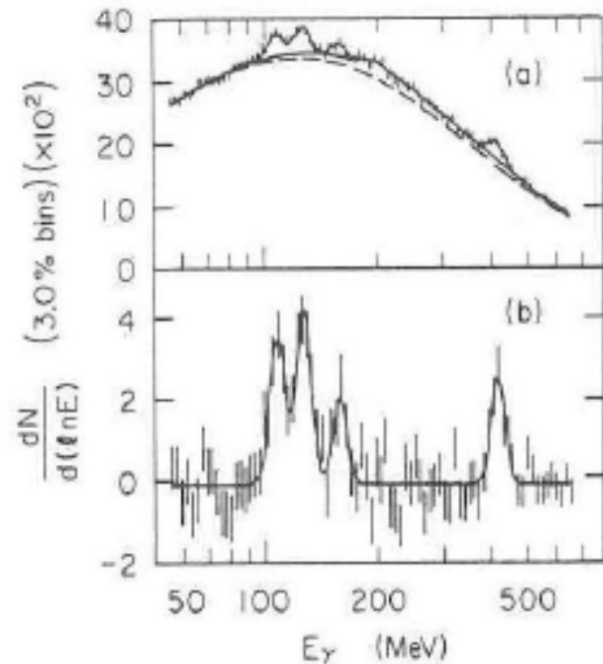

Figure 11.2: The photon spectrum from Υ' decays obtained by the Crystal Ball Collaboration at DORIS II. A triplet of lines corresponding to $\Upsilon' \rightarrow \gamma\chi_b(^3P_{2,1,0})$ is seen between 100 and 200 MeV. The decays $\chi_b \rightarrow \gamma\Upsilon$ produce the unresolved signal between 400 and 500 MeV [R. Nernst *et al.*, *Phys. Rev. Lett.* **54**, 2195 (1985)].

Non-Perturbative QCD - I

Needed to deal with *bound states* and *soft interaction regime*

Very difficult problem

Different approaches available:

Lattice QCD

Chiral Perturbation Theory

Non-Relativistic QCD

Heavy Quark Effective Theory

...

Deep waters, not even surfed in this course

Non Perturbative QCD - II

Perform QCD calculations over a discretized space-time (lattice)

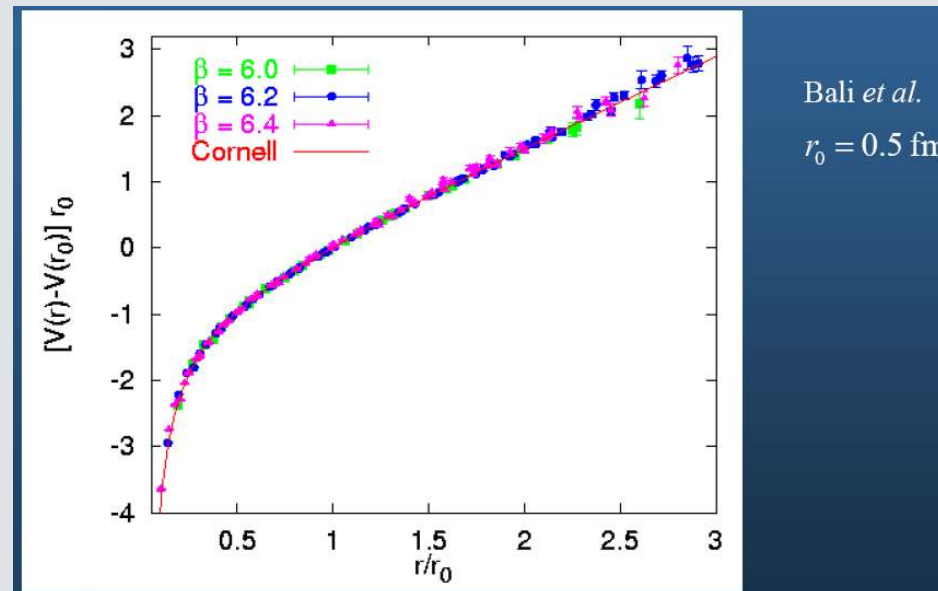

$q\bar{q}$ potential from lattice

$$V(r) = -\frac{4}{3} \frac{\alpha_s}{r} + ar \quad : \quad \text{Not a bad idea after all...}$$

Non Perturbative QCD - III

Examples:

Charmonium levels from lattice

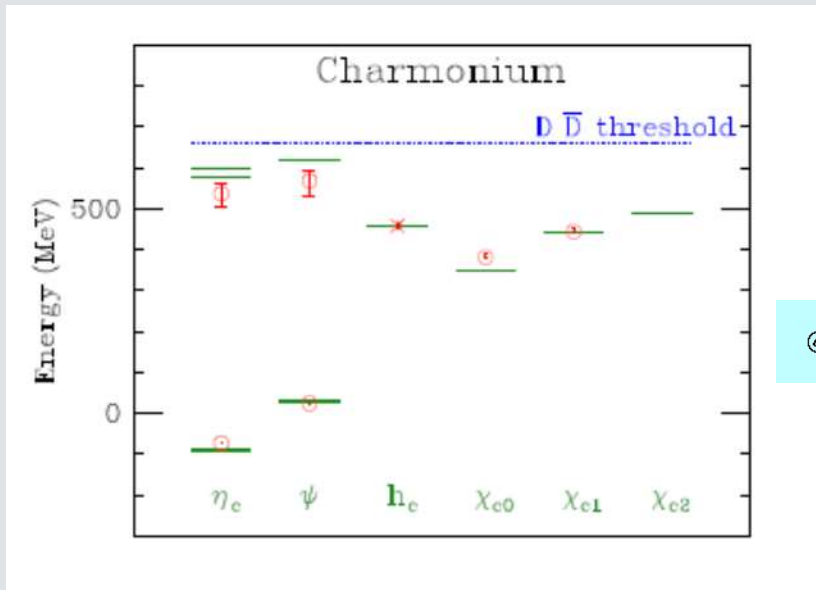

@TBA

Predicted glueball spectrum from lattice

