



Elementary Particles II

2 – Electroweak Interaction

Universal Current-Current Interaction,
Intermediate Vector Bosons, Gauge Symmetry,
Spontaneous Symmetry Breaking, Electroweak
Unification, Neutral Currents, Discovery of W & Z ,
Precision Measurements, Higgs

Electroweak Interaction

2

Standard Model:

Electromagnetic and Weak Interaction unified into Electroweak

Energy scale where unification is evident:

$$E \sim M_W, M_Z \sim 100 \text{ GeV}$$

At lower energies:

Can still find tiny traces of the unification (Electroweak interference, Parity violation in atomic processes,...)

Electroweak interaction split into two, almost not interfering, *effective* interactions:

Electromagnetic

Weak

Non fundamental, useful low energy approximations



V - A - I

3

After a long history of beta decay experiments: *Current-Current (Fermi) Interaction* including *Vector & Axial Vector* terms in order to account for P & C violation

$$H_{\text{int}} = \frac{G_F}{\sqrt{2}} \sum_{i=V,A} C_i (\bar{\psi}_p \Gamma_i \psi_n) \left(\bar{\psi}_e \Gamma^i \left(1 + \frac{C_i'}{C_i} \gamma^5 \right) \psi_\nu \right)$$

Neutrino helicity = -1 yields lepton current = $V - A$

$$C_i' = -C_i \rightarrow \left(1 + \frac{C_i'}{C_i} \gamma^5 \right) \psi_\nu = (1 - \gamma^5) \psi_\nu = -\gamma^\mu (1 - \gamma^5)$$

$$\rightarrow H_{\text{int}} = \frac{G_F}{\sqrt{2}} \left[C_V (\bar{\psi}_p \gamma_\mu \psi_n) (\bar{\psi}_e \gamma^\mu (1 - \gamma^5) \psi_\nu) + C_A (\bar{\psi}_p \gamma_\mu \gamma_5 \psi_n) (\bar{\psi}_e \gamma^\mu \gamma^5 (1 - \gamma^5) \psi_\nu) \right]$$

$$= \frac{G_F}{\sqrt{2}} \left[C_V (\bar{\psi}_p \gamma_\mu \psi_n) (\bar{\psi}_e \gamma^\mu (1 - \gamma^5) \psi_\nu) - C_A (\bar{\psi}_p \gamma_\mu \gamma_5 \psi_n) (\bar{\psi}_e \gamma^\mu (1 - \gamma^5) \psi_\nu) \right]$$

$$= \frac{G_F}{\sqrt{2}} \left[C_V (\bar{\psi}_p \gamma_\mu \psi_n) - C_A (\bar{\psi}_p \gamma_\mu \gamma_5 \psi_n) \right] (\bar{\psi}_e \gamma^\mu (1 - \gamma^5) \psi_\nu)$$

V - A - II

4

Therefore:

$$H_{\text{int}} = \frac{G_F}{\sqrt{2}} C_V \left(\bar{\psi}_p \gamma_\mu \left(1 - \frac{C_A}{C_V} \gamma_5 \right) \psi_n \right) \left(\bar{\psi}_e \gamma^\mu (1 - \gamma^5) \psi_\nu \right)$$

Many violations in weak processes :

Space Parity (large)

Charge Parity (large)

CP (very small)

T (very small)

Flavor conservation (Isospin, S, C, B, T) (larger + smaller)

Lepton numbers (Neutrino oscillations)

V - A - III

5

Observe:

$$H_{\text{int}} = \frac{2G_F}{\sqrt{2}} \left(\bar{\psi}_p \gamma_\mu \left(1 - \frac{C_A}{C_V} \gamma_5 \right) \psi_n \right) \left(\bar{\psi}_e \gamma^\mu \frac{(1 - \gamma^5)}{2} \psi_\nu \right)$$

$$\frac{1 - \gamma^5}{2} \text{ Projection operator} \rightarrow \left[\frac{(1 - \gamma^5)}{2} \right]^2 = \frac{1 - \gamma^5}{2}$$

$$\rightarrow H_{\text{int}} = \frac{2G_F}{\sqrt{2}} \left(\bar{\psi}_p \gamma_\mu \left(1 - \frac{C_A}{C_V} \gamma_5 \right) \psi_n \right) \left(\bar{\psi}_e \gamma^\mu \left[\frac{(1 - \gamma^5)}{2} \right]^2 \psi_\nu \right)$$

$$\rightarrow H_{\text{int}} = \sqrt{2} G_F \left(\bar{\psi}_p \gamma_\mu \left(1 - \frac{C_A}{C_V} \gamma_5 \right) \psi_n \right) \left(\bar{\psi}_e \left(\frac{1 + \gamma^5}{2} \right) \gamma^\mu \left(\frac{1 - \gamma^5}{2} \right) \psi_\nu \right)$$

Lepton current written as *pure vector* between *chiral parts* of ν, e states

→ The weak charged current is just the same as the e.m. current, except it operates between chiral projections with different charge $\Delta Q = \pm 1$

Universality: Leptons

6

Extend V-A to muon weak interactions:

$$\mu^+ \rightarrow e^+ + \bar{\nu}_\mu + \nu_e, \quad \mu^- \rightarrow e^- + \nu_\mu + \bar{\nu}_e \quad \mu \text{ decay}$$

$$\mu^- + p \rightarrow n + \nu_\mu \quad \mu \text{ capture, involves nucleon current}$$

μ decay purely leptonic:

Guess: *Current-Current*, V-A for both electron and muon charged currents

Lagrangian density:

$$L_{V-A} = -\frac{G_F}{\sqrt{2}} [\bar{\nu} \gamma_\mu (1 - \gamma_5) e] [\bar{e} \gamma^\mu (1 - \gamma_5) \nu] + H.C.$$

Compute:

μ Lifetime

Electron energy spectrum

Electron longitudinal polarization

Universal Weak Coupling

7

Measure μ lifetime, get Fermi constant:

$$G_F^{(\mu)} = \sqrt{\frac{192\pi^3}{\tau_\mu m_\mu^5}} = 1.1638 \cdot 10^{-5} \text{ GeV}^{-2}$$

After careful (radiative) corrections:

$$G_F^{(\mu)} = 1.16637 \cdot 10^{-5} \text{ GeV}^{-2}$$

Measure τ lifetime and BR to electron, get Fermi constant:

$$G_F^{(\tau)} = \sqrt{\frac{\Gamma(\tau \rightarrow e\bar{\nu}_e\nu_\tau)}{\Gamma_{tot}} \frac{192\pi^3}{\tau_\tau m_\tau^5}} = 1.1642 \cdot 10^{-5} \text{ GeV}^{-2}$$

Compare to Fermi constant from β decay:

$$G_F^{(\beta)} = 1.1639 \cdot 10^{-5} \text{ GeV}^{-2}$$

→ Universal leptonic charged current!

μ Decay: C & P Violations

8

Polarized μ^\pm decay: μ rest frame

$$\frac{dN^\pm}{dx d\cos\theta} = x^2(3-2x) \left[1 \pm \cos\theta \frac{2x-1}{3-2x} \right]$$

$$x = \frac{p_e}{p_e^{\max}}, \quad \theta \triangleleft (\mathbf{s}_\mu, \mathbf{p}_e)$$

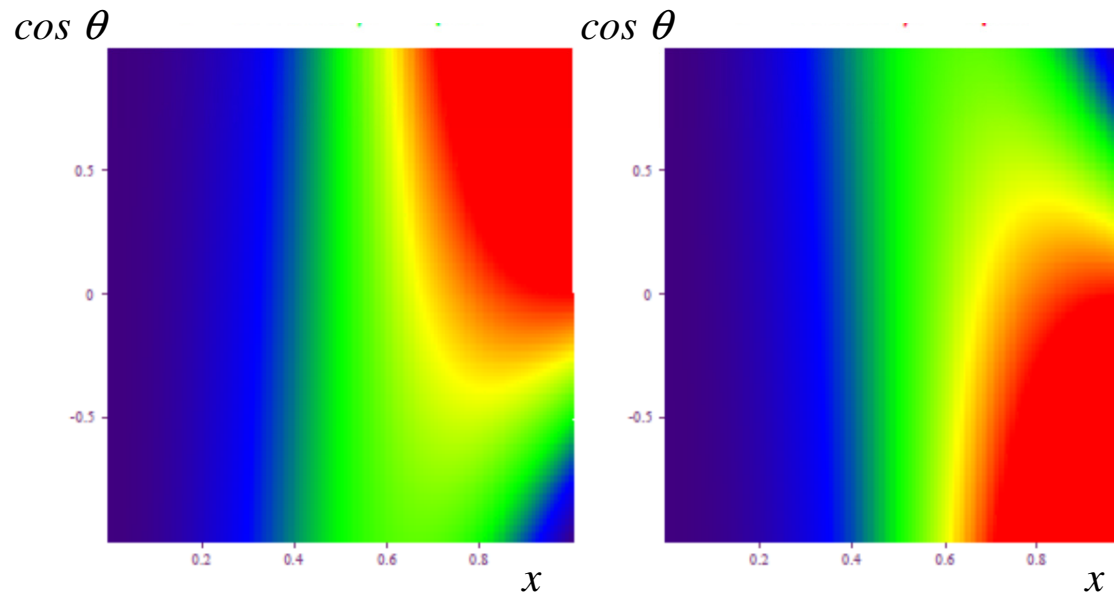

Inverse Muon Decay - I

9

Charged current:

$$\nu_\mu + e^- \rightarrow \mu^- + \nu_e$$

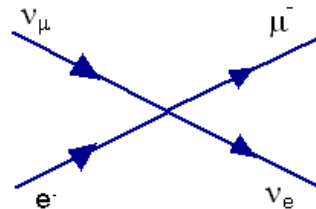

$$\sum_{spin} T_{fi} T_{fi}^* = \sum_{spin} \frac{G_F}{\sqrt{2}} [\bar{u}(3) \gamma^\mu (1 - \gamma^5) u(1)] [\bar{u}(3) \gamma_\nu (1 - \gamma_5) u(1)]^* \cdot$$

$$[\bar{u}(4) \gamma_\mu (1 - \gamma_5) u(2)] [\bar{u}(4) \gamma^\nu (1 - \gamma^5) u(2)]^*$$

$$\sum_{spin} [\bar{u}(a) \Gamma_1 u(b)] [\bar{u}(a) \Gamma_2 u(b)]^* = Tr[\Gamma_1 (\not{p}_b + m_b) \Gamma_2 (\not{p}_a + m_a)]$$

$$\sum_{spin} |T_{fi}|^2 = 64 G_F^2 (p_1 \cdot p_2) (p_3 \cdot p_4)$$

$$\sum_{spin} |T_{fi}|^2 = 256 G_F^2 E^4 \left[1 - \left(\frac{m_\mu}{2E} \right)^2 \right]$$

Inverse Muon Decay - II

10

$$\frac{d\sigma}{d\Omega} = \frac{G_F^2}{\pi^2} E^{*2} \left[1 - \left(\frac{m_\mu}{2E^*} \right)^2 \right]^2$$

$$\rightarrow \sigma = \frac{4G_F^2}{\pi} E^{*2} \left[1 - \left(\frac{m_\mu}{2E^*} \right)^2 \right]^2, \quad E^* \text{ CM energy of } e, \nu$$

$$E^* \simeq \sqrt{2mE_\nu}$$

$$\rightarrow \sigma = \frac{8G_F^2 m_\mu}{\pi} E_\nu \propto E_\nu \quad \text{at high energy}$$

σ badly divergent

→ Unphysical

Neutrino – Lepton Scattering - I

11

Charged current $\nu_e/\bar{\nu}_e - e$ scattering:

$$\nu_e + e^- \rightarrow e^- + \nu_e$$

$$\bar{\nu}_e + e^- \rightarrow \bar{\nu}_e + e^-$$



NB Actually incomplete:

Missing neutral current amplitude leading to the same final states

Cross sections must be evaluated by adding *all* the relevant amplitudes

Neutrino – Lepton Scattering - II

12

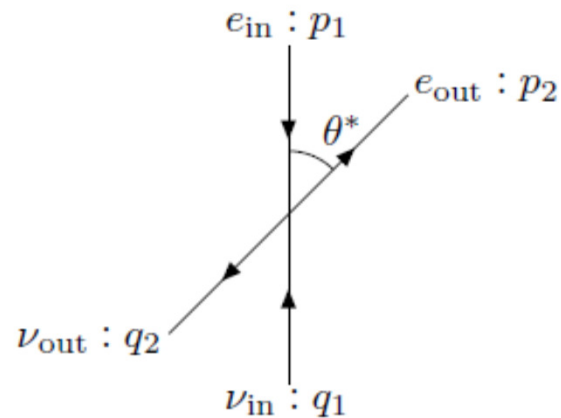

$$T_{fi} = -i \frac{G_F}{\sqrt{2}} [\bar{v}(\nu, q_1) \gamma_\mu (1 - \gamma_5) u(e, p_1)] \cdot [\bar{u}(e, p_2) \gamma^\mu (1 - \gamma_5) v(\nu, q_2)]$$

Neutrino – Lepton Scattering - III

13

$\bar{\nu}e \rightarrow \bar{\nu}e$

$$\frac{d\sigma_{\bar{\nu}e}}{d\Omega^*} = \frac{\langle |T_{fi}|^2 \rangle}{64\pi^2 s} = \frac{G_F^2 2mE_\nu (1 - \cos\theta^*)^2}{16\pi^2}$$

Total cross section:

$$\sigma_{\bar{\nu}e} = \frac{G_F^2 2mE_\nu}{3\pi} \approx 0.574 \cdot 10^{-41} E_\nu (\text{GeV}) \text{ cm}^2$$

$\nu e \rightarrow \nu e$

$$\frac{d\sigma_{\nu e}}{d\Omega^*} = \frac{\langle |T_{fi}|^2 \rangle}{64\pi^2 s} = \frac{G_F^2 2mE_\nu}{4\pi^2}$$

Total cross section:

$$\sigma_{\nu e} = \frac{G_F^2 2mE_\nu}{\pi} \approx 1.72 \cdot 10^{-41} E_\nu (\text{GeV}) \text{ cm}^2$$

Neutrino – Lepton Scattering - IV

14

Total cross sections:

$$\sigma_{\bar{\nu}e} = \frac{G_F^2 2mE_\nu}{3\pi} \approx 0.574 \cdot 10^{-41} E_\nu (\text{GeV}) \text{ cm}^2$$

$$\sigma_{\nu e} = \frac{G_F^2 2mE_\nu}{\pi} \approx 1.72 \cdot 10^{-41} E_\nu (\text{GeV}) \text{ cm}^2$$

as divergent at high energy as the inverse muon decay

NB Cross sections only crude approximations:

Neutral current contribute not included

Interesting factor $\times 3$ between νe and $\bar{\nu}e$

Neutrino – Lepton Scattering - V

15

Origin of factor $\times 3$:



allowed at all angles

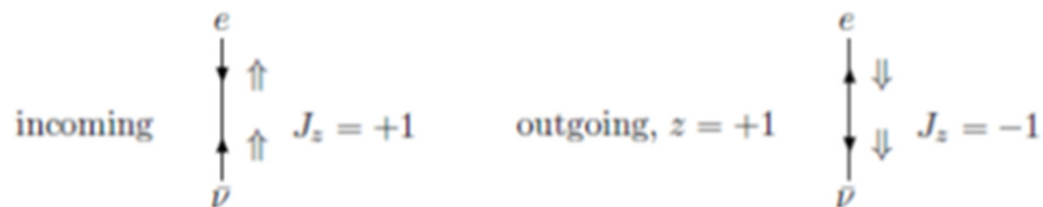

forbidden (angular momentum) at $z = +1$

Unitarity Troubles - I

16

Divergence at high energy : Unitarity bound violated around $E_\nu^* \sim 300 \text{ GeV}$

$$\sigma \leq \frac{4\pi}{k^2} = \frac{4\pi}{E^{*2}} \quad \text{Unitarity bound for S-Wave scattering}$$

Reminder: (Simpler) Spinless potential scattering

Expand incident (plane) wave into angular momentum eigenstates

$$\Psi_i = e^{ikz} = \frac{i}{2kr} \sum_{l=0}^{\infty} (2l+1) [(-1)^l e^{-ikr} - e^{ikr}] P_l(\cos \theta)$$

Outgoing spherical wave phase shifted by potential:

$$\Psi_{total} = \Psi_{scattered} + \Psi_i = \frac{i}{2kr} \sum_{l=0}^{\infty} (2l+1) [(-1)^l e^{-ikr} - \eta_l e^{2i\delta_l} e^{ikr}] P_l(\cos \theta)$$

$$\Psi_{scattered} = \Psi_{total} - \Psi_i = \frac{e^{ikr}}{kr} \sum_{l=0}^{\infty} (2l+1) \frac{\eta_l e^{2i\delta_l} - 1}{2i} P_l(\cos \theta) = \frac{e^{ikr}}{r} f(\theta)$$

Unitarity Troubles - II

17

Outgoing elementary flux:

$$d\Phi_{out} = v_{out} \Psi_{scat} \Psi_{scat}^* r^2 d\Omega = v_{out} |F(\theta)|^2 d\Omega$$

Incident flux:

$$\Phi_{in} = \Psi_{in} \Psi_{in}^* v_{in} = v_{in}$$

$$\rightarrow d\sigma = \frac{\Phi_{out}}{\Phi_{in}} = |F(\theta)|^2 d\Omega$$

$$\sigma = \int |F(\theta)|^2 d\Omega$$

$$\sigma = \frac{1}{k^2} \sum_{l,m} (2l+1) \left[\frac{\eta_l e^{2i\delta_l} - 1}{2i} \right] (2m+1) \left[\frac{\eta_m e^{2i\delta_m} - 1}{2i} \right]^*$$

$$\times \int P_l(\cos\theta) P_m(\cos\theta) d\Omega$$

$$\sigma = \frac{4\pi}{k^2} \sum_l (2l+1) \left| \left[\frac{\eta_l e^{2i\delta_l} - 1}{2i} \right] \right|^2 = \frac{4\pi}{k^2} \sum_l (2l+1) \sin^2 \delta_l$$

$$\rightarrow \sigma_{l=0} = \frac{4\pi}{k^2} \sin^2 \delta_0 \leq \frac{4\pi}{k^2} = \frac{4\pi}{E^{*2}} \quad \text{Unitarity bound for S-Wave scattering}$$

Renormalization Troubles - I

18

Suppose Fermi's theory can be saved by radiative corrections:
Assume divergent cross-section as due to our limited, tree-level approximation
Maybe higher orders could fix it

Take QED as an example

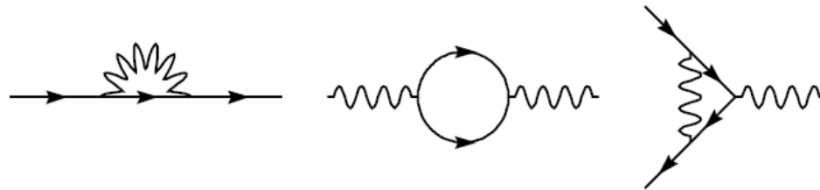

These diagrams (and higher orders) divergent:
However, nice fix available by renormalization procedure

Very successful program, leading to extraordinary accuracy & agreement
between theory and experiment

Renormalization Troubles - II

19

Higher order diagrams in Fermi's theory:

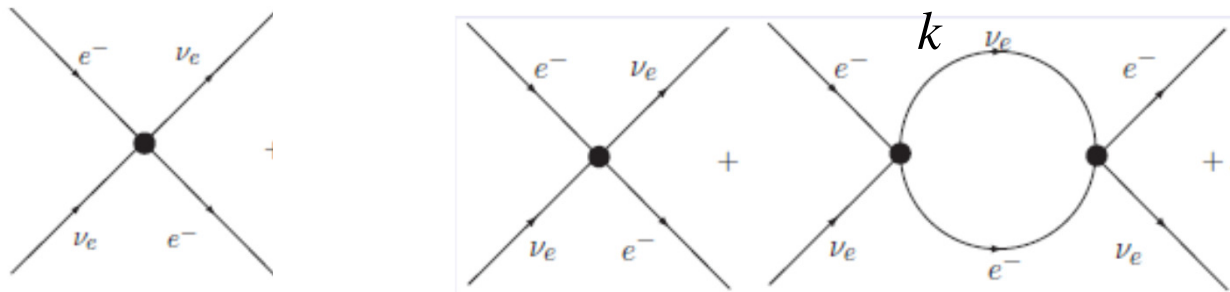

Cannot be fixed by renormalization: Fermi's theory non-renormalizable

Indeed: Each vertex $\sim G_F$

Renormalization Troubles - III

20

Lagrangian density (μ decay etc)

$$L_{Fermi} = -\frac{G_F}{\sqrt{2}} \bar{\nu}_\mu \gamma^\alpha (1 - \gamma^5) \mu \bar{e} \gamma_\alpha (1 - \gamma^5) \nu_e$$

Action dimension:

$$S = \int L_{Fermi} d^4x \rightarrow [S] = ET = EE^{-1} = 0$$

$$\rightarrow [L_{Fermi}] = E^4$$

$$[L_{Fermi}] = [G_F] [\psi^4]$$

$$\text{Field dimension: } [\psi] = E^{\frac{3}{2}}$$

$$\rightarrow [L_{Fermi}] = [G_F] E^6 = E^4$$

$$\rightarrow [G_F] = E^{-2}$$

Amplitude dimension: $[A] = 0$

→ Loop diagrams of higher orders include integrals of higher powers of k

→ More and more divergent

Beyond Fermi's Theory

21

As anticipated:

Current-Current must be a *low energy effective theory*:
Low energy approximation of a more general theory

Replace *contact interaction* (current-current) by *boson exchange*:

Modeled after the electromagnetic interaction

Exchanged particle must be

Charged (Charged current \pm)

Chiral (Only coupled to left chiral parts: Parity violation)

Heavy (Fermi's point-like interaction OK at low energy)

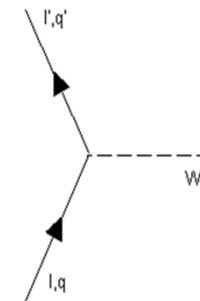

Vertice in corrente carica

Intermediate Vector Boson - I

22

Some key points

A) (Quarks and) Leptons (both) interact through the exchange of *vector particles*

$$\Delta Q = \pm 1$$

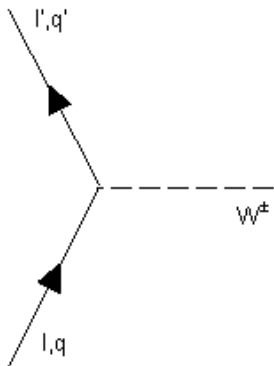

Vertice in corrente carica

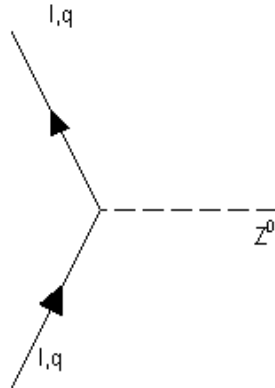

Vertice in corrente neutra

$$\Delta Q = 0$$

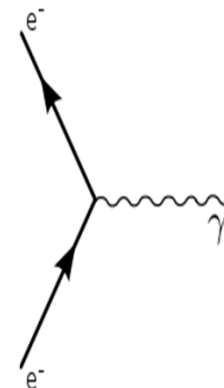

Vertice elettromagnetico

Intermediate Vector Boson - II

23

B) Exchanged vector bosons are (*very*) massive

Range of weak interaction quite small:

Compare β -decay of nuclei, $R < R_{nucleus}$

Cannot tell how large is boson mass, just raw estimate $M \geq 1 \text{ GeV}$

C) Exchanged vector bosons have undefined parity

Parity violation

Intermediate Vector Boson - III

24

W propagator: $-i \frac{g_{\mu\nu} - q_\mu q_\nu / M_W^2}{q^2 - M_W^2}$ (Gauge dependent)

$q^2 \ll M_W^2 \rightarrow -i \frac{g_{\mu\nu} - q_\mu q_\nu / M_W^2}{q^2 - M_W^2} \approx i \frac{g_{\mu\nu}}{M_W^2}$ q^2 -independent

$$T_{fi} \cong \left(\frac{1}{2\sqrt{2}} \right)^2 g_W^2 \left(\bar{u}_f^{(1)} \frac{1}{2} \gamma^\mu (1 - \gamma_5) u_i^{(1)} \right) i \frac{g_{\mu\nu}}{M_W^2} \left(\bar{u}_f^{(2)} \frac{1}{2} \gamma_\nu (1 - \gamma_5) u_i^{(2)} \right)$$

$$\rightarrow T_{fi} \cong i \frac{1}{8} 4\sqrt{2} G_F j^{\mu(1)} j_\mu^{(2)}$$

$g_W^2 \equiv \alpha_W$ Charged current coupling constant

$$G_F = \frac{\sqrt{2}}{8} \left(\frac{g_W}{M_W} \right)^2 \quad \text{Fermi constant}$$

Intermediate Vector Boson - IV

25

Showing how Standard Model diagrams collapse into current-current at low energy:

$$q^2 \ll M_W^2 \rightarrow -i \frac{g_{\mu\nu} - q_\mu q_\nu / M_W^2}{q^2 - M_W^2} \approx i \frac{g_{\mu\nu}}{M_W^2}$$

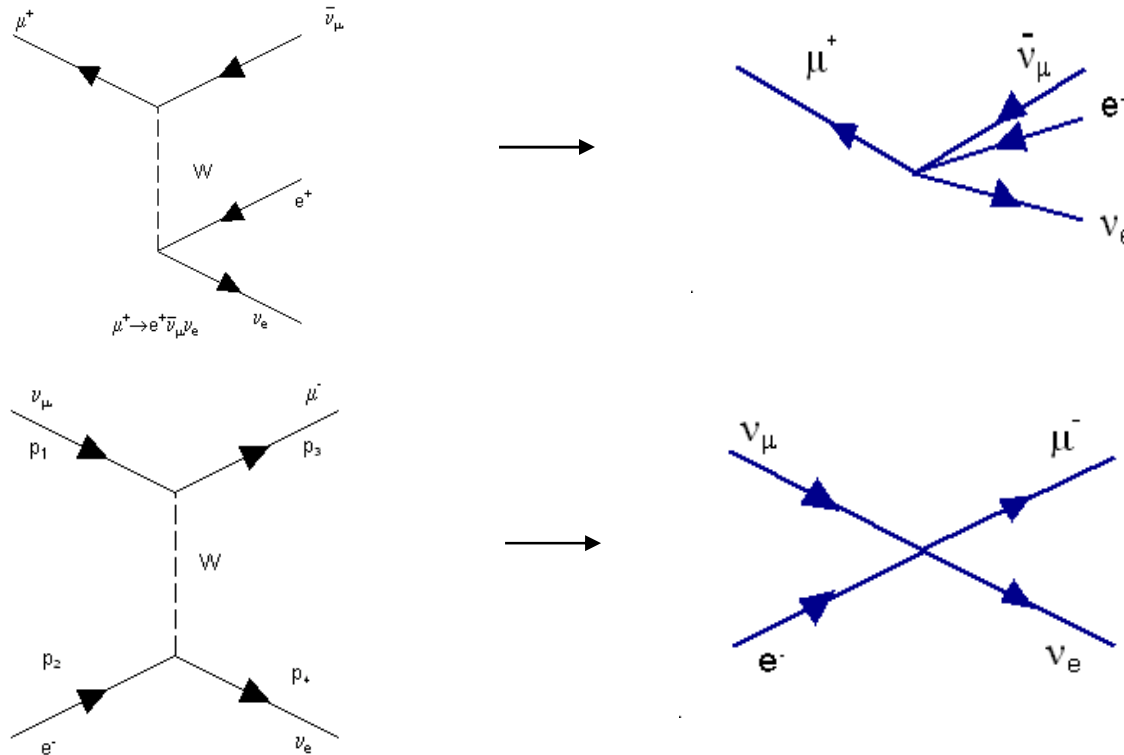

Intermediate Vector Boson - V

26

Good fix for some problems:

Cross sections of several neutrino reactions

Inverse Muon Decay:

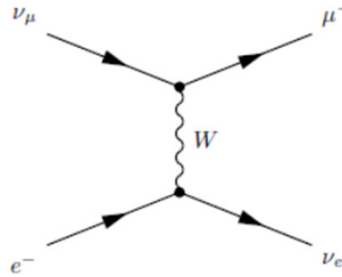

$$\frac{d\sigma}{d\Omega_{CM}} = \frac{G_F^2 M_W^4}{16\pi^2 k^2} \left(\frac{4k^2}{4k^2 - M_W^2} \right)^2 \rightarrow \frac{d\sigma}{d\Omega_{CM}} \approx \begin{cases} \frac{G_F^2 k^2}{\pi^2}, & 4k^2 \ll M_W^2 \\ \frac{G_F^2 M_W^4}{16\pi^2 k^2}, & 4k^2 \gg M_W^2 \end{cases} \rightarrow \sigma \sim \begin{cases} \frac{4G_F^2 k^2}{\pi}, & 4k^2 \ll M_W^2 \\ \frac{G_F^2 M_W^4}{4\pi k^2}, & 4k^2 \gg M_W^2 \end{cases}$$

No divergence!

Intermediate Vector Boson - VI

27

Charged current (only), tree level elastic (anti) electronic neutrino-electron cross sections:

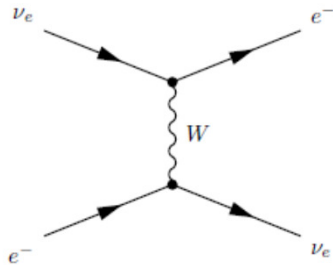

$$\nu_e + e \rightarrow e + \nu_e$$

$$\frac{d\sigma}{d\Omega_{CM}} \simeq \frac{16G_F^2 M_W^2}{\pi^2} \frac{4k^2}{(q^2 - M_W^2)^2}, \quad k^2 \gg m_e^2$$

$$q^2 \simeq -2k^2(1 - \cos\theta)$$

$$s \simeq 4k^2$$

$$\rightarrow \sigma \simeq \frac{G_F^2}{\pi} \frac{4k^2}{1 + \frac{4k^2}{M_W^2}} \xrightarrow{k^2 \gg M_W^2} \frac{G_F^2 M_W^2}{\pi}, \quad \text{no divergence!}$$

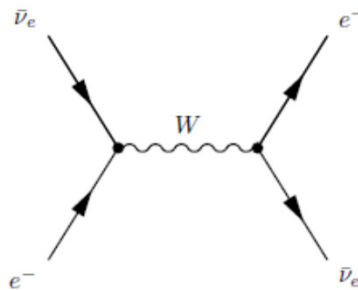

$$\bar{\nu}_e + e \rightarrow \bar{\nu}_e + e$$

$$\sigma \simeq \frac{G_F^2 M_W^4}{3\pi} \frac{4k^2}{16k^4 \left(1 - \frac{M_W^2}{4k^2}\right)^2} = \frac{G_F^2 M_W^4}{3\pi} \frac{1}{4k^2 \left(1 - \frac{M_W^2}{4k^2}\right)^2}$$

$$\sigma \xrightarrow{k^2 \gg M_W^2} \frac{G_F^2 M_W^4}{3\pi s} \quad \text{no divergence!}$$

Intermediate Vector Boson - VII

28

Another dark side of naive IVB model:

Take hypothetical reaction

$$\nu_{\mu} + \bar{\nu}_{\mu} \rightarrow W^{+} + W^{-}$$

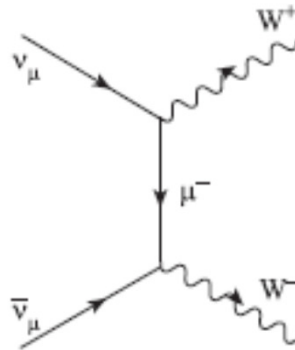

No question, not easy to realize in the lab...

Nevertheless, it should be possible to compute cross section

Anyway, similar issues for the (realistic) reaction

$$e^{+} + e^{-} \rightarrow W^{+} + W^{-}$$

Intermediate Vector Boson - VIII

29

Central issue:

Massive W^\pm bosons in the final state

→ 3 polarization states for a massive vector particle

Rest frame:

$$\left. \begin{aligned} \varepsilon_x &= (0, 1, 0, 0) \\ \varepsilon_y &= (0, 0, 1, 0) \end{aligned} \right\} \varepsilon_T \text{ Transverse polarization}$$

$$\varepsilon_z = (0, 0, 0, 1) \quad \varepsilon_L \text{ Longitudinal polarization}$$

After a z -boost, carrying the W to 4-momentum $k^\mu = (k^0, 0, 0, k)$

$$\varepsilon_T(k) = \varepsilon_T(0)$$

$$\varepsilon_L(k) = \left(\frac{k}{M_W}, 0, 0, \frac{k_0}{M_W} \right) = \frac{k^\mu}{M_W} + O\left(\frac{M_W}{k_0}\right)$$

Intermediate Vector Boson - IX

30

Matrix element ($1 = \nu, W^+, 2 = \bar{\nu}, W^-; p = \nu, k = W$):

$$T_{fi}^{\lambda_1 \lambda_2} = g^2 \varepsilon_{\mu}^{-*}(k_2, \lambda_2) \varepsilon_{\mu}^{+*}(k_1, \lambda_1) \bar{v}(p_2) \gamma^{\mu} (1 - \gamma_5) \frac{(\not{p}_1 - \not{k}_1 + m_{\mu})}{(p_1 - k_1)^2 - m_{\mu}^2} \gamma^{\nu} (1 - \gamma_5) u(p_1)$$

By:

Neglecting μ mass,

restricting to longitudinally polarized W 's ($\lambda = 0$),

taking the high energy ($\gg M_W$) limit for the polarization 4-vectors,

commuting γ_5 :

$$|T_{fi}^{00}|^2 = \frac{g^4}{M_W^4 (p_1 - k_1)^4} \text{Tr} \left[k_2 (1 - \gamma_5) (\not{p}_1 - \not{k}_1) \not{k}_1 \not{p}_1 \not{k}_1 (\not{p}_1 - \not{k}_1) \not{k}_2 \not{p}_2 \right]$$

Summing over initial spins:

$$\sum_{spin} |T_{fi}^{00}|^2 = \frac{g^4}{M_W^4} (p_1 \cdot k_1) (p_2 \cdot k_2) = \frac{g^4}{M_W^4} E^4 (1 - \cos^2 \theta) \rightarrow \frac{d\sigma}{d\Omega^*} = \frac{G_F^2}{8\pi^2} E^2 \sin^2 \theta$$

No simple solution for this problem:

Massive vector particles cannot make it without 3 polarization states

Intermediate Vector Boson - X

31

Compare to well known QED process

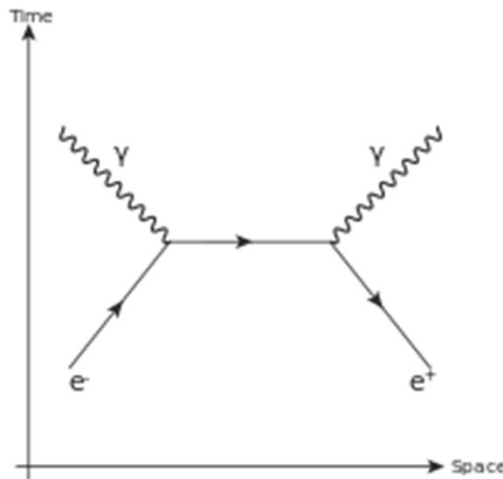

No contribution from longitudinal photons:

Real photons always transverse, as a consequence of *gauge invariance* of QED

Hope the gauge invariance benefits can be extended to weak interactions..

Intermediate Vector Boson - XI

32

Is that a single trouble, unrelated to the full IVB scheme?

Have a look at diagrams including *virtual W*:

Discover that a new divergence hits hard our naive IVB model..

Looking at virtual *W* propagator:

$$\frac{-g_{\mu\nu} + k_{\mu}k_{\nu}/M_W^2}{k^2 - M_W^2} \xrightarrow{k^2 \rightarrow \infty} \text{const}$$

→ Will make diagrams with virtual *Ws* divergent at high energy

Serious illness of IVB model, particularly relevant for *neutral current* processes

Intermediate Vector Boson - XII

33

Neutral current reactions like:

$$\nu_\mu + e^- \rightarrow \nu_\mu + e^-$$

$$\bar{\nu}_\mu + e^- \rightarrow \bar{\nu}_\mu + e^-$$

Not allowed at tree level by our IVB model, only by loop diagrams:

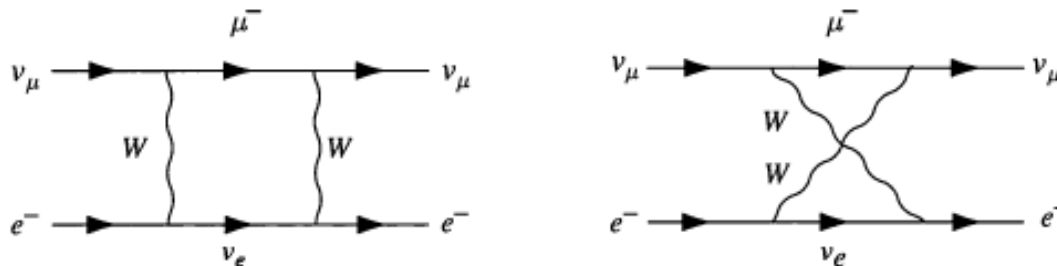

But we can't compute loop diagrams including virtual W :

Divergent, IVB theory *not renormalizable*

Intermediate Vector Boson - XIII

34

Then: Expect strong suppression

After first observations: Cross sections \approx to allowed processes

$$\nu_e + e^- \rightarrow e^- + \nu_e$$

$$\nu_\mu + e^- \rightarrow \mu^- + \nu_e$$

Suggestion:

Maybe neutral currents do exist *at tree level*, e.g.

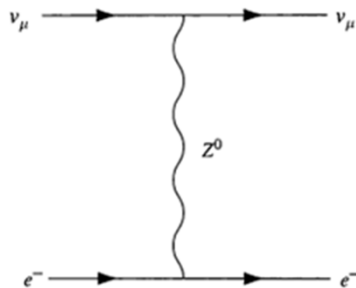

[Indeed, neutral currents are *required* in standard electroweak theory]

Basic requirement: Theory *must be* renormalizable, as is QED

Universality: Quarks

35

Semileptonic and non leptonic processes understood in terms of quarks

Coupling basically similar to leptonic charged currents:

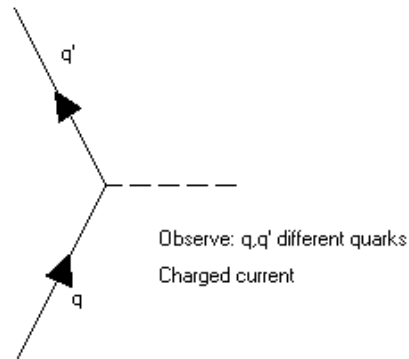

Picture is slightly more complicated, however
Fundamental question:

Is the quark coupling identical to the lepton one?

Families - I

36

Consider charged current of leptons:

Very natural to group charged and neutral leptons into *doublets*, or *families*

$$\begin{pmatrix} \nu_e \\ e^- \end{pmatrix} \quad \begin{pmatrix} \nu_\mu \\ \mu^- \end{pmatrix} \quad \begin{pmatrix} \nu_\tau \\ \tau^- \end{pmatrix}$$

Within each doublet, charged current transitions can be thought as due to emission/absorption of W^\pm bosons, similar to (neutral) e.m. current transitions

$$\begin{array}{ccccc} W^- & \rightarrow & \nu_e & \rightarrow & W^+ \\ & & \uparrow & & \downarrow \\ W^- & \leftarrow & e^- & \leftarrow & W^+ \end{array}$$

Similar for 2nd, 3rd family

Families - II

37

Natural to extend this scheme to quarks

$$\begin{pmatrix} u \\ d \end{pmatrix} \quad \begin{pmatrix} c \\ s \end{pmatrix} \quad \begin{pmatrix} t \\ b \end{pmatrix}$$

$$\begin{array}{ccccc} W^- & \rightarrow & u & \rightarrow & W^+ \\ & & \uparrow & & \\ W^- & \leftarrow & d & \leftarrow & W^+ \end{array}$$

Similar for 2nd, 3rd family

Almost correct, but incomplete:

Does not account for strangeness (more generally, \rightarrow flavour) violating processes

Cabibbo's very ingenious idea:

Quark flavor eigenstates (i.e., quark model eigenstates) are not to be identified with quark weak currents

\rightarrow Weak currents are mixtures of different flavors

By universal convention, mixing is assumed between d , s , b quarks

Families - III

38

In terms of mixed “ d -like” quarks, with just 2 families:

$$\begin{pmatrix} d' \\ s' \end{pmatrix} = \begin{pmatrix} \cos \theta_c & \sin \theta_c \\ -\sin \theta_c & \cos \theta_c \end{pmatrix} \begin{pmatrix} d \\ s \end{pmatrix} \quad \theta_c \text{ Cabibbo's angle}$$

This explain *many* things....

How to extract θ_c ?

Just one example: Get the angle from β decay

$$G_F^{(\beta)} = 0.975 G_F^{(\mu)} \text{ (Remember that 2\% difference ?)}$$

$$\rightarrow G_F^{(\beta)} = \cos \theta_c G_F^{(\mu)}$$

$$\rightarrow \theta_c \simeq 13^\circ$$

Families - IV

39

Extend the idea to 3 families:

From Cabibbo's angle to *Cabibbo-Kobayashi-Maskawa* matrix

$$\begin{bmatrix} V_{ud} & V_{us} & V_{ub} \\ V_{cd} & V_{cs} & V_{cb} \\ V_{td} & V_{ts} & V_{tb} \end{bmatrix} \begin{bmatrix} |d\rangle \\ |s\rangle \\ |b\rangle \end{bmatrix} = \begin{bmatrix} |d'\rangle \\ |s'\rangle \\ |b'\rangle \end{bmatrix}$$

From unitarity:

3 mixing angles

1 complex phase This can account for CP violation

Experimental values:

$$\begin{bmatrix} 0.9753 & 0.221 & 0.003 \\ 0.221 & 0.9747 & 0.040 \\ 0.009 & 0.039 & 0.9991 \end{bmatrix}$$

Almost diagonal

Heavy quarks even more diagonal

$\nu, \bar{\nu}$ - Nucleon Cross Section - I

40

Extend V-A to neutrino-nucleon scattering

$$\nu_{\mu} + N \rightarrow \mu^{-} + X$$

$$\bar{\nu}_{\mu} + N \rightarrow \mu^{+} + X$$

Somewhat similar to e - N , μ - N deep inelastic scattering

Modeling similar to DIS: Parton elastic scattering

Deep inelastic neutrino scattering reveals the same structure as charged lepton DIS

More information: Charged current sensitive to parton charge sign

→ Can separate quark/antiquark contribution

And: Yes, by looking at (anti)neutrino-nucleon DIS structure functions (probing the parton structure by charged – and neutral – weak currents) one concludes that quarks couple to weak currents exactly as leptons

$\nu, \bar{\nu}$ - Nucleon Cross Section - II

41

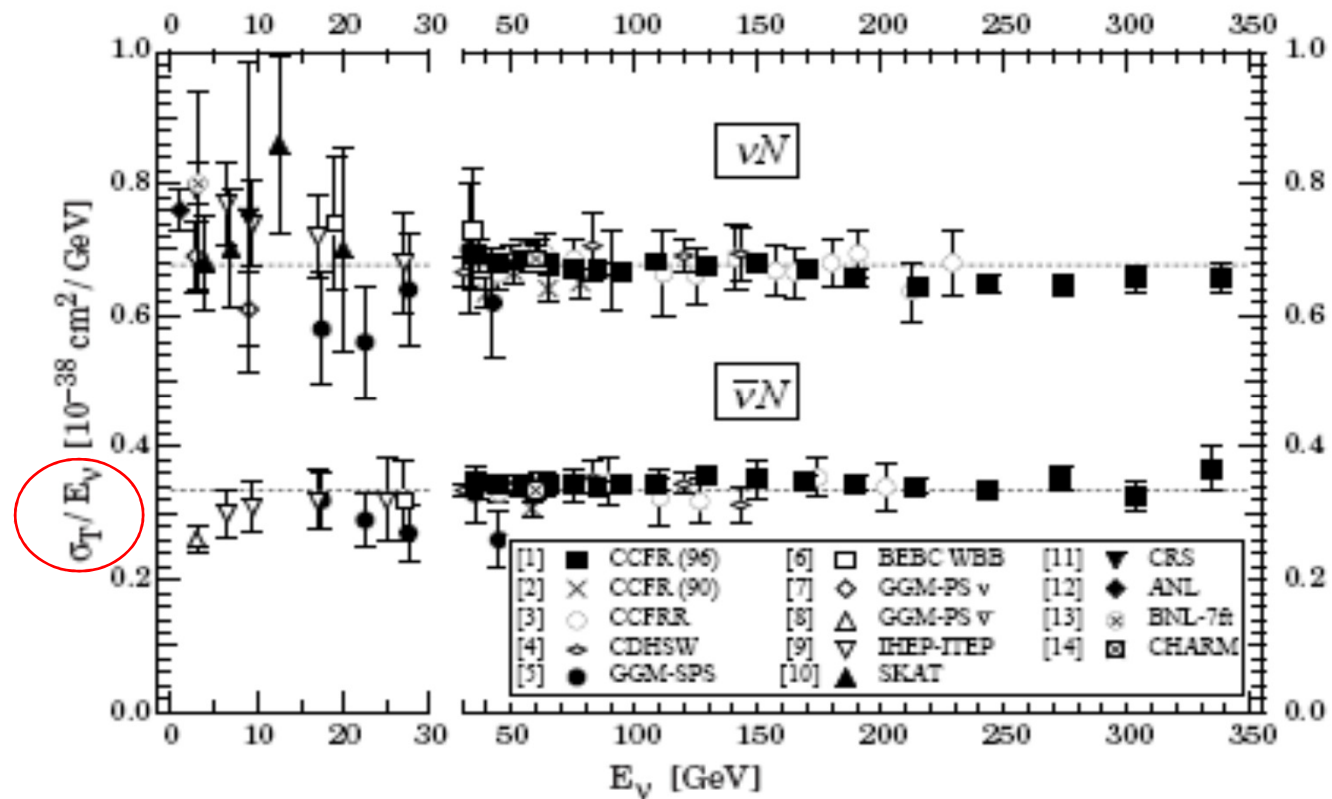

Linearly rising cross section confirmed...

Gauge Symmetry - I

42

What makes QED so successful?

Renormalization program allows for computing observables with high accuracy, comparable to experimental resolution

QED is a renormalizable field theory

Fermi's theory is a non-renormalizable theory

And:

Naive IVB theory of weak interactions is a non-renormalizable theory

Try to discover what makes the difference

Gauge Symmetry - II

43

Back to QED for a while: Reconsider global and local gauge invariance

Free Dirac Lagrangian:

$$L_0 = \bar{\psi}(x)(i\gamma^\mu \partial_\mu - m)\psi(x)$$

Invariant upon global gauge transformation:

$$\begin{cases} \psi(x) \rightarrow \psi'(x) = e^{-i\alpha}\psi(x) \\ \bar{\psi}(x) \rightarrow \bar{\psi}'(x) = e^{+i\alpha}\bar{\psi}(x) \end{cases}, \quad \alpha \text{ constant}$$

Noether's theorem \rightarrow Conserved current:

$$\partial_\mu s^\mu(x) = 0, \quad s^\mu(x) = q\bar{\psi}(x)\gamma^\mu\psi(x)$$

\rightarrow Conserved charge:

$$Q = \int s^0(x) d^3\mathbf{r} = \text{const}$$

Gauge Symmetry - III

44

Non invariant under local gauge transformation:

$$\begin{cases} \psi(x) \rightarrow \psi'(x) = e^{-iqf(x)}\psi(x) \\ \bar{\psi}(x) \rightarrow \bar{\psi}'(x) = e^{+iqf(x)}\bar{\psi}(x) \end{cases}$$

$$L_0 \rightarrow L_0' = L_0 + q\bar{\psi}(x)\gamma^\mu\psi(x)\partial_\mu f(x)$$

Define then a *covariant derivative* as:

$$D_\mu\psi(x) = [\partial_\mu + iqA_\mu(x)]\psi(x)$$

where, upon the previous local gauge transformation:

$$A_\mu(x) \rightarrow A_\mu(x) + \partial_\mu f(x)$$

Then the Lagrangian:

$$L = \bar{\psi}(x)(i\gamma^\mu D_\mu - m)\psi(x) = L_0 - q\bar{\psi}(x)\gamma^\mu\psi(x)A_\mu(x)$$

is invariant

L contains an *interaction* term $(\leftarrow j^\mu A_\mu)$

Gauge Symmetry - IV

45

Consider a single family of massless leptons:

$$L_0 = i\bar{\psi}(x)\gamma^\mu\partial_\mu\psi(x) + i\bar{\psi}_\nu(x)\gamma^\mu\partial_\mu\psi_\nu(x)$$

Chiral spinors:

$$\psi^L(x) = P_L\psi(x) = \frac{1}{2}(1 - \gamma_5)\psi(x)$$

$$\psi^R(x) = P_R\psi(x) = \frac{1}{2}(1 + \gamma_5)\psi(x)$$

$$\rightarrow L_0 = i\bar{\psi}^L(x)\gamma^\mu\partial_\mu\psi^L(x) + i\bar{\psi}_\nu^L(x)\gamma^\mu\partial_\mu\psi_\nu^L(x) + i\bar{\psi}^R(x)\gamma^\mu\partial_\mu\psi^R(x) + i\bar{\psi}_\nu^R(x)\gamma^\mu\partial_\mu\psi_\nu^R(x)$$

Observe: Do not require massless ($\leftarrow L$ -only) neutrino at this stage

Charged current: Connecting two leptons with $\Delta Q = \pm 1$

To encode this into a symmetry scheme, define the doublet:

$$\Psi^L(x) = \begin{pmatrix} \psi_\nu^L(x) \\ \psi^L(x) \end{pmatrix}, \bar{\Psi}^L(x) = (\bar{\psi}_\nu^L(x) \quad \bar{\psi}^L(x))$$

$$\rightarrow L_0 = i\bar{\Psi}^L(x)\gamma^\mu\partial_\mu\Psi^L(x) + i\bar{\psi}^R(x)\gamma^\mu\partial_\mu\psi^R(x) + i\bar{\psi}_\nu^R(x)\gamma^\mu\partial_\mu\psi_\nu^R(x)$$

Gauge Symmetry - V

46

Suppose the L -doublet realizes the fundamental representation of a $SU(2)$ (*gauge*) symmetry of the weak interaction, exactly as $U(1)$ is the (*gauge*) symmetry of QED

Then L -spinors will transform

$$\Psi^L(x) \rightarrow \Psi^{L'}(x) = U(\alpha) \Psi^L(x) = \exp[i\alpha_j \tau_j / 2] \Psi^L(x)$$

$$\bar{\Psi}^L(x) \rightarrow \bar{\Psi}^{L'}(x) = \bar{\Psi}^L(x) U^\dagger(\alpha) = \bar{\Psi}^L(x) \exp[-i\alpha_j \tau_j / 2]$$

$\alpha_1, \alpha_2, \alpha_3$ 3 continuous, real parameters

τ_1, τ_2, τ_3 Pauli matrices

$$[\text{Reminder: } [\tau_i, \tau_j] = 2i\epsilon_{ijk} \tau_k]$$

Also take R -spinors as $SU(2)$ singlets:

$$\Psi^R(x) \rightarrow \Psi^R(x), \Psi_\nu^R(x) \rightarrow \Psi_\nu^R(x) = \Psi_\nu^R(x)$$

$$\bar{\Psi}^R(x) \rightarrow \bar{\Psi}^R(x), \bar{\Psi}_\nu^R(x) \rightarrow \bar{\Psi}_\nu^R(x) = \bar{\Psi}_\nu^R(x)$$

Gauge Symmetry - VI

47

According to Noether's theorem :

Expect conserved current after L invariance under infinitesimal $SU(2)$ transformations :

$$\Psi^L(x) \rightarrow \Psi^{L'}(x) = \left(1 + i\alpha_j \tau_j / 2\right) \Psi^L(x)$$

$$\bar{\Psi}^L(x) \rightarrow \bar{\Psi}^{L'}(x) = \bar{\Psi}^L(x) \left(1 - i\alpha_j \tau_j / 2\right)$$

Identify 3 weak isospin, conserved currents / charges:

$$J_i^\mu(x) = \frac{1}{2} \bar{\Psi}^L(x) \gamma^\mu \tau_i \Psi^L(x)$$

$$I_i^W = \int d^3\mathbf{x} J_i^0(x) = \int \frac{1}{2} \Psi^{L\dagger}(x) \tau_i \Psi^L(x)$$

Make 2 non-Hermitian, linear combinations :

$$J^\mu(x) = 2[J_1^\mu(x) - iJ_2^\mu(x)] = [\bar{\Psi}^L(x) \gamma^\mu \tau_1 \Psi^L(x) - i\bar{\Psi}^L(x) \gamma^\mu \tau_2 \Psi^L(x)]$$

$$J^{\mu\dagger}(x) = 2[J_1^\mu(x) + iJ_2^\mu(x)] = [\bar{\Psi}^L(x) \gamma^\mu \tau_1 \Psi^L(x) + i\bar{\Psi}^L(x) \gamma^\mu \tau_2 \Psi^L(x)]$$

Gauge Symmetry - VII

48

Remember:

$$\Psi^L(x) = \begin{pmatrix} \psi_\nu^L(x) \\ \psi^L(x) \end{pmatrix}, \bar{\Psi}^L(x) = (\bar{\psi}_\nu^L(x) \quad \bar{\psi}^L(x))$$

Then:

$$\begin{aligned} \bar{\Psi}^L(x) \gamma^\mu \tau_1 \Psi^L(x) &= (\bar{\psi}_\nu^L(x) \quad \bar{\psi}^L(x)) \gamma^\mu \begin{pmatrix} 0 & 1 \\ 1 & 0 \end{pmatrix} \begin{pmatrix} \psi_\nu^L(x) \\ \psi^L(x) \end{pmatrix} = (\bar{\psi}_\nu^L(x) \quad \bar{\psi}^L(x)) \gamma^\mu \begin{pmatrix} \psi^L(x) \\ \psi_\nu^L(x) \end{pmatrix} \\ &= \bar{\psi}_\nu^L(x) \gamma^\mu \psi^L(x) + \bar{\psi}^L(x) \gamma^\mu \psi_\nu^L(x) \end{aligned}$$

$$\begin{aligned} i \bar{\Psi}^L(x) \gamma^\mu \tau_2 \Psi^L(x) &= i (\bar{\psi}_\nu^L(x) \quad \bar{\psi}^L(x)) \gamma^\mu \begin{pmatrix} 0 & -i \\ i & 0 \end{pmatrix} \begin{pmatrix} \psi_\nu^L(x) \\ \psi^L(x) \end{pmatrix} = i (\bar{\psi}_\nu^L(x) \quad \bar{\psi}^L(x)) \gamma^\mu \begin{pmatrix} -i \psi^L(x) \\ i \psi_\nu^L(x) \end{pmatrix} \\ &= \bar{\psi}_\nu^L(x) \gamma^\mu \psi^L(x) - \bar{\psi}^L(x) \gamma^\mu \psi_\nu^L(x) \end{aligned}$$

Therefore:

$$\begin{cases} J^\mu(x) = 2 \bar{\psi}^L(x) \gamma^\mu \psi_\nu^L(x) \\ J^{\mu\dagger}(x) = 2 \bar{\psi}_\nu^L(x) \gamma^\mu \psi^L(x) \end{cases} : \text{Just our weak charged currents}$$

Gauge Symmetry - VIII

49

$$J_3^\mu = \frac{1}{2} \bar{\Psi}^L(x) \gamma^\mu \tau_3 \Psi^L(x)$$

$$\bar{\Psi}^L(x) \gamma^\mu \tau_3 \Psi^L(x) = \begin{pmatrix} \bar{\psi}_\nu^L(x) & \bar{\psi}^L(x) \end{pmatrix} \gamma^\mu \begin{pmatrix} 1 & 0 \\ 0 & -1 \end{pmatrix} \begin{pmatrix} \psi_\nu^L(x) \\ \psi^L(x) \end{pmatrix} = \begin{pmatrix} \bar{\psi}_\nu^L(x) & \bar{\psi}^L(x) \end{pmatrix} \gamma^\mu \begin{pmatrix} \psi_\nu^L(x) \\ -\psi^L(x) \end{pmatrix}$$

$$\rightarrow J_3^\mu = \frac{1}{2} [\bar{\psi}_\nu^L(x) \gamma^\mu \psi_\nu^L(x) - \bar{\psi}^L(x) \gamma^\mu \psi^L(x)]$$

Neutral (as opposed to charged) current

Observe:

2nd term is actually a part of the electromagnetic current, up to a constant factor

$$J_{EM}^\mu = -e \bar{\psi}(x) \gamma^\mu \psi(x)$$

Might be possible to unify EM and weak interactions.

But:

Count 3 weak isospin + 1 electromagnetic = 4 currents = 2 charged + 2 neutral

→ Unified symmetry group must be larger than $SU(2)$, which has only 3 parameters

Gauge Symmetry - IX

50

Early models (between '50s and '60s...):

Neutral current \equiv 3rd weak isospin current

Symmetry group is $SU(2)_L \times U(1)_Q$

$SU(2)_L$ (Non Abelian) symmetry group of weak interactions of L -fermions

$U(1)_Q$ (Abelian) symmetry group of QED

Then:

Neutral current has same V-A structure of charged current

(Wrong: When finally observed, neutral current was found \neq V-A)

Weak and Electromagnetic interactions stay independent

(Wrong: At high energy, proofs of unification easily found)

Gauge Symmetry - X

51

Rather assume the symmetry group of (unified) Electroweak interaction is

$$SU(2)_L \times U(1)_Y$$

where Y is a new observable called *weak hypercharge*

$$J_Y^\mu = \frac{1}{e} J_{EM}^\mu - J_3^\mu = -\bar{\psi}(x) \gamma^\mu \psi(x) - \frac{1}{2} [\bar{\psi}_\nu^L(x) \gamma^\mu \psi_\nu^L(x) - \bar{\psi}^L(x) \gamma^\mu \psi^L(x)]$$

$$\rightarrow J_Y^\mu = \frac{1}{2} \bar{\psi}^L(x) \gamma^\mu \psi^L(x) - \frac{1}{2} \bar{\psi}_\nu^L(x) \gamma^\mu \psi_\nu^L(x) - \bar{\psi}^R(x) \gamma^\mu \psi^R(x)$$

→ Conserved charge:

$$Y_W = \int d^3\mathbf{x} J_Y^0(x) = \frac{Q}{e} - I_3^W$$

Fermion EW quantum numbers: Defined by I, I_3, Y

Different for different chiralities!

Gauge Symmetry - XI

52

Find the EW quantum numbers of (chiral) leptons :

$$I_3^W |l^-, L\rangle = -\frac{1}{2} |l^-, L\rangle \quad Y_W |l^-, L\rangle = -\frac{1}{2} |l^-, L\rangle$$

$$I_3^W |\nu_l, L\rangle = +\frac{1}{2} |\nu_l, L\rangle \quad Y_W |\nu_l, L\rangle = -\frac{1}{2} |\nu_l, L\rangle$$

$$I_3^W |l^-, R\rangle = 0 \quad Y_W |l^-, R\rangle = -\frac{1}{2} |l^-, R\rangle$$

$$I_3^W |\nu_l, R\rangle = 0 \quad Y_W |\nu_l, R\rangle = 0$$

Gauge Symmetry - XII

53

Extend to *local* $SU(2)$ gauge transformations: Similar to QCD

L – doublet

$$\Psi^L(x) \rightarrow \Psi^{L'}(x) = U(\alpha)\Psi^L(x) = \exp[i g \omega_j(x) \tau_j / 2] \Psi^L(x)$$

$$\bar{\Psi}^L(x) \rightarrow \bar{\Psi}^{L'}(x) = \bar{\Psi}^L(x) U^\dagger(\alpha) = \bar{\Psi}^L(x) \exp[-i g \omega_j(x) \tau_j / 2]$$

R – singlet

$$\psi^R(x) \rightarrow \psi^{R'}(x) = \psi^R(x), \psi_\nu^R(x) \rightarrow \psi_\nu^{R'}(x) = \psi_\nu^R(x)$$

$$\bar{\psi}^R(x) \rightarrow \bar{\psi}^{R'}(x) = \bar{\psi}^R(x), \bar{\psi}_\nu^R(x) \rightarrow \bar{\psi}_\nu^{R'}(x) = \bar{\psi}_\nu^R(x)$$

$\omega_j(x)$: 3 real parameters, functions of (\mathbf{r}, t)

As for QCD: L_0 not invariant

$$L_0 \rightarrow L_0' = L_0 + \delta L_0 = L_0 - \frac{1}{2} g \bar{\Psi}^L(x) \tau_j \not{\partial} \omega_j(x) \Psi^L(x)$$

Gauge Symmetry - XIII

54

→ Define a covariant derivative for the doublet:

$$\partial^\mu \Psi^L(x) \rightarrow D^\mu \Psi^L(x) = \left[\partial^\mu + i \frac{g}{2} \tau_j W_j^\mu(x) \right] \Psi^L(x)$$

W_j^μ : triplet of (charged, massless) , gluon – like vector fields

Requiring suitable transformation rules:

[Repeated indexes summed, ω_i infinitesimal]

$$W_j^\mu(x) \rightarrow W_j^{\mu \prime}(x) = W_j^\mu(x) - \partial^\mu \omega_j(x) - g \varepsilon_{jik} \omega_i(x) W_k^\mu(x)$$

→ L invariant

Gauge Symmetry - XIV

55

Now consider weak hypercharge $U(1)$ gauge transformations: Similar to QED

$$\psi(x) \rightarrow \psi'(x) = e^{-ig'Yf(x)}\psi(x)$$

$$\bar{\psi}(x) \rightarrow \bar{\psi}'(x) = \bar{\psi}(x)e^{ig'Yf(x)}$$

→ Define a covariant derivative:

$$\partial^\mu \psi(x) \rightarrow D^\mu \psi(x) = [\partial^\mu + ig' B^\mu(x)]\psi(x)$$

B^μ : Neutral, massless photon – like vector field

g' : New coupling constant

$$B^\mu(x) \rightarrow B^{\mu'}(x) = B^\mu(x) - \partial^\mu f(x)$$

→ L invariant

Gauge Symmetry - XV

56

Collecting all pieces together:

$$L = i \left[\bar{\Psi}^L(x) \not{D} \Psi^L(x) + \bar{\psi}^R(x) \not{D} \psi^R(x) + \bar{\psi}_\nu^R(x) \not{D} \psi_\nu^R(x) \right]$$

$$D^\mu \Psi^L(x) = \left[\partial^\mu + i \frac{g}{2} \tau_j W_j^\mu(x) - i \frac{g'}{2} B^\mu(x) \right] \Psi^L(x)$$

$$D^\mu \psi^R(x) = \left[\partial^\mu - i \frac{g'}{2} B^\mu(x) \right] \psi^R(x)$$

$$D^\mu \psi_\nu^R(x) = \partial^\mu \psi_\nu^R(x)$$

Write it as:

$$L = L_0 + L_I$$

$$L_I = -g J_1^\mu(x) W_{1\mu} - g J_2^\mu(x) W_{2\mu} - g J_3^\mu(x) W_{3\mu} - g' J_Y^\mu(x) B_\mu(x)$$

Gauge Symmetry - XVI

57

To understand the meaning of the interaction terms :

Re – write the interaction part

Define

$$W_{\mu}(x) = \frac{1}{\sqrt{2}} [W_{1\mu}(x) - iW_{2\mu}(x)]$$

$$W_{\mu}^{\dagger}(x) = \frac{1}{\sqrt{2}} [W_{1\mu}(x) + iW_{2\mu}(x)]$$

And get for the first 2 terms:

$$\rightarrow L_{I-ch} = -\frac{g}{2\sqrt{2}} [J^{\mu\dagger}(x)W_{\mu}(x) + J^{\mu}(x)W_{\mu}^{\dagger}(x)]$$

Charged current interaction of L – fermions

Gauge Symmetry - XVII

58

Define:

$$W_{3\mu}(x) = \cos \theta_W Z_\mu(x) + \sin \theta_W A_\mu(x)$$

$$B_\mu(x) = -\sin \theta_W Z_\mu(x) + \cos \theta_W A_\mu(x)$$

Reminder:

$$J_Y^\mu(x) = \frac{1}{e} J_{EM}^\mu(x) - J_3^\mu(x)$$

$$\rightarrow \begin{cases} -g' J_Y^\mu(x) B_\mu(x) = -g' \left[\frac{1}{e} J_{EM}^\mu(x) - J_3^\mu(x) \right] \left[-\sin \theta_W Z_\mu(x) + \cos \theta_W A_\mu(x) \right] \\ -g J_3^\mu(x) W_{3\mu} = -g J_3^\mu(x) \left[\cos \theta_W Z_\mu(x) + \sin \theta_W A_\mu(x) \right] \end{cases}$$

→ Remaining terms:

$$\begin{aligned} & -J_{EM}^\mu(x) \frac{g'}{e} \left[-\sin \theta_W Z_\mu(x) + \cos \theta_W A_\mu(x) \right] + \\ & -J_3^\mu(x) \left\{ g \left[\cos \theta_W Z_\mu(x) + \sin \theta_W A_\mu(x) \right] + g' \left[-\sin \theta_W Z_\mu(x) + \cos \theta_W A_\mu(x) \right] \right\} \end{aligned}$$

Gauge Symmetry - XVIII

59

Most simple way of unifying the EM and weak interaction :

Require this condition on g', θ_w constants

$$g \sin \theta_w = g' \cos \theta_w = e$$

and contemplate the miracle:

$$L_I = -J_{EM}^\mu(x) A_\mu - \frac{g}{2\sqrt{2}} J^{\mu\dagger}(x) W_\mu + J^\mu(x) W_\mu^\dagger - \frac{g}{\cos \theta_w} \left[J_3^\mu(x) - \sin^2 \theta_w \frac{J_{EM}^\mu(x)}{e} \right] Z_\mu(x)$$

Electromagnetic interaction

Charged current weak interaction

Neutral current weak interaction

Neutral Current - I

60

As a result of the weak-electromagnetic unification, neutral currents are *different* from charged

Lorentz structure not $V - A$

$$-i \frac{g_W}{\sqrt{2}} \gamma^\mu \frac{(1 - \gamma^5)}{2} \quad \text{Charged}$$

$$-i g_Z \gamma^\mu \frac{(C_V^f - C_A^f \gamma^5)}{2} \quad \text{Neutral}$$

	Fermion	C_V	C_A
Coupling	ν_e, ν_μ, ν_τ	$+1/2$	$+1/2$
	e, μ, τ	$-1/2 + 2 \sin^2 \theta_W$	$-1/2$
	u, c, t	$+1/2 - 4/3 \sin^2 \theta_W$	$+1/2$
	d, s, b	$-1/2 + 2/3 \sin^2 \theta_W$	$-1/2$

θ_W new fundamental constant

What about interaction strength?

Neutral Current - II

61

Tight relationship between weak and electromagnetic interactions

Coupling constants:

$$g_w = \frac{e}{\sin \theta_w}$$

$$g_z = \frac{e}{\sin \theta_w \cos \theta_w}$$

Charged, neutral and electromagnetic couplings fixed by 2 universal constants:

e : Elementary charge

θ_w : Weinberg angle, new fundamental constant

$$\sin^2 \theta_w = 0.23122 \pm 0.00015$$

Neutral Current - III

62

Expect to observe typical processes like:

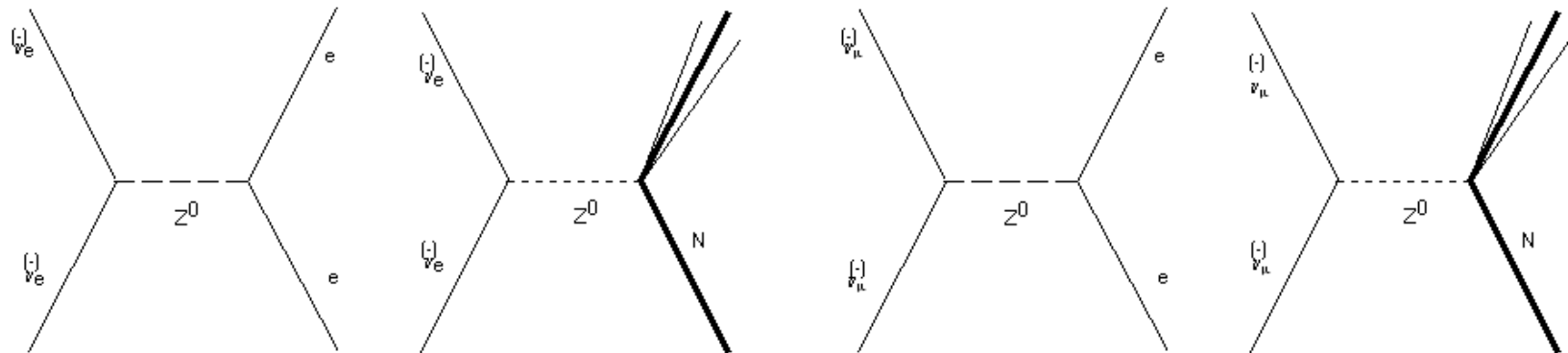

$(\nu_e, \bar{\nu}_e) + e \rightarrow (\nu_e, \bar{\nu}_e) + e$ Contributing to elastic scattering

$(\nu_\mu, \bar{\nu}_\mu) + e \rightarrow (\nu_\mu, \bar{\nu}_\mu) + e$

$(\nu_e, \bar{\nu}_e) + N \rightarrow (\nu_e, \bar{\nu}_e) + \text{hadron shower}$

$(\nu_\mu, \bar{\nu}_\mu) + N \rightarrow (\nu_\mu, \bar{\nu}_\mu) + \text{hadron shower}$

} New

Gauge Boson Terms - I

63

As for *QED*:

Additional terms required in order to account for:

Energy, Momentum, Angular Momentum

carried over by the fields

Weak Hypercharge field:

$$-\frac{1}{4} B_{\mu\nu}(x) B^{\mu\nu}(x)$$

$$B^{\mu\nu}(x) = \partial^\nu B^\mu(x) - \partial^\mu B^\nu(x)$$

Similar to *QED*: Abelian symmetry $U(1)$

Weak Isospin fields:

$$-\frac{1}{4} \sum_{i=1}^3 G_{\mu\nu}^{(i)}(x) G^{(i)\mu\nu}(x)$$

$$G^{(i)\mu\nu}(x) = \underbrace{\partial^\nu W^{(i)\mu}(x) - \partial^\mu W^{(i)\nu}(x)}_{F^{(i)\mu\nu}(x)} + g \sum_{i,j=1}^3 \varepsilon_{ijk} W^{(j)\mu}(x) W^{(k)\nu}(x)$$

Similar to *QCD*: Non-Abelian symmetry $SU(2)_L$

Gauge Boson Terms - II

64

Gauge Boson Lagrangian:

$$L^B = -\frac{1}{4} B_{\mu\nu}(x) B^{\mu\nu}(x) - \frac{1}{4} \sum_{i=1}^3 G_{\mu\nu}^{(i)}(x) G^{(i)\mu\nu}(x)$$

$$\rightarrow L^B = \underbrace{-\frac{1}{4} B_{\mu\nu}(x) B^{\mu\nu}(x) - \frac{1}{4} \sum_{i=1}^3 F_{\mu\nu}^{(i)}(x) F^{(i)\mu\nu}(x)}_{L_0^B}$$

$$+ \underbrace{g \sum_{i,j,k=1}^3 \varepsilon_{ijk} W^{(j)\mu}(x) W^{(k)\nu}(x) \partial^\mu W^{(k)\nu}(x) - \frac{1}{4} \sum_{i,j,k,l,m=1}^3 \varepsilon_{ijk} \varepsilon_{ilm} g^2 W^{(j)\mu}(x) W^{(k)\nu}(x) W^{(l)\mu}(x) W^{(m)\nu}}_{L_{SI}^B}$$

L_0^B = Free term

L_{SI}^B = Self-Interaction term

Gauge Boson Terms - III

65

Free term: Rewrite using $A^\mu, W^\mu, W^{\dagger\mu}, Z^\mu$:

$$L_0^B = -\frac{1}{4} F_{\mu\nu}(x) F^{\mu\nu}(x) - \frac{1}{2} F_{\mu\nu}^W(x) F^{W\dagger\mu\nu}(x) - \frac{1}{4} Z_{\mu\nu}(x) Z^{\mu\nu}(x)$$

Field tensors:

$$F_{\mu\nu}(x) = \partial_\mu A_\nu(x) - \partial_\nu A_\mu(x) \quad \text{Coupled to EM current}$$

$$\left. \begin{aligned} F_{\mu\nu}^W(x) &= \partial_\mu W_\nu(x) - \partial_\nu W_\mu(x) \\ F^{W\dagger\mu\nu}(x) &= \partial^\mu W^{\dagger\nu}(x) - \partial^\nu W^{\dagger\mu}(x) \end{aligned} \right\} \text{Coupled to Charged current}$$

$$Z^{\mu\nu}(x) = \partial^\mu Z^\nu(x) - \partial^\nu Z^\mu(x) \quad \text{Coupled to Neutral current}$$

Self-Interaction term: Similar to 3- and 4-gluons terms of QCD

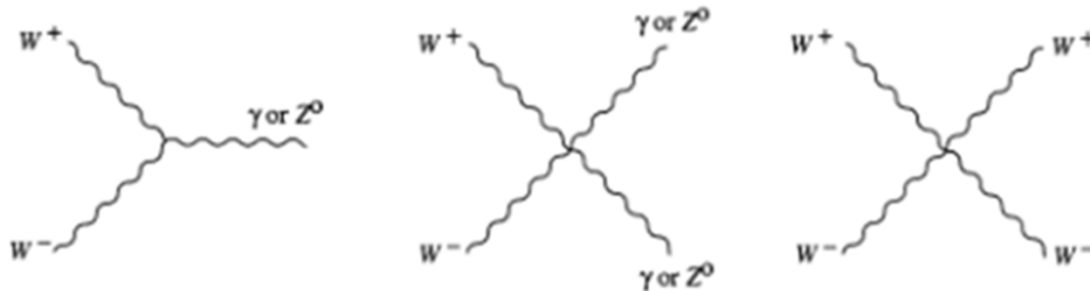

Mass - I

66

Massless leptons & gauge bosons not physical: Mass must be there

But: Putting 'by hand' a mass term in L would spoil gauge invariance

Gauge bosons:

$$m_W^2 W_\mu^\dagger W^\mu + \frac{1}{2} m_Z^2 Z_\mu Z^\mu$$

Take W as an example:

$$W_i^\mu \rightarrow W_i^\mu - \partial^\mu \omega_i(x) - g \varepsilon_{ijk} \omega_j(x) W_k^\mu \quad \text{infinitesimal parameters}$$

Then:

$$\begin{aligned} m_W^2 W_\mu^\dagger W^\mu &\rightarrow m_W^2 \left(W_i^{\dagger\mu} - \partial^\mu \omega_i(x) - g \varepsilon_{ijk} \omega_j(x) W_k^{\dagger\mu} \right) \left(W_i^\mu - \partial^\mu \omega_i(x) - g \varepsilon_{ijk} \omega_j(x) W_k^\mu \right) \\ &\rightarrow \neq m_W^2 W_\mu^\dagger W^\mu \end{aligned}$$

Mass - II

67

Leptons :

$$-m\bar{\psi}(x)\psi(x)$$

Write in terms of chiral parts :

$$-m\bar{\psi}(x)\psi(x) = -m\bar{\psi}(x)\left(\underbrace{P_R + P_L}_{=1}\right)\psi(x)$$

$$P_R = \frac{1 + \gamma_5}{2}, \quad P_L = \frac{1 - \gamma_5}{2}$$

$$\rightarrow -m\bar{\psi}(x)\left(\frac{1 + \gamma_5}{2} + \frac{1 - \gamma_5}{2}\right)\psi(x) = -m\bar{\psi}(x)\left(\left(\frac{1 + \gamma_5}{2}\right)^2 + \left(\frac{1 - \gamma_5}{2}\right)^2\right)\psi(x)$$

$$\rightarrow -m\bar{\psi}(x)\left(\frac{1 + \gamma_5}{2} + \frac{1 - \gamma_5}{2}\right)\psi(x) = -m\bar{\psi}_L(x)\psi_R(x) - m\bar{\psi}_R(x)\psi_L(x)$$

Not invariant under $SU(2)$:

L, R chiral parts live in different $SU(2)$ representations

Mass - III

68

Bottom line: *Any* mass term not invariant

Glashow model (1961): Put mass by hand
→ Gauge invariance lost, back to naive IVB

Finally, discover a subtle mechanism to give mass to physical states,
without spoiling gauge invariance:

Spontaneous Symmetry Breaking

Broad phenomenology, also remotely rooted in classical physics

SSB - I

69

Symmetries: Frequently approximate \rightarrow Broken

Breaking modes:

(a) Explicit breaking

$$H = H_0 + H_b$$

H_0 invariant

H_b non-invariant

Ex: Hydrogen atom in a magnetic field \mathbf{B}

$$H_0 = \frac{p^2}{2m} - \frac{Ze^2}{r} \quad \text{rotationally invariant}$$

$H_b = -\boldsymbol{\mu} \cdot \mathbf{B}$ invariant wrt rotations around \mathbf{B}

$\rightarrow H_0$ degeneracies removed by H_b

(b) Spontaneous breaking

H symmetric, ground state non symmetric

Ex: Ferromagnetism

$T > T_c$: $\mathbf{M} = 0 \rightarrow$ Dipoles randomly oriented

\rightarrow Rotational symmetry

$T < T_c$: $\mathbf{M} \neq 0 \rightarrow$ Dipoles pick some direction

$\rightarrow H$ degeneracies not removed

Ground state *degenerate*

SSB - II

70

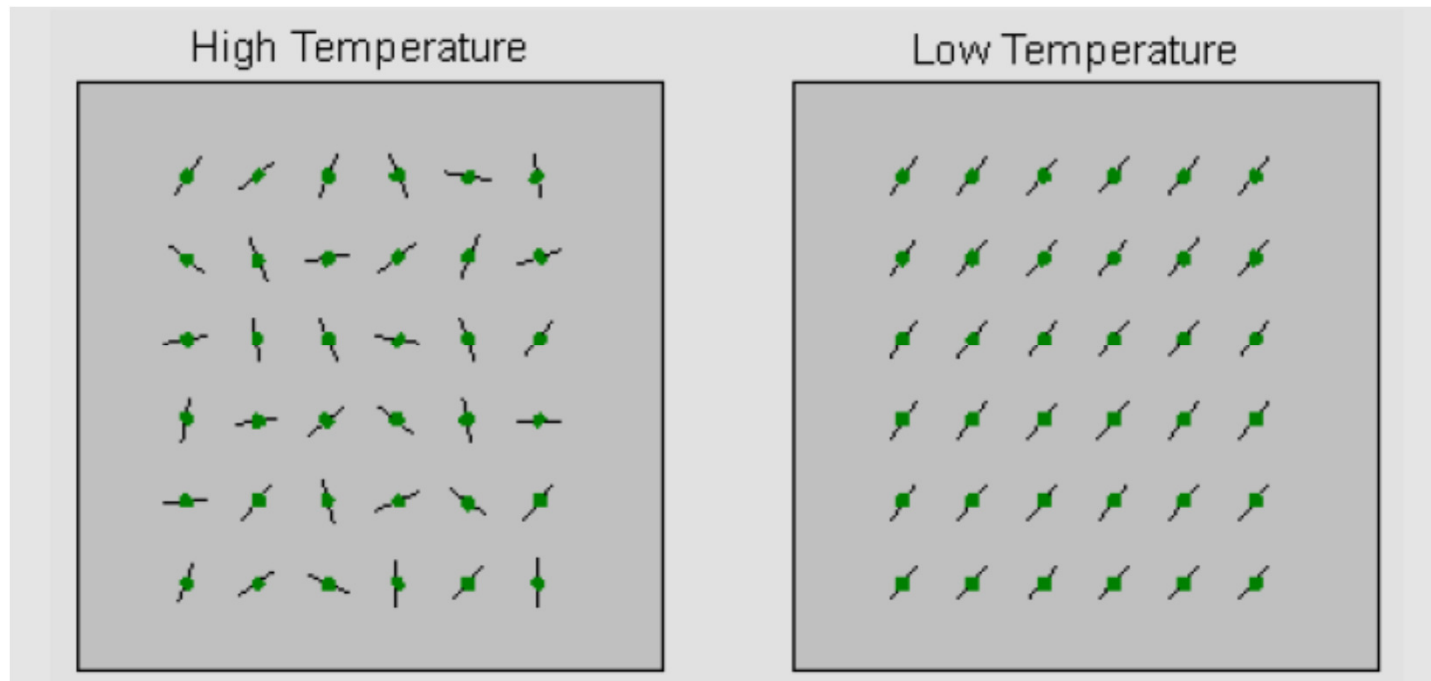

SSB - III

71

Take a first year classical mechanics exercise:
Bead sliding frictionless along a spinning hoop
Find equilibrium angle

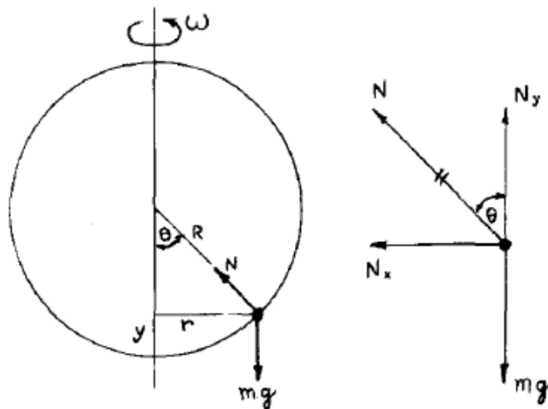

$$N = m\omega^2 R$$

$$N_y = N \cos \theta = m\omega^2 R \cos \theta = mg$$

$$\rightarrow \cos \theta_0 = \frac{g}{\omega^2 R}$$

Funny observation:

$$\text{Critical frequency: } \cos \theta_0 = 1 = \frac{g}{\omega_0^2 R}$$

For $\omega < \omega_0$: Different solution

$$\theta_1 = 0$$

SSB - IV

72

$$T = \frac{1}{2}mv^2 = \frac{1}{2}m(R^2\dot{\theta}^2 + \omega^2 R^2 \sin^2 \theta)$$

$$V = mgy = mgR(1 - \cos \theta)$$

$$L = T - V = \frac{1}{2}mR^2\dot{\theta}^2 + \frac{1}{2}m\omega^2 R^2 \sin^2 \theta - mgR(1 - \cos \theta)$$

$$L = \frac{1}{2}mR^2\dot{\theta}^2 - V_{\text{eff}}$$

Define effective potential, including centrifugal term :

$$V_{\text{eff}} \equiv -\frac{1}{2}m\omega^2 R^2 \sin^2 \theta + mgR(1 - \cos \theta) = mgR \left[(1 - \cos \theta) - \frac{\omega^2 R \sin^2 \theta}{2g} \right]$$

Define reduced effective potential, β parameter :

$$U \equiv \frac{V_{\text{eff}}}{mgR} = (1 - \cos \theta) - \frac{1}{2} \frac{\omega^2 R}{g} \sin^2 \theta$$

$$\beta \equiv \frac{\omega^2 R}{g}$$

$$\rightarrow U = (1 - \cos \theta) - \frac{1}{2}\beta \sin^2 \theta = 2 \sin^2 \frac{\theta}{2} - \frac{\beta}{2} (1 - \cos^2 \theta) = 2 \sin^2 \frac{\theta}{2} \left(1 - \beta \cos^2 \frac{\theta}{2} \right)$$

SSB - V

73

Find equilibrium angles, identify stable and unstable:

$$\frac{\partial U}{\partial \theta} = \sin \theta (1 - \beta \cos \theta) = 0$$

$$\rightarrow \begin{cases} \cos \theta_0 = \frac{1}{\beta} \\ \theta_1 = 0 \end{cases}$$

$$\frac{\partial^2 U}{\partial \theta^2} = \cos \theta - \beta \cos 2\theta$$

$$\left. \frac{\partial^2 U}{\partial \theta^2} \right|_{\theta=\theta_1} = 1 - \beta \quad \text{stable for } \beta < 1$$

$$\left. \frac{\partial^2 U}{\partial \theta^2} \right|_{\theta=\theta_0} = \beta - \frac{1}{\beta} \quad \text{stable for } \beta > 1$$

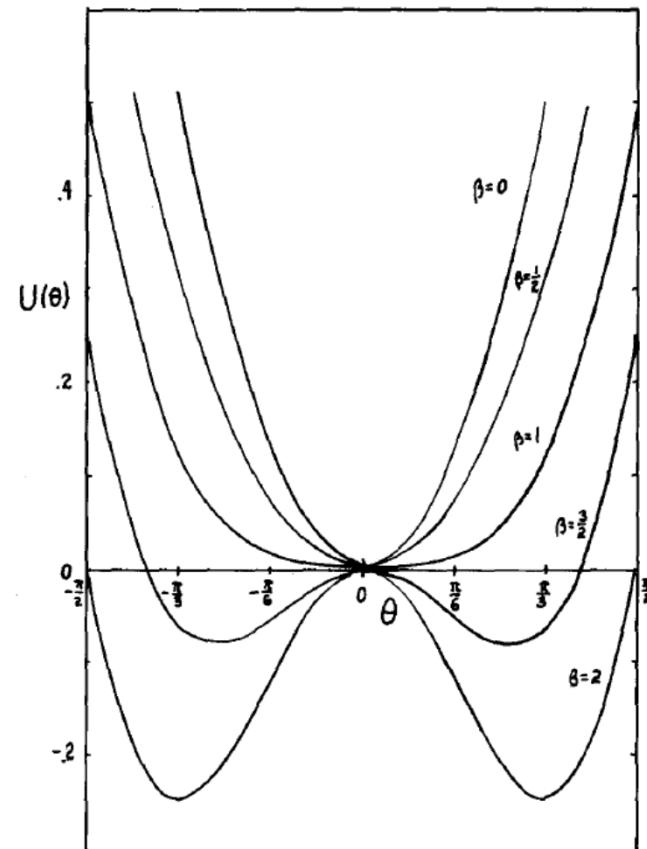

SSB - VI

74

Showing how shape of potential curve, equilibrium angle change with β

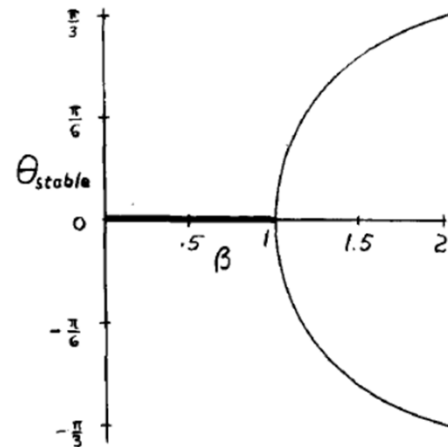
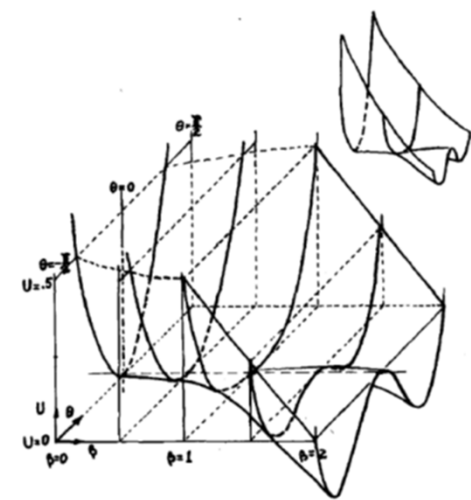

a) $\beta < 1 \rightarrow 1$ eq. angle

$\beta > 1 \rightarrow 2$ eq. angles: Cannot tell which one will be found

Reflection symmetry of V lost (\leftarrow spontaneously broken) in the solution of eq. of motion

b) Small oscillations around equilibrium angle:

$\beta < 1 \rightarrow OK$ Symmetrical wrt origin

$\beta > 1 \rightarrow KO$ Non symmetrical wrt origin

SSB - VII

75

Quantum Mechanics: Simple system with 1 degree of freedom:

$$L = \frac{1}{2}m\dot{x}^2 - \frac{1}{2}\lambda^2(x^2 - \eta^2)^2$$

$$V(x) = \frac{1}{2}\lambda^2(x^2 - \eta^2)^2$$

Potential: Parity symmetric

$$V(x) = V(-x)$$

Expand around $\pm\eta$ to quadratic terms only: Harmonic oscillator

$|+\rangle$ solution, centered on $+\eta$

$|-\rangle$ solution centered on $-\eta$

Naively:

Expect two degenerate ground states, both with undefined parity

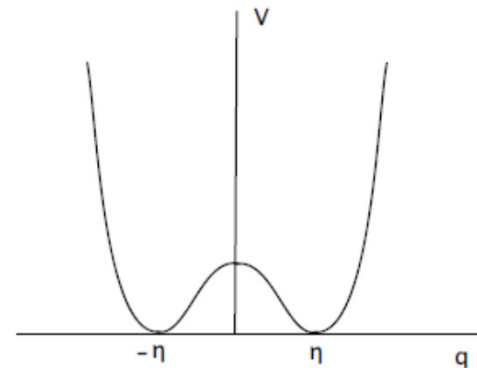

SSB - VIII

76

But:

H not diagonal in this basis

$$\langle + | H | + \rangle = \langle - | H | - \rangle = a, \langle + | H | - \rangle = \langle - | H | + \rangle = b$$

Physical reason : Tunneling through central barrier

→ Diagonalize, find:

Eigenstates	Energies
-------------	----------

$ S\rangle = +\rangle + -\rangle$	$a + b$
-------------------------------------	---------

$ A\rangle = +\rangle - -\rangle$	$a - b$
-------------------------------------	---------

$|S\rangle, |A\rangle$: Parity eigenstates

→ Degeneracy removed: Just 1 ground state

$$E_{ground} = a - |b|$$

SSB - IX

77

Field theory: Real scalar field

$$L = \frac{1}{2}(\partial_\mu \phi)^2 - V(\phi)$$

$$V(\phi) = \frac{1}{2}\mu^2\phi^2 + \frac{1}{4}\lambda^2\phi^4, \lambda > 0$$

Reflection symmetric: $V(\phi) = V(-\phi)$

V Minima:

$$\mu^2 > 0: \phi = 0$$

$$\mu^2 < 0: \phi = v = \pm \sqrt{-\frac{\mu^2}{\lambda}}$$

V Minima: Defining *vacuum* state (\leftarrow Cannot have less energy)

$\mu^2 > 0$: Vacuum (non degenerate) \equiv Zero field

$\mu^2 < 0$: Vacuum (degenerate!) = $v \neq$ Zero field !!

v = Vacuum Expectation Value (VEV) of ϕ

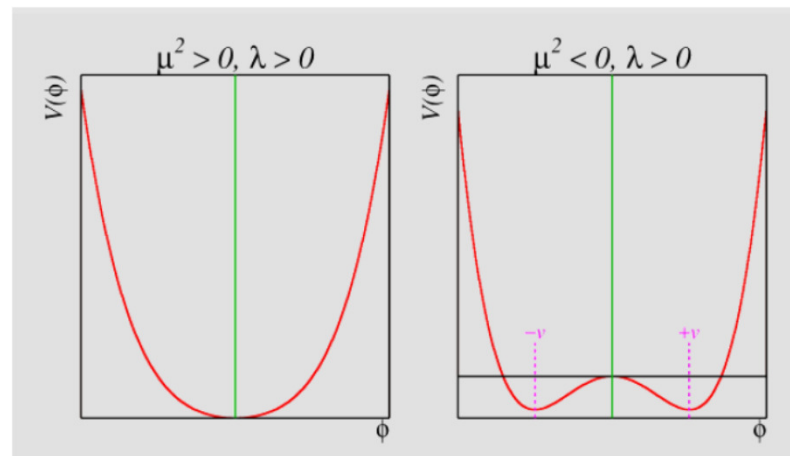

SSB - X

78

Choose vacuum state:

$$\langle \phi(x) \rangle_0 = v \quad \text{Spontaneous Symmetry Breakdown}$$

$$\text{Define: } \phi(x) = v + \eta(x)$$

$$\rightarrow L = \frac{1}{2}(\partial_\mu \eta)^2 - \lambda \left(v^2 \eta^2 - v \eta^3 - \frac{1}{4} \eta^4 \right) = \left[\frac{1}{2}(\partial_\mu \eta)^2 - \lambda v^2 \eta^2 \right] - \lambda v \eta^3 - \frac{1}{4} \lambda \eta^4$$

$$L = \frac{1}{2}(\partial_\mu \eta)^2 - \lambda v^2 \eta^2 + \text{higher powers of } \eta$$

\rightarrow Free Klein-Gordon equation \rightarrow Scalar quantum field

$$m^2 = 2\lambda v^2 \rightarrow m = \sqrt{-2\mu^2} > 0$$

[Observe: $\mu^2 < 0 \rightarrow$ Imaginary mass in original $L!$]

$$\text{KO: } L(\eta) \neq L(-\eta)$$

Reflection symmetry *spontaneously broken*

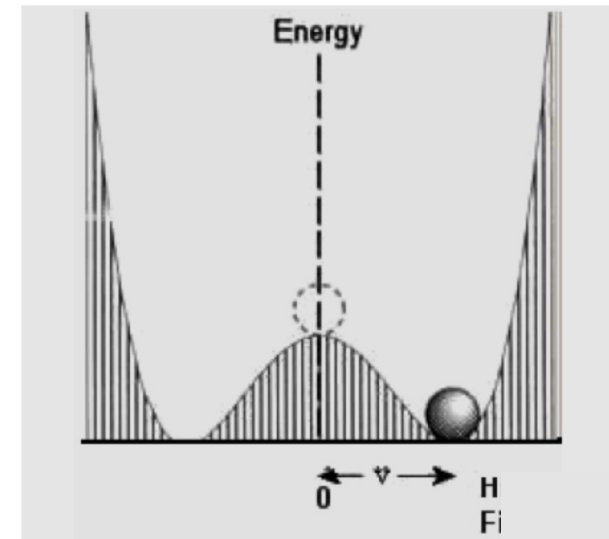

SSB - XI

79

What makes the difference between a single degree of freedom system and a field?

1 degree of freedom: Vacuum not degenerate

← Tunneling

∞ degrees of freedom: Vacuum degenerate

← Tunneling not effective

Indeed, it can be shown that:

$A_{tunnel} \propto e^{-aV}$, V system volume

→ $A_{tunnel} \sim 0$ for a (infinite) field

SSB - XII

80

Field theory: Complex scalar field

$$\phi = \frac{1}{\sqrt{2}}(\phi_1 + i\phi_2), \phi^* = \frac{1}{\sqrt{2}}(\phi_1 - i\phi_2)$$

$$L = (\partial_\mu \phi)(\partial^\mu \phi)^* - V(\phi)$$

$$V(\phi) = \mu^2 \phi^* \phi + \lambda (\phi^* \phi)^2, \lambda > 0, \mu^2 < 0$$

$U(1)$ symmetric: $\phi \rightarrow \phi' = e^{i\alpha} \phi$

Observe: $U(1)$ continuous symmetry

V Minima:

$$\mu^2 < 0: \phi_1^2 + \phi_2^2 = -\frac{\mu^2}{\lambda}$$

→ Vacuum infinitely degenerate

Choose vacuum = $(v, 0)$

→ $U(1)$ symmetry spontaneously broken

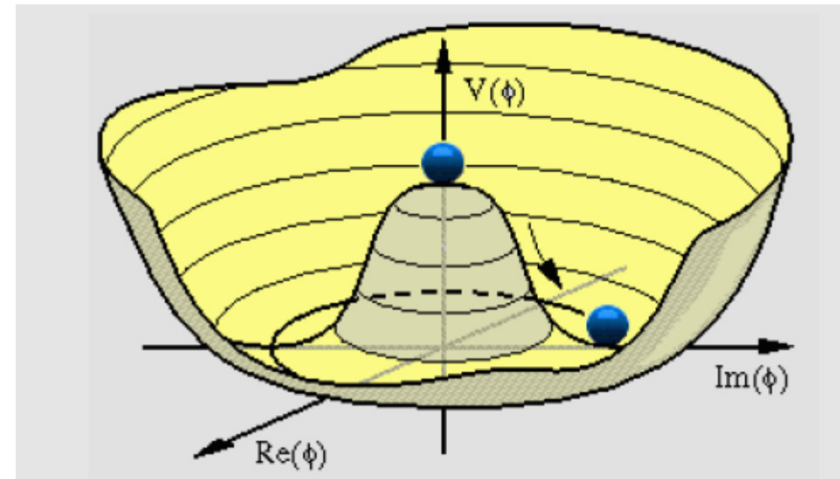

SSB - XIII

81

Define:

$$\phi(x) = \frac{1}{\sqrt{2}} [v + \xi(x) + i\eta(x)]$$

$$L = \frac{1}{2} [(\partial_\mu \xi)^2 + (\partial_\mu \eta)^2] + \mu^2 \eta^2 + \text{higher powers of } \eta$$

Free Klein-Gordon equations for (ξ, η)

But: "Kinetic energy" terms for both ξ, η ; Mass term only for η

→ η field excitations: *massive* scalar particles

→ ξ field excitations: *massless* scalar particles, aka *Goldstone Bosons*

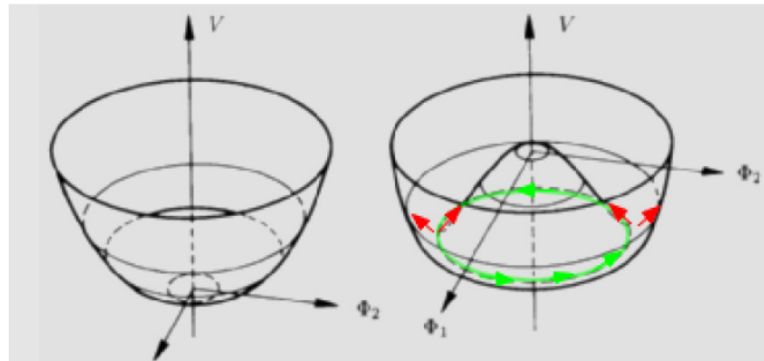

SSB - XIV

82

SSB of a continuous, global (\leftarrow non local) symmetry

$\rightarrow \infty$ degenerate vacuum states

Symmetry generators transform any vacuum state into another one

Indeed, for a non-degenerate vacuum: $\langle \phi \rangle_0$ Invariant under G

$\rightarrow e^{i\alpha G} \langle \phi \rangle_0 \simeq (1 + i\alpha G) \langle \phi \rangle_0 = \langle \phi \rangle_0 \leftrightarrow G \langle \phi \rangle_0 = 0$

$\rightarrow G$ does annihilate a non-degenerate vacuum

\rightarrow Goldstone Theorem:

n generators not annihilating the vacuum \rightarrow Appearance of n massless scalars

Also called *Goldstone bosons*

Example from condensed matter physics:

Ferromagnet \rightarrow Rotational symmetry lost \rightarrow Spin waves = Goldstones

Higgs Mechanism - I

83

Would seem to definitely destroy our hint of a Standard Model:

3 + 1 massless gauge bosons, only one observed

4 massless scalar bosons, none observed

Local gauge invariance + SSB: Higgs mechanism, evading Goldstone's theorem

Simple, yet subtle way of giving mass to gauge bosons

without spoiling gauge invariance (and renormalizability)

Example by Higgs :

$U(1)$ gauge group, require *local* symmetry:

Gauge vector boson A_μ to be introduced, coupling to some current as usual

Now: Add "sombbrero" potential for a complex, scalar field $\phi = \phi_1 + i\phi_2$

$$L = \underbrace{\left[(\partial_\mu - ieA_\mu) \phi^* \right] \left[(\partial^\mu + ieA^\mu) \phi \right]}_{EM \text{ interaction of (charged) } \phi} - \frac{1}{4} F_{\mu\nu} F^{\mu\nu} - \mu^2 \phi^* \phi - \lambda (\phi^* \phi)^2 + \underbrace{\dots}_{\text{Current-field interaction etc}}$$

As found before:

Degenerate vacuum state \rightarrow SSB picks as vacuum state $(v, 0)$

Higgs Mechanism - II

84

$$\rightarrow \phi = v + \eta_1 + i\eta_2$$

L written in terms of η_1, η_2 :

Upon quantization, 2 scalar particles $\rightarrow m_1 = \sqrt{2\lambda v^2}, m_2 = 0$

Plugging $\phi = v + \eta_1 + i\eta_2$ into L :

$$L = \frac{1}{2}(\partial_\mu \eta_1)(\partial^\mu \eta_1) - \frac{1}{2} \overbrace{2\lambda v^2}^{m_1^2} \eta_1^2 + \frac{1}{2}(\partial_\mu \eta_2)(\partial^\mu \eta_2) \\ + \frac{1}{2} \overbrace{(ev)^2}^{m_V^2} A^\mu A_\mu - \frac{1}{4} F_{\mu\nu} F^{\mu\nu} + \underbrace{evA^\mu \partial_\mu \eta_2}_{??} + \dots$$

Massive vector!

Attempting to understand L :

Massive vector field A^μ + Massive scalar field η_1 + Massless scalar field η_2

Troubling term coupling A^μ and η_2

Higgs Mechanism - III

85

Use gauge invariance:

$$\begin{cases} \phi \rightarrow \phi' = e^{-ie\theta(x)} \phi \\ A^\mu \rightarrow A'^\mu = A^\mu + \partial_\mu \theta \end{cases}$$

Choose θ to make ϕ real: Then $\eta_2 \equiv 0$ (\leftarrow Unitary gauge)

$$\rightarrow L = \frac{1}{2} (\partial_\mu \eta_1) (\partial^\mu \eta_1) - \frac{1}{2} 2\lambda v^2 \eta_1^2 + \frac{1}{2} \overbrace{(ev)^2}^{M_V^2} A^\mu A_\mu - \frac{1}{4} F_{\mu\nu} F^{\mu\nu} + \dots$$

Massive vector!

Massive vector field A^μ + Massive scalar field η_1

Counting degrees of freedom:

$$\underbrace{2}_{A_\mu} + \underbrace{1+1}_\phi = \underbrace{3}_{A_\mu} + \underbrace{1}_{\eta_1} \quad \text{OK}$$

Standard picture:

By effect of a smart gauge transformation, the massless vector field A_μ has eaten the Goldstone boson η_2 to become massive

Higgs Mechanism - IV

86

Attempting to dissipate some misunderstandings likely to sneak in:

Mostly related to our naive perception of what is really a 'particle'

1) Where is the mass?

To identify mass terms in L : Not necessarily a trivial task

Key point: Particle content *only meaningful in perturbative expansion*

Example: $L = (\partial_\mu \phi)(\partial^\mu \phi)^* - (-\mu^2 \phi^* \phi) - \lambda(\phi^* \phi)^2, \lambda > 0, \mu^2 > 0$

$-\mu^2 \rightarrow$ Imaginary mass \rightarrow Nonsense \rightarrow ???

But: To use this form of L to extract Feynman rules, should expand around $|\phi| = 0$

Unstable extremum \rightarrow Can't make it

Rewrite by expanding around $\eta = 0$: $L = \frac{1}{2}(\partial_\mu \eta)^2 - \lambda \nu^2 \eta^2 + \dots$

Stable extremum \rightarrow OK

\rightarrow Particle content should be identified in this form

Higgs Mechanism - V

87

2) What's so special in unitary gauge?

Nothing: L invariant under local gauge transformations, including the one to unitary gauge:

→ L describe the same physics before and after the gauge transformation

But: Particle content much easier to extract in the unitary gauge

3) Disappearing Goldstones !?

Indeed: And re-appearing as extra degrees of freedom for massive gauge bosons

See comment above on the tricky business of defining what is a particle...

4) What decides which vacuum is selected among the many?

Not really relevant: Any choice yields identical results

5) Could we make it with the SM without SSB and all that complicated swapping of degrees of freedom?

Actually no: SSB is an *intrinsic* feature of certain quantum systems

More on Higgs field and particle later (last part of the lectures)

SM - I

88

Higgs mechanism fixes troublesome, massless gauge bosons in the unified EW interaction

Boson counting:

Local gauge symmetry $SU(2)_L \otimes U(1)_Y \rightarrow 4$ vector bosons

Will need 3 symmetries spontaneously broken to give mass to 3 weak bosons

Photon *is* massless

Extend Abelian Higgs model to non-Abelian gauge symmetry:

Introduce a doublet of complex, scalar fields:

$$\phi(x) = \begin{pmatrix} \phi^+(x) \\ \phi^0(x) \end{pmatrix}$$

$$\text{Assuming } y = 1 \rightarrow \begin{cases} Q[\phi^+(x)] = +1 \\ Q[\phi^0(x)] = 0 \end{cases}$$

SM - II

89

$SU(2)_L \otimes U(1)$ Gauge transformation of doublet:

$$\phi \rightarrow \phi' = \exp \left\{ -i \left[\frac{g}{2} \mathbf{a}(x) \cdot \boldsymbol{\tau} + \frac{g'}{2} y \theta(x) I \right] \right\} \phi$$

$SU(2)_L \otimes U(1)$ Covariant derivative:

$$D^\mu = \partial^\mu + i \left[\frac{g}{2} \boldsymbol{\tau} \cdot \mathbf{W}^\mu + \frac{g'}{2} y B^\mu \right]$$

→ Additional term to EW lagrangian:

$$L_H = D_\mu \phi^\dagger D^\mu \phi - \mu^2 \phi^\dagger \phi - \lambda (\phi^\dagger \phi)^2$$

Take $\mu^2 < 0$, $\lambda > 0$:

$$|\phi|_{\min}^2 = -\frac{\mu^2}{2\lambda} = \frac{v^2}{2} \rightarrow v = \sqrt{-\frac{\mu^2}{\lambda}}$$

Pick ground state (= vacuum) as

$$\langle \phi \rangle_0 = \begin{pmatrix} 0 \\ v \\ \sqrt{2} \end{pmatrix} \rightarrow \text{SSB of Electroweak gauge symmetry}$$

SM - III

90

Goldstone boson: Associated with each generator not annihilating the vacuum

Take generators of $SU(2)_L \otimes U(1)_Y$:

$$\tau_1 \langle \phi \rangle_0 = \begin{pmatrix} 0 & 1 \\ 1 & 0 \end{pmatrix} \frac{1}{\sqrt{2}} \begin{pmatrix} 0 \\ v \end{pmatrix} = \frac{1}{\sqrt{2}} \begin{pmatrix} v \\ 0 \end{pmatrix} \neq 0$$

$$\tau_2 \langle \phi \rangle_0 = \begin{pmatrix} 0 & -i \\ i & 0 \end{pmatrix} \frac{1}{\sqrt{2}} \begin{pmatrix} 0 \\ v \end{pmatrix} = -\frac{i}{\sqrt{2}} \begin{pmatrix} v \\ 0 \end{pmatrix} \neq 0$$

$$\tau_3 \langle \phi \rangle_0 = \begin{pmatrix} 1 & 0 \\ 0 & -1 \end{pmatrix} \frac{1}{\sqrt{2}} \begin{pmatrix} 0 \\ v \end{pmatrix} = \frac{1}{\sqrt{2}} \begin{pmatrix} 0 \\ -v \end{pmatrix} \neq 0$$

$$Y \langle \phi \rangle_0 = +1 \langle \phi \rangle_0 \neq 0$$

$$\text{But: } Q \langle \phi \rangle_0 = \frac{1}{2} (Y + \tau_3) \langle \phi \rangle_0 = 0$$

$\rightarrow \langle \phi \rangle_0 : U(1)_Q$ Invariant $\rightarrow U(1)_Q$ symmetry unbroken \rightarrow Photon stays massless

SM - IV

91

As before for the Higgs model, rewrite:

$$\phi = \frac{1}{\sqrt{2}} \begin{pmatrix} \sigma_1 + i\sigma_2 \\ v + \eta_1 + i\eta_2 \end{pmatrix}$$

$$\rightarrow V = -\frac{\mu^4}{4\lambda} + \lambda v^2 \eta_1^2 + \lambda v \eta_1 (\sigma_1^2 + \sigma_2^2 + \eta_1^2 + \eta_2^2) + \frac{\lambda}{4} (\sigma_1^2 + \sigma_2^2 + \eta_1^2 + \eta_2^2)^2$$

3 massless scalars: $\sigma_1, \sigma_2, \eta_2 \leftarrow$ The Goldstones

1 massive scalar: $\eta_1, m_{\eta_1} \equiv m_H = \sqrt{2\lambda v^2} \leftarrow$ The Higgs

Gauge transformation suitable to get rid of 3 Goldstones:

$$\phi \rightarrow \phi' = U\phi = U \frac{1}{\sqrt{2}} \begin{pmatrix} \sigma_1 + i\sigma_2 \\ v + \eta_1 + i\eta_2 \end{pmatrix} = \frac{1}{\sqrt{2}} \begin{pmatrix} 0 \\ v + \eta_1 \end{pmatrix}$$

$\rightarrow \begin{cases} SU(2)_L \text{ rotation of doublet to make it 'down'} \\ U(1)_Y \text{ re-phasing of doublet to make it real} \end{cases} \leftarrow \text{Unitary gauge}$

SM - V

92

Re-write gauge terms of L in the unitary gauge, in terms of the physical fields:

$$L_B + L_H$$

$$= -\frac{1}{4} F_{\mu\nu}(x) F^{\mu\nu}(x) \quad \text{Photon}$$

$$-\frac{1}{2} F_{\mu\nu}^W(x) F^{W\mu\nu}(x) + \frac{1}{2} m_W^2 W_\mu^\dagger W^\mu \quad W^\pm \text{ boson}$$

$$-\frac{1}{4} Z_{\mu\nu}(x) Z^{\mu\nu}(x) + \frac{1}{2} m_Z^2 Z_\mu Z^\mu \quad Z^0 \text{ boson}$$

$$+ (\partial_\mu \sigma)(\partial^\mu \sigma) - \frac{1}{2} m_H^2 \sigma^2 \quad H \text{ Higgs boson}$$

$$+ L_{BB}^I + L_{HH}^I + L_{HB}^I \quad \text{Gauge-Higgs, Higgs self-, Gauge self-interactions}$$

SM - VI

93

Finding the acquired mass of gauge bosons in terms of couplings and VEV of the Higgs field:

$$\left. \begin{aligned} m_{W^\pm} &= \frac{g}{2} \sqrt{-\frac{\mu^2}{\lambda}} \\ m_{Z^0} &= \frac{\sqrt{(g^2 + g'^2)}}{2} \sqrt{-\frac{\mu^2}{\lambda}} \end{aligned} \right\} \rightarrow m_{Z^0} = m_{W^\pm} \sqrt{1 + \frac{g'^2}{g^2}}$$

$$m_\gamma = 0$$

$$m_H = \sqrt{-2\mu^2} = ???$$

Model parameters v, λ and θ_W :

$$v = \sqrt{-\frac{\mu^2}{\lambda}}$$

$$\lambda = ???$$

$$g \sin \theta_W = g' \cos \theta_W = e$$

SM - VII

94

Lepton masses: Different mechanism required

→ Yukawa (scalar) coupling

Describing interaction between Dirac and scalar fields:

$V \approx g \bar{\Psi} \phi \Psi$, Static limit:

$$V = -\frac{g}{4\pi} \frac{e^{-\mu r}}{r}$$

$$L_{HL} = -g_l \left[\bar{\Psi}_l^L \Phi \psi_l^R + \bar{\psi}_l^R \Phi^\dagger \Psi_l^L \right] - \underbrace{g_{\nu_l}}_{=0 \text{ for massless neutrino}} \left[\bar{\Psi}_l^L \tilde{\Phi} \psi_{\nu_l}^R + \bar{\psi}_{\nu_l}^R \tilde{\Phi}^\dagger \Psi_l^L \right], \quad \tilde{\Phi} = \begin{pmatrix} \phi_b^* \\ -\phi_a^* \end{pmatrix}$$

In the unitary gauge:

$$L_{HL} = -\frac{1}{v} m_l \bar{\psi}_l \psi_l \sigma - \frac{1}{v} m_{\nu_l} \bar{\psi}_{\nu_l} \psi_{\nu_l} \sigma$$

Lepton masses in terms of model parameters:

$$m_l = \frac{v g_l}{\sqrt{2}}, m_{\nu_l} = \frac{v g_{\nu_l}}{\sqrt{2}}$$

SM - VIII

95

Model parameters:

$$g, g', -\mu^2, \lambda, g_l, g_{\nu_l}$$

Quite remarkably, get m_W, m_Z by measured constants:

$$\left\{ \begin{array}{l} \alpha = \frac{1}{137.04} \\ G_F = 1.166 \cdot 10^{-5} \text{ GeV}^{-2} \\ \sin^2 \theta_W = 0.23122 \end{array} \right.$$

$$\rightarrow m_W = 77.5 \text{ GeV}, m_Z = 88.4 \text{ GeV}$$

Experimental values:

$$m_W = 80.40 \text{ GeV}, m_Z = 90.19 \text{ GeV}$$

Difference originating from radiative corrections

Higgs:

$$m_H = \sqrt{-2\mu^2} = \sqrt{2\lambda v^2} \rightarrow ???$$

SM - IX

96

Relating model parameters to measured constants $e, G_F, \sin \theta_W$:

$$g = \frac{e}{\sin \theta_W}, \quad g' = \frac{e}{\cos \theta_W}$$

$$G_F = \frac{\sqrt{2}}{8} \left(\frac{g}{M_W} \right)^2 \rightarrow \frac{8G_F}{\sqrt{2}} = \left(\frac{g}{M_W} \right)^2 \rightarrow \frac{M_W}{g} = \sqrt{\frac{\sqrt{2}}{8G_F}}$$

$$\rightarrow M_W = \sqrt{\frac{\sqrt{2}g^2}{8G_F}} = \sqrt{\frac{\sqrt{2}e^2}{8G_F \sin^2 \theta_W}} = \frac{37.3}{\sin \theta_W} \text{ GeV}$$

$$M_Z = \frac{M_W}{\cos \theta_W} = \frac{37.3}{\sin \theta_W \cos \theta_W} \text{ GeV}$$

$$v = \frac{2M_W}{g} = 2 \sqrt{\frac{\sqrt{2}}{8G_F}} = \frac{1}{\sqrt{\sqrt{2}G_F}}$$

$$\rightarrow \frac{v}{\sqrt{2}} = \frac{1}{\sqrt{\sqrt{2}G_F}} \frac{1}{\sqrt{2}} = \frac{1}{\sqrt{\sqrt{8}G_F}} \approx 174 \text{ GeV} \rightarrow \langle \phi \rangle_0 = \begin{pmatrix} 0 \\ \frac{v}{\sqrt{2}} \end{pmatrix} \approx \begin{pmatrix} 0 \\ 174 \text{ GeV} \end{pmatrix} \text{ VEV of the Higgs field}$$

No clues on $\lambda \rightarrow$ No (direct) prediction of $M_H = \sqrt{2v^2\lambda}$

SM - X

97

Lepton-Gauge Boson vertexes:

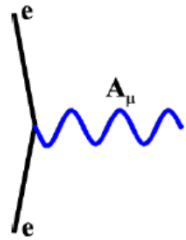

EM

$$-iQ_e \bar{e} \gamma^\mu e A_\mu$$

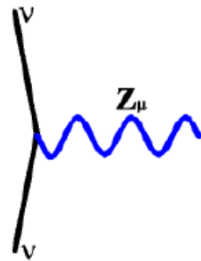
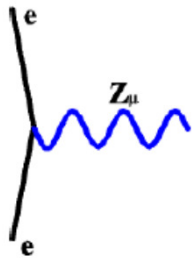

Neutral Current - NC

$$-i \frac{g}{4 \cos \theta_W} \bar{e} \gamma^\mu \left[2 \sin^2 \theta_W (1 + \gamma_5) + (2 \sin^2 \theta_W - 1)(1 - \gamma_5) \right] e Z_\mu$$

$$-i \frac{g}{4 \cos \theta_W} \bar{\nu} \gamma^\mu (1 - \gamma_5) \nu Z_\mu$$

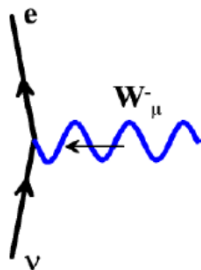
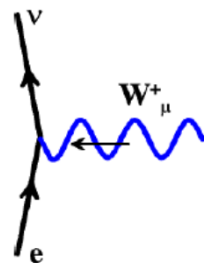

Charged Current - CC

$$-i \frac{g}{2\sqrt{2}} \bar{\nu} \gamma^\mu (1 - \gamma_5) e W_\mu^+$$

$$-i \frac{g}{2\sqrt{2}} \bar{e} \gamma^\mu (1 - \gamma_5) \nu W_\mu^-$$

SM - XI

98

Gauge bosons self-interaction vertexes:

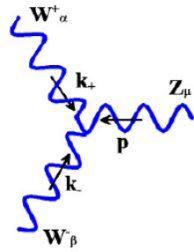
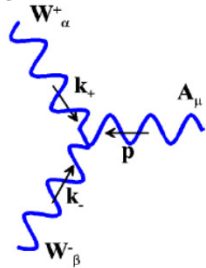

$$ig \sin \theta_W \left[g^{\alpha\beta} (k_+ - k_-)^\mu + g^{\alpha\mu} (p - k_+)^\beta + g^{\beta\mu} (k_- - p)^\alpha \right] W_\alpha^+ W_\beta^- A_\mu.$$

$$ig \cos \theta_W \left[g^{\alpha\beta} (k_+ - k_-)^\mu + g^{\alpha\mu} (p - k_+)^\beta + g^{\beta\mu} (k_- - p)^\alpha \right] W_\alpha^+ W_\beta^- Z_\mu.$$

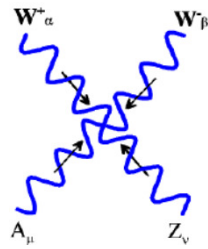
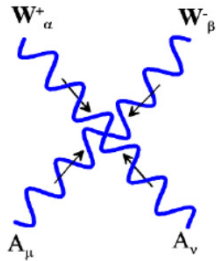

$$-ig^2 \sin^2 \theta_W \left[2g^{\mu\nu} g^{\alpha\beta} - g^{\mu\alpha} g^{\nu\beta} - g^{\mu\beta} g^{\alpha\nu} \right] \times W_\alpha^+ W_\beta^- A_\mu A_\nu,$$

$$-ig^2 \sin \theta_W \cos \theta_W \left[2g^{\mu\nu} g^{\alpha\beta} - g^{\mu\alpha} g^{\nu\beta} - g^{\mu\beta} g^{\alpha\nu} \right] W_\alpha^+ W_\beta^- A_\mu Z_\nu.$$

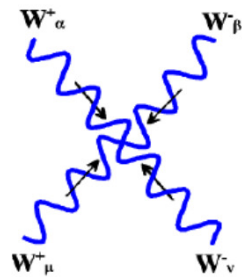
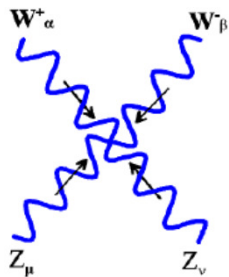

$$-ig^2 \cos^2 \theta_W \left[2g^{\mu\nu} g^{\alpha\beta} - g^{\mu\alpha} g^{\nu\beta} - g^{\mu\beta} g^{\alpha\nu} \right] W_\alpha^+ W_\beta^- Z_\mu Z_\nu,$$

$$-ig^2 \left[2g^{\mu\nu} g^{\alpha\beta} - g^{\mu\alpha} g^{\nu\beta} - g^{\mu\beta} g^{\alpha\nu} \right] W_\alpha^+ W_\beta^- W_\mu^+ W_\nu^-.$$

SM - XII



Higgs vertexes:

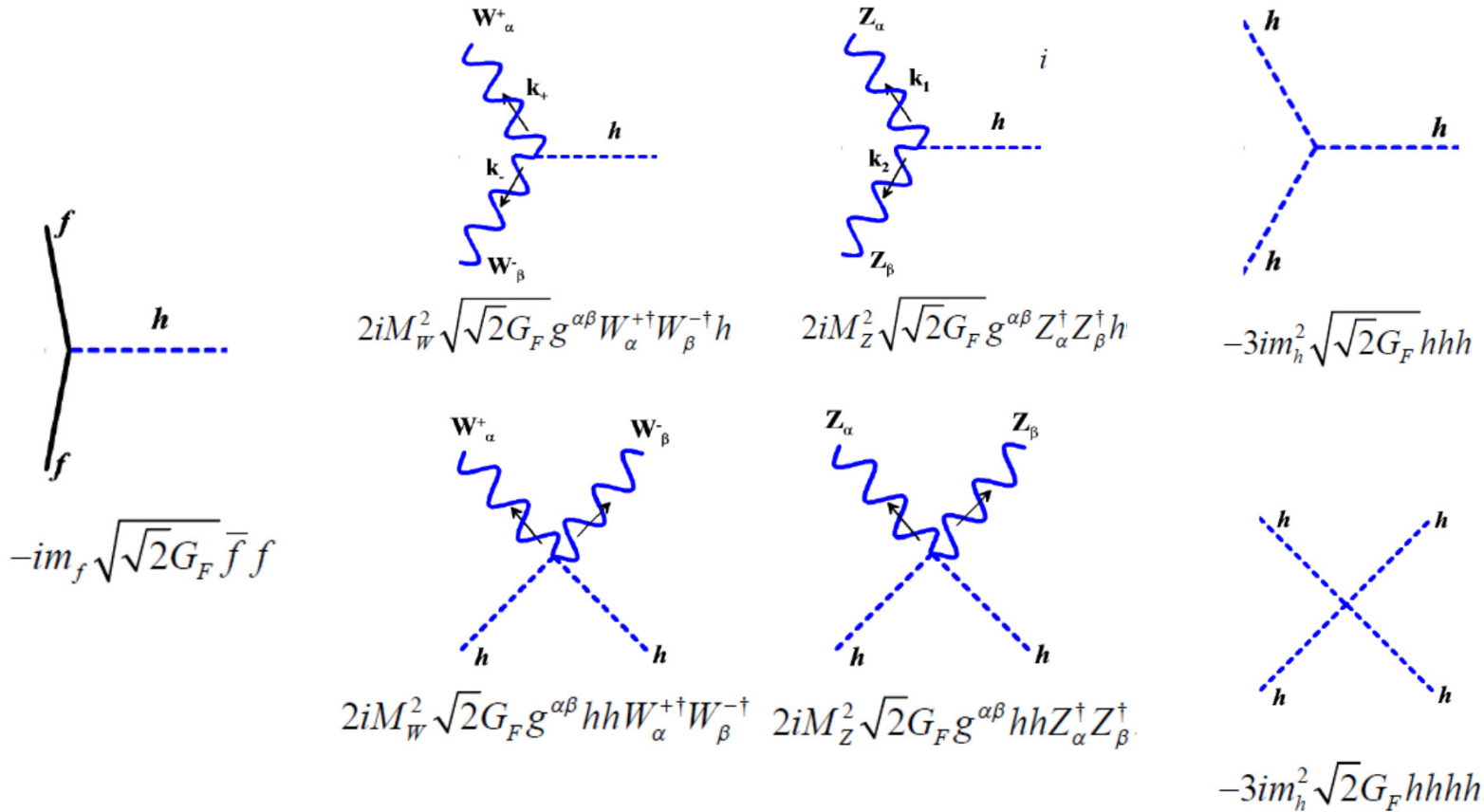

SM - XIII

100

Extension to 2nd, 3rd lepton family: Straightforward

Will need $2+2 = 4$ new parameters (Yukawa couplings)

'Minimal' Standard Model:

Massless neutrinos $\rightarrow g_{\nu_i}^{(i)} = 0$

'Non Minimal' Standard Model:

Neutrino mixing (\leftarrow Require massive neutrinos, mixing matrix):

Account for observed neutrino oscillations

May indicate physics beyond Standard Model

Extension to 3 quark families: Similar to leptons

Will need 6 more parameters

Will require CKM 'flavor rotation' (see later)

Strong interaction effects

} Flavor physics

SM - XIV

Fermion electroweak quantum numbers:

helicity	Generations			Quantum Numbers		
	1.	2.	3.	Q	T_3	Y_W
L	$\begin{pmatrix} \nu_e \\ e \end{pmatrix}_L$	$\begin{pmatrix} \nu_\mu \\ \mu \end{pmatrix}_L$	$\begin{pmatrix} \nu_\tau \\ \tau \end{pmatrix}_L$	0 -1	1/2 -1/2	-1 -1
	$\begin{pmatrix} u \\ d' \end{pmatrix}_L$	$\begin{pmatrix} c \\ s' \end{pmatrix}_L$	$\begin{pmatrix} t \\ b' \end{pmatrix}_L$	2/3 -1/3	1/2 -1/2	1/3 1/3
R	e_R	μ_R	τ_R	-1	0	-2
	u_R d_R	c_R s_R	t_R b_R	2/3 -1/3	0 0	4/3 -2/3

Neutral Currents Discovery - I

102

Predicted by Glashow-Salam-Weinberg model ('60s)

Not really accepted for a long time:

Mostly because of strong suppression of strangeness changing decays like:

$$K^0 \rightarrow \mu^+ \mu^- \quad BR < 10^{-8}$$

not accounted for. Compare:

$$K^+ \rightarrow \mu^+ \nu_\mu \quad BR \ 63.4 \%$$

Also because it was not clearly demonstrated that GSW was renormalizable

Two breakthroughs:

GIM prediction of charm to solve the $K^0 \rightarrow \mu^+ \mu^-$ puzzle ('70)

GSW model shown to be renormalizable by 't Hooft ('71)

→ Sudden wave of interest in gauge theories

Neutral Currents Discovery - II

103

Main interest = Prediction of new phenomena

Most shocking prediction of GSW: neutral currents, never seen before

→ Try to find neutral currents to validate GSW

Best opportunity :

High energy neutrino interactions

Larger cross sections

No EM background

Drawback:

Neutrino experiments difficult

Neutral Currents Discovery - III

104

Neutrino beams

Take 2 body decays of π, K obtained from a high energy proton machine

Kinematics:

$$\pi^\pm, K^\pm \rightarrow \mu^\pm + \nu_\mu^{(-)}$$

$$\beta, \gamma, M, |\mathbf{p}| \quad K, \pi \quad \text{LAB}$$

$$p^*, E_\mu^*, \theta_\mu^* \quad \mu \quad \text{CM}$$

$$p_\mu, E_\mu, \theta_\mu \quad \mu \quad \text{LAB}$$

$$|\mathbf{p}_\nu^*| = E_\nu^* = \frac{M_{\pi,K}^2 - m_\mu^2}{2M_{\pi,K}} \simeq \begin{cases} 30 \\ 236 \end{cases} \text{ MeV}$$

CM: Isotropic decay

$$\frac{dP}{d(\cos \theta^*)} = \frac{1}{2} \rightarrow \frac{dP}{dE} = \frac{dP}{d(\cos \theta^*)} \frac{d(\cos \theta^*)}{dE}$$

Neutral Currents Discovery - IV

105

Lorentz transform to LAB:

$$E = \gamma(E^* + \beta p^* \cos \theta^*) \rightarrow dE = \gamma \beta p^* d(\cos \theta^*) \rightarrow d(\cos \theta^*) = \frac{dE}{\gamma \beta p^*}$$

$$\rightarrow \frac{dP}{dE} = \frac{1}{2\gamma \beta p^*}$$

Flat distribution over wide interval:

$$\begin{cases} \gamma(1+\beta) E^* = \gamma(1+\beta) \frac{M_{\pi,K}^2 - m_\mu^2}{2M_{\pi,K}} & \text{max} \\ \gamma(1-\beta) E^* = \gamma(1-\beta) \frac{M_{\pi,K}^2 - m_\mu^2}{2M_{\pi,K}} & \text{min} \end{cases}$$

$$\frac{dN}{dE} = \frac{M_{\pi,K}}{\gamma \beta (M_{\pi,K}^2 - m_\mu^2)} = \frac{1}{\underbrace{\gamma \beta M_{\pi,K}}_{|\mathbf{p}|} \left(1 - \frac{m_\mu^2}{M_{\pi,K}^2}\right)} = \frac{1}{|\mathbf{p}| \left(1 - \frac{m_\mu^2}{M_{\pi,K}^2}\right)}$$

Neutral Currents Discovery - V

106

→ Broad LAB ν_μ energy distribution

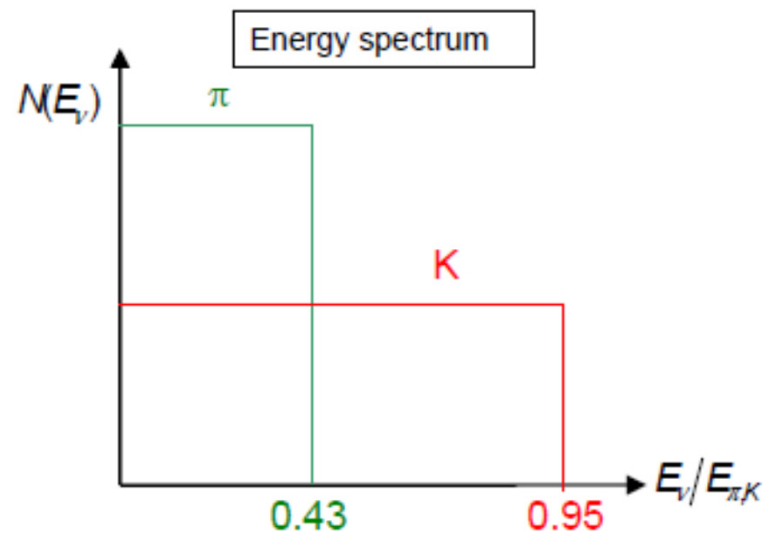

Neutral Currents Discovery - VI

107

- a) Narrow Band Beam: ν energy known, low intensity
Magnetic selection of a narrow π/K momentum window

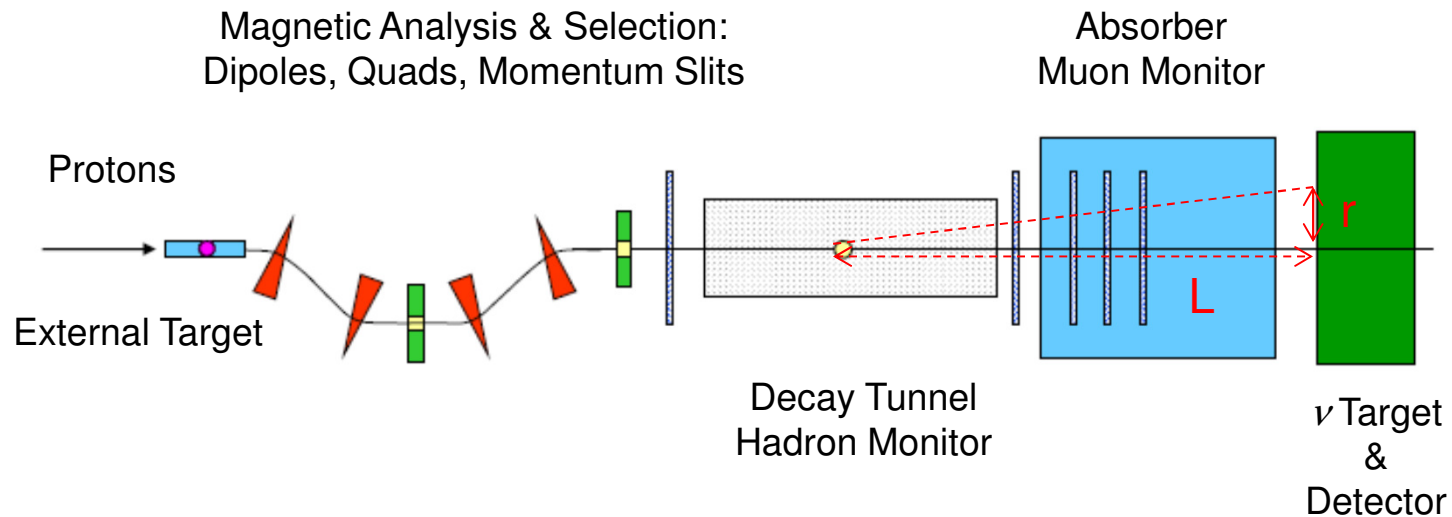

π/K momentum well defined

Beam/Detector geometry: $r \ll L$

Neutral Currents Discovery - VI

108

Measure ν energy by direction:

Exploit hadron beam \sim monocromaticity

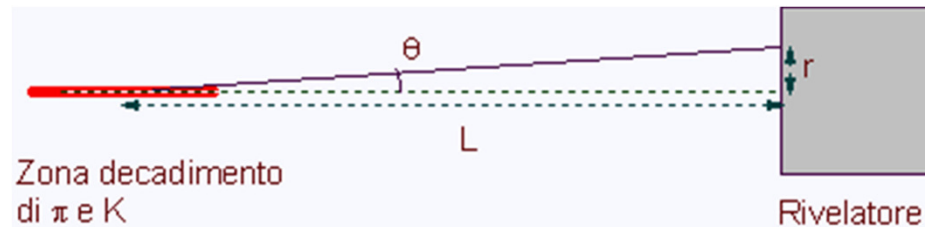

$$p_\pi = p_\mu + p_\nu \rightarrow p_\mu = p_\pi - p_\nu \rightarrow (p_\mu)^2 = (p_\pi - p_\nu)^2$$

$$m_\mu^2 = m_\pi^2 - 2p_\pi \cdot p_\nu \rightarrow m_\pi^2 - m_\mu^2 = 2(E_\pi E_\nu - \mathbf{p}_\pi \cdot \mathbf{p}_\nu)$$

$$E_\nu = \frac{m_{\pi,K}^2 - m_\mu^2}{2(E_{\pi,K} - p_{\pi,K} \cos \theta_\nu)} = \frac{m_\pi^2 - m_\mu^2}{2E_{\pi,K} (1 - \beta \cos \theta_\nu)}$$

$$\tan \theta_\nu = \frac{\sin \theta_\nu^*}{\gamma (\cos \theta_\nu^* + \beta)} \rightarrow \tan \theta_{\max} = \frac{\sin \frac{\pi}{2}}{\gamma \left(\cos \frac{\pi}{2} + \beta \right)} = \frac{1}{\beta \gamma} \approx \frac{1}{\gamma} = \frac{m_{\pi,K}}{|\mathbf{p}|} \ll 1$$

$$E_\nu = \frac{m_{\pi,K}^2 - m_\mu^2}{2E_{\pi,K} (1 - \beta \cos \theta)} \approx \frac{m_{\pi,K}^2 - m_\mu^2}{2E_{\pi,K} \left(1 - \beta \left(1 - \frac{\theta^2}{2} \right) \right)}$$

Neutral Currents Discovery - VII

109

$$E_\nu = \frac{m_{\pi,K}^2 - m_\mu^2}{2E_{\pi,K} \left(1 - \beta + \beta \frac{\theta^2}{2}\right)} = \frac{m_{\pi,K}^2 - m_\mu^2}{2E_{\pi,K} \left(\frac{1 - \beta^2}{1 + \beta} + \beta \frac{\theta^2}{2}\right)}$$

$$E_\nu \simeq \frac{m_{\pi,K}^2 - m_\mu^2}{2E_{\pi,K} \left(\frac{1 - \beta^2}{2} + \frac{\theta^2}{2}\right)}, \beta \approx 1$$

$$E_\nu = \frac{m_{\pi,K}^2 - m_\mu^2}{E_{\pi,K} \left(\frac{1}{\gamma^2} + \theta^2\right)} = \frac{m_{\pi,K}^2 \left(1 - \frac{m_\mu^2}{m_{\pi,K}^2}\right) E_{\pi,K}}{E_{\pi,K}^2 \left(\frac{1}{\gamma^2} + \theta^2\right)}$$

$$E_\nu = \frac{m_{\pi,K}^2 \left(1 - \frac{m_\mu^2}{m_{\pi,K}^2}\right) E_{\pi,K}}{\gamma^2 m_{\pi,K}^2 \left(\frac{1}{\gamma^2} + \theta^2\right)} = E_{\pi,K} \frac{\left(1 - \frac{m_\mu^2}{m_{\pi,K}^2}\right)}{\left(1 + \gamma^2 \theta^2\right)}$$

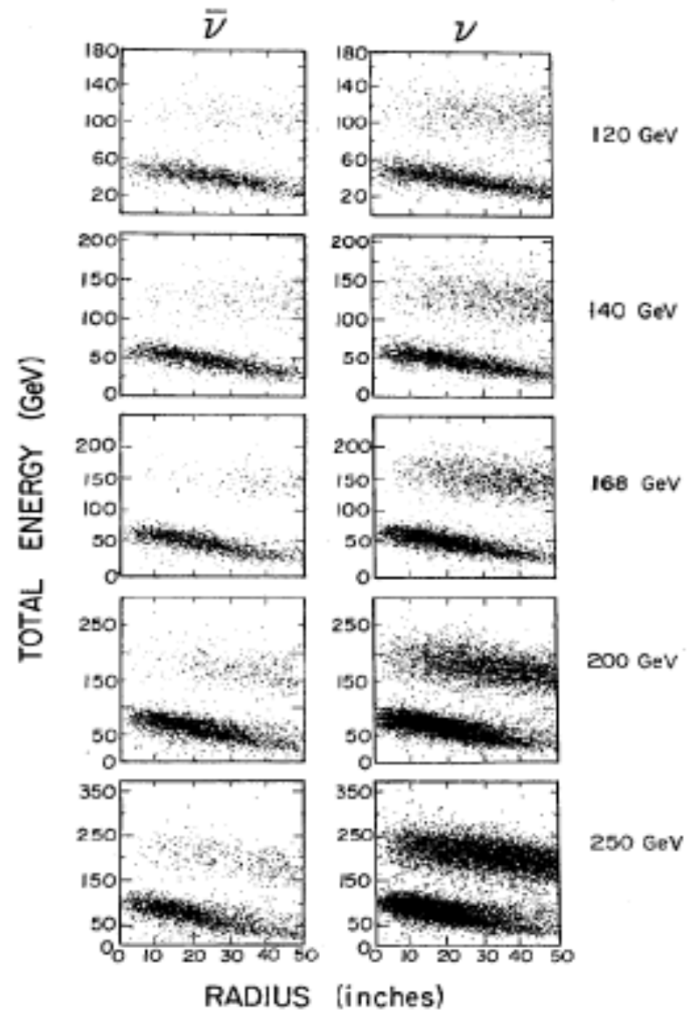

Neutral Currents Discovery - VIII

110

b) Wide Band Beam: ν energy unknown, high intensity

Replace magnetic selection by a special focussing device, suitable to make a low divergence hadron beam out of an uncollimated, divergent source: Van der Meer Horn

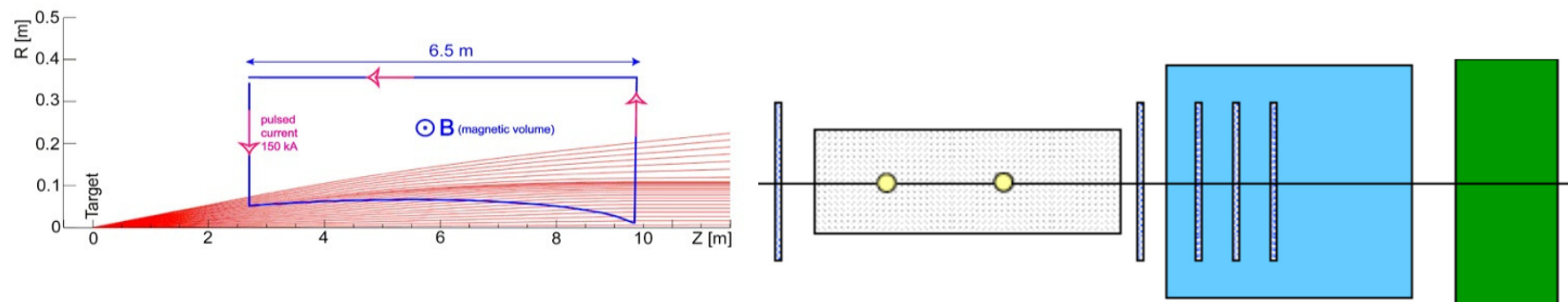

Collect a wide momentum window, focus into a narrow, intense beam

Neutral Currents Discovery - IX

2 conical (high) current sheets:

Equivalent to many trapezoidal current loops symmetrically placed around the axis
 → Circular magnetic field (red circumference)

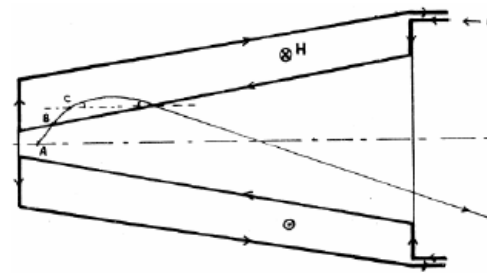
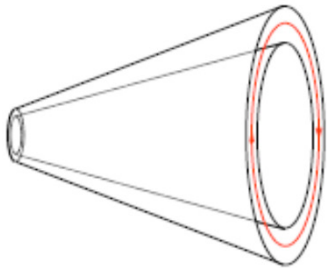

Trajectory in the B field: \sim Circular arc

$$|\mathbf{p}| = 0.3BR \begin{cases} p & \text{GeV} \\ B & \text{T} \\ R & \text{m} \end{cases}$$

Deflection after a path length l in the field:

$$\Delta\theta = \frac{\Delta l}{R} = 0.3B \frac{\Delta l}{|\mathbf{p}|}$$

Deflection should compensate $\langle p_T \rangle$

of hadrons coming out of the target:

$\langle p_T \rangle \sim p\Delta\theta \sim 0.2 \text{ GeV}$ at PS energies

$$\rightarrow 0.2 \text{ GeV} \sim |\mathbf{p}| \Delta\theta = 0.3B\Delta l$$

Simple guess:

$$B = \frac{\mu_0 I}{2\pi r} \rightarrow 0.2 \text{ GeV} \sim |\mathbf{p}| \Delta\theta \sim 0.3 \frac{\mu_0 I}{2\pi r} \Delta l$$

$$\rightarrow I \sim \frac{|\mathbf{p}| \Delta\theta 2\pi r}{0.3\mu_0 \Delta l} \sim 10^5 \text{ A!}$$

Neutral Currents Discovery - X

112

Narrow/Wideband beam spectra
SPS beam

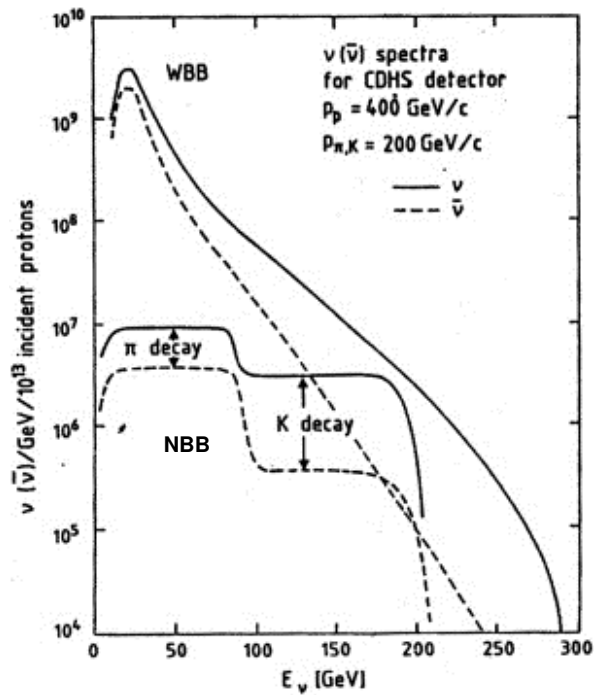

The Gargamelle horn

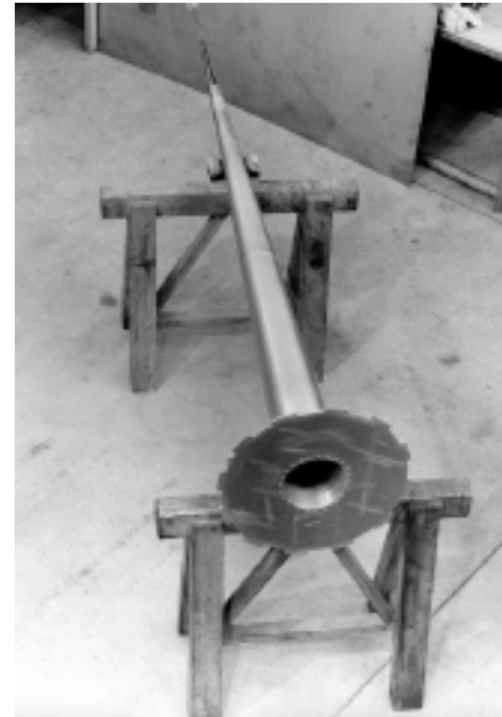

Neutral Currents Discovery - XI

113

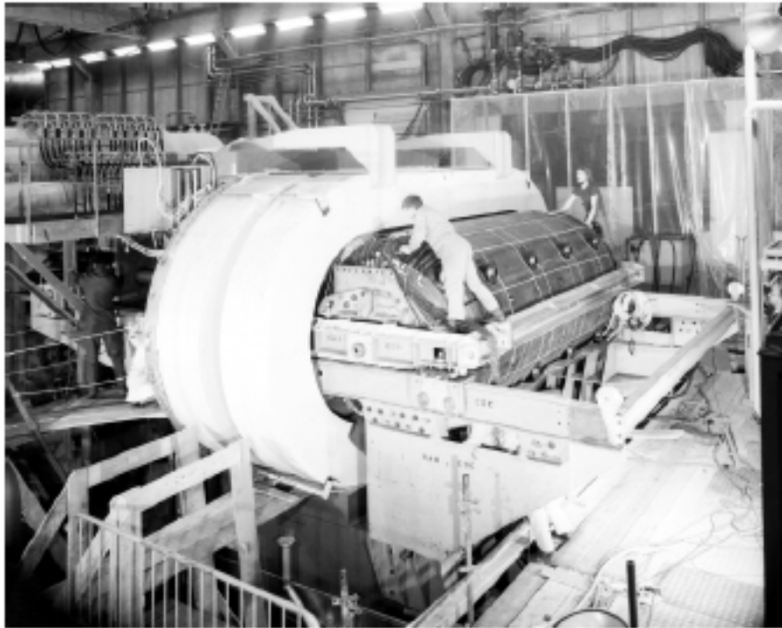

Length: 4.8 m
Diameter: 2 m
Liquid Freon: 12 m³

Neutral Currents Discovery - XII

114

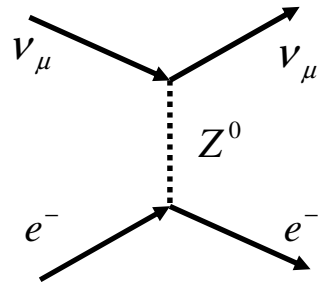

ν - e processes

Pure NC

$$\sigma_{\nu_\mu e^-}^{NC}(E) = \frac{G_F^2 s}{\pi} \left[\left(-\frac{1}{2} + \sin^2 \theta_W \right)^2 + \frac{1}{3} \sin^4 \theta_W \right]$$

$0.16 \times 10^{-41} E(\text{GeV}) \text{ cm}^2$

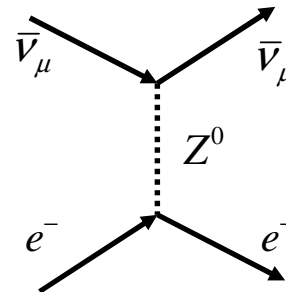

$$\sigma_{\bar{\nu}_\mu e^-}^{NC}(E) = \frac{G_F^2 s}{\pi} \left[\frac{1}{3} \left(-\frac{1}{2} + \sin^2 \theta_W \right)^2 + \sin^4 \theta_W \right]$$

$0.13 \times 10^{-41} E(\text{GeV}) \text{ cm}^2$

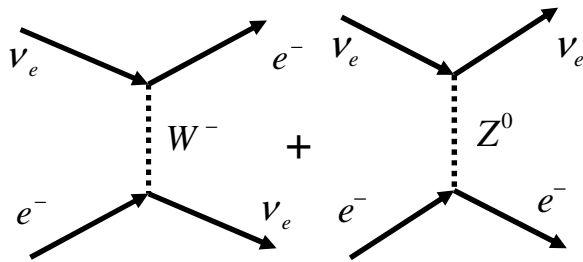

Interference
CC+NC

$$\sigma_{\nu_e e^-}^{CC+NC}(E) = \frac{G_F^2 s}{\pi} \left[\left(\frac{1}{2} + \sin^2 \theta_W \right)^2 + \frac{1}{3} \sin^4 \theta_W \right]$$

$0.96 \times 10^{-41} E(\text{GeV})$

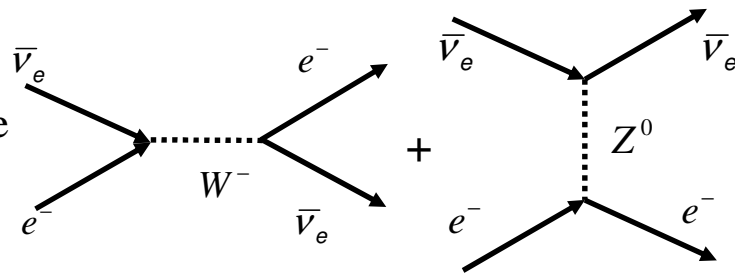

$$\sigma_{\bar{\nu}_e e^-}^{CC+NC}(E) = \frac{G_F^2 s}{\pi} \left[\frac{1}{3} \left(\frac{1}{2} + \sin^2 \theta_W \right)^2 + \sin^4 \theta_W \right]$$

$0.40 \times 10^{-41} E(\text{GeV}) \text{ cm}^2$

Neutral Currents Discovery - XIII

115

Effective couplings for several reactions

Reaction	ε	Electroweak theory		V-A theory	
		g_V	g_A	g_V	g_A
$\nu_\mu + e^- \rightarrow \nu_\mu + e^-$	+1	$-\frac{1}{2} + 2s^2$	$-\frac{1}{2}$	0	0
$\bar{\nu}_\mu + e^- \rightarrow \bar{\nu}_\mu + e^-$	-1	$-\frac{1}{2} + 2s^2$	$-\frac{1}{2}$	0	0
$\nu_e + e^- \rightarrow \nu_e + e^-$	+1	$+\frac{1}{2} + 2s^2$	$+\frac{1}{2}$	1	1
$\bar{\nu}_e + e^- \rightarrow \bar{\nu}_e + e^-$	-1	$+\frac{1}{2} + 2s^2$	$+\frac{1}{2}$	1	1
$\nu_\mu + e^- \rightarrow \mu^- + \nu_e$	+1	1	1	1	1

Neutral Currents Discovery - XIV

116

Differential cross sections:

$$y = 1 - \frac{E_\nu'}{E_\nu} \simeq \frac{E_e}{E_\nu} \quad \text{Bjorken } y$$

$$\frac{d\sigma_{\nu_\mu e}}{dy} = \frac{G_F^2 m_e}{2\pi} E_\nu \left[(g_V + g_A)^2 + (g_V - g_A)^2 (1-y)^2 + \frac{m_e}{E_\nu} (g_A^2 - g_V^2) y \right]$$

$$\frac{d\sigma_{\bar{\nu}_\mu e}}{dy} = \frac{G_F^2 m_e}{2\pi} E_\nu \left[(g_V - g_A)^2 + (g_V + g_A)^2 (1-y)^2 + \frac{m_e}{E_\nu} (g_A^2 - g_V^2) y \right]$$

$$\int_0^1 (1-y)^2 dy = \frac{1}{3}, \quad \int_0^1 y dy = \frac{1}{2}$$

Total cross sections:

$$\rightarrow \sigma_{\nu_\mu e} = \frac{G_F^2 m_e}{2\pi} E_\nu \left[(g_V + g_A)^2 + \frac{1}{3} (g_V - g_A)^2 + \frac{m_e}{E_\nu} \frac{1}{2} (g_A^2 - g_V^2) \right]$$

$$\rightarrow \sigma_{\bar{\nu}_\mu e} = \frac{G_F^2 m_e}{2\pi} E_\nu \left[(g_V - g_A)^2 + \frac{1}{3} (g_V + g_A)^2 + \frac{m_e}{E_\nu} \frac{1}{2} (g_A^2 - g_V^2) \right]$$

Neutral Currents Discovery - XV

117

First Gargamelle
leptonic neutral current event

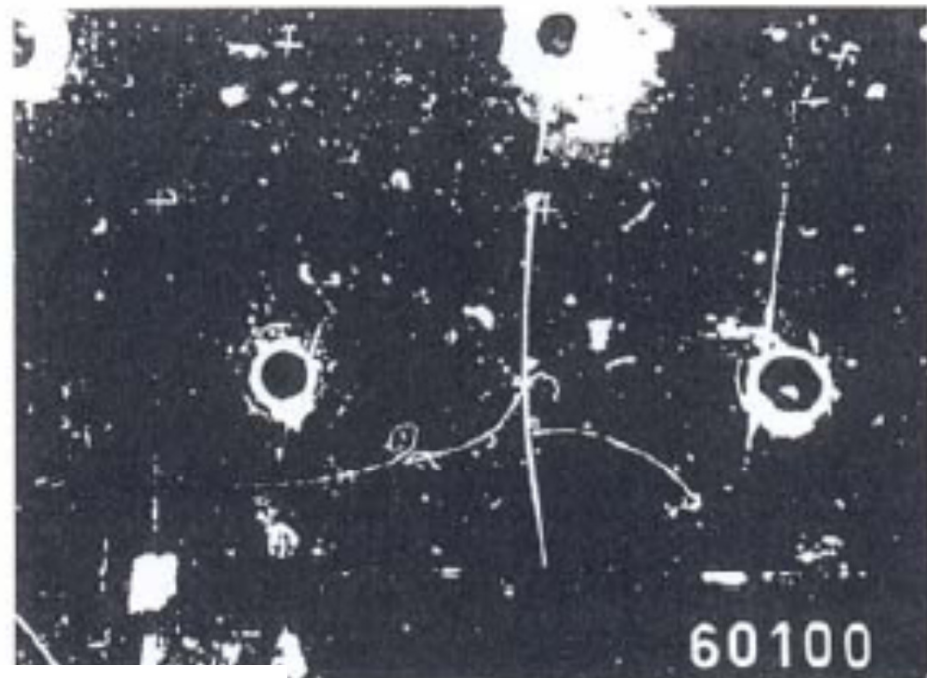

Neutraler Strom
= "schwaches Licht"

b)



Neutral Currents Discovery - XVI

118

(-)
 $\nu - q, \bar{q}$ processes

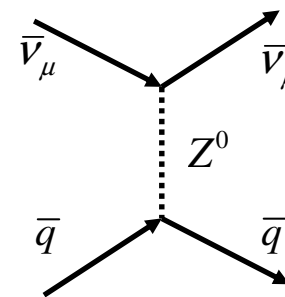
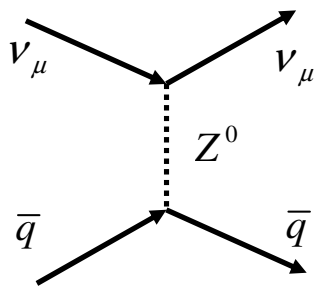
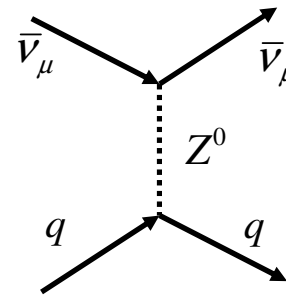
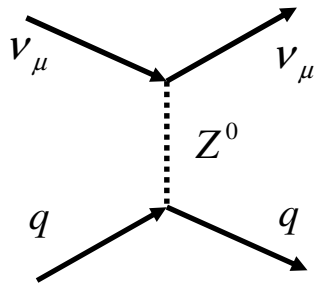

Neutral Currents Discovery - XVII

119

$$g_V = \frac{1}{2} - \frac{4}{3} \sin^2 \theta_W \quad g_A = \frac{1}{2} \quad u, c, t$$

$$g'_V = -\frac{1}{2} + \frac{4}{3} \sin^2 \theta_W \quad g'_A = \frac{1}{2} \quad d, s, b$$

$$g_L = \frac{1}{2} - \frac{2}{3} \sin^2 \theta_W \quad g_R = -\frac{2}{3} \sin^2 \theta_W \quad u, c, t$$

$$g'_L = -\frac{1}{2} + \frac{1}{3} \sin^2 \theta_W \quad g_R = \frac{1}{3} \sin^2 \theta_W \quad d, s, b$$

$$\frac{d\sigma_{\nu_\mu q}}{dy} = \frac{d\sigma_{\bar{\nu}_\mu \bar{q}}}{dy} = \frac{G_F^2 m_q}{2\pi} E_\nu \left[(g_V + g_A)^2 + (g_V - g_A)^2 (1-y)^2 + \frac{m_q}{E} (g_A^2 - g_V^2) y \right]$$

$$\frac{d\sigma_{\bar{\nu}_\mu q}}{dy} = \frac{d\sigma_{\nu_\mu \bar{q}}}{dy} = \frac{G_F^2 m_q}{2\pi} E_\nu \left[(g_V - g_A)^2 + (g_V + g_A)^2 (1-y)^2 + \frac{m_q}{E_\nu} (g_A^2 - g_V^2) y \right]$$

Neutral Currents Discovery - XVIII

120

$$\frac{d\sigma_{\nu\mu}^{(-)}}{dx dy} = \sum_q q(x) \frac{d\sigma_{\nu\mu q}^{(-)}}{dy} + \sum_{\bar{q}} \bar{q}(x) \frac{d\sigma_{\nu\mu\bar{q}}^{(-)}}{dy}$$

$$\rightarrow \frac{d\sigma_{\nu\mu N}}{dx dy} = \frac{G_F^2 m_N}{2\pi} x E_\nu \left[(g_L^2 + g_L'^2) (q + \bar{q} (1-y)^2) + (g_R^2 + g_R'^2) (\bar{q} + q (1-y)^2) \right]$$

$$\rightarrow \frac{d\sigma_{\bar{\nu}\mu N}}{dx dy} = \frac{G_F^2 m_N}{2\pi} x E_\nu \left[(g_R^2 + g_R'^2) (q + \bar{q} (1-y)^2) + (g_L^2 + g_L'^2) (\bar{q} + q (1-y)^2) \right]$$

$$R_\nu^N = \frac{\sigma_{NC}(\nu)}{\sigma_{CC}(\nu)} \quad R_{\bar{\nu}}^N = \frac{\sigma_{NC}(\bar{\nu})}{\sigma_{CC}(\bar{\nu})} \quad r = \frac{\sigma_{CC}(\bar{\nu})}{\sigma_{CC}(\nu)}$$

$$\rightarrow g_L^2 + g_L'^2 = \frac{R_\nu^N - r^2 R_{\bar{\nu}}^N}{1 - r^2} \quad g_R^2 + g_R'^2 = \frac{r(R_\nu^N - R_{\bar{\nu}}^N)}{1 - r^2}$$

Neutral Currents Discovery - XIX

121

Gargamelle
charged current

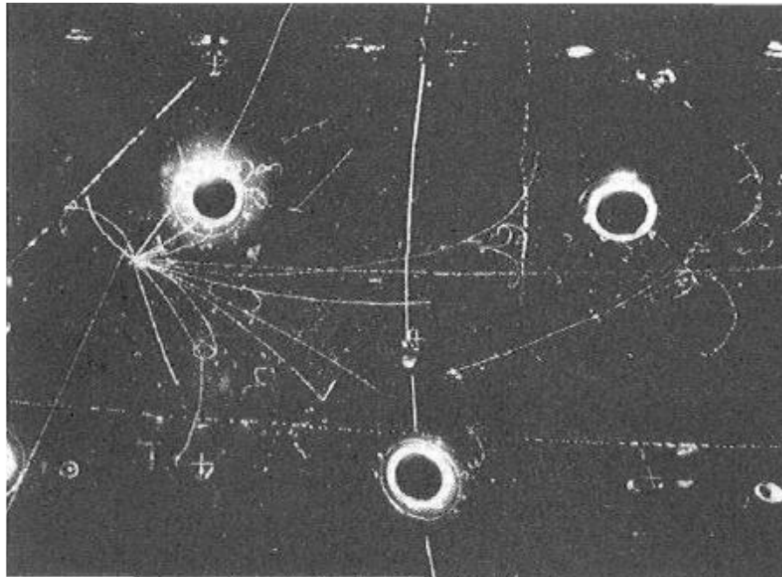

Gargamelle
hadronic neutral current event

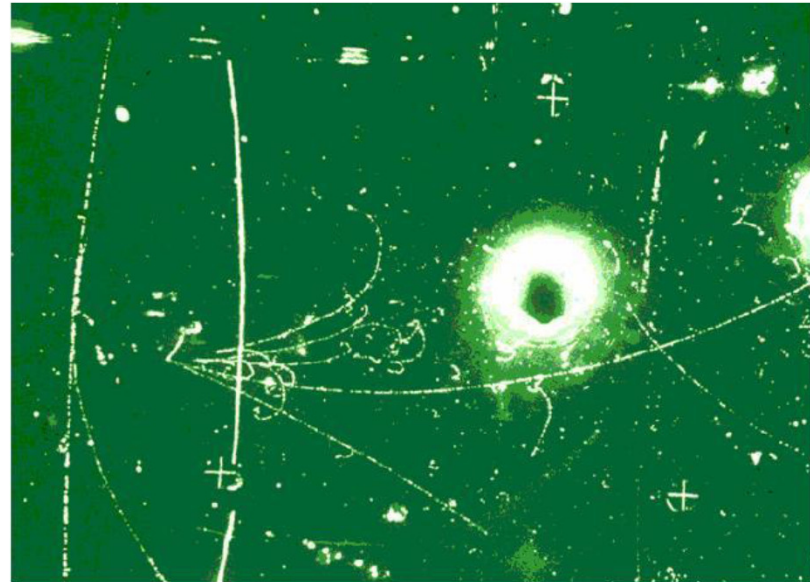

Neutral Currents Discovery - XX

122

Background

Result

$$\sin^2 \theta_w = 0.3 \div 0.4$$

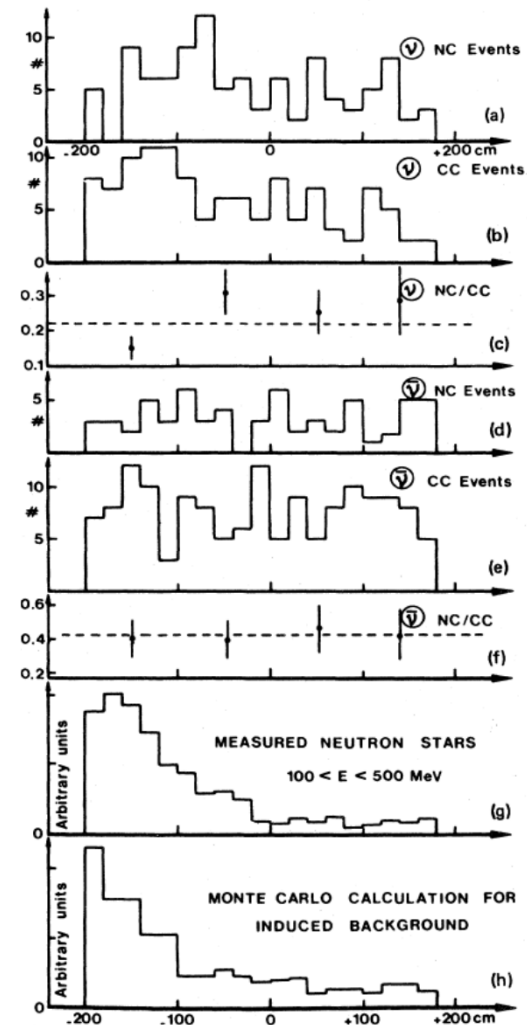

Neutral Currents Discovery - XXI

123

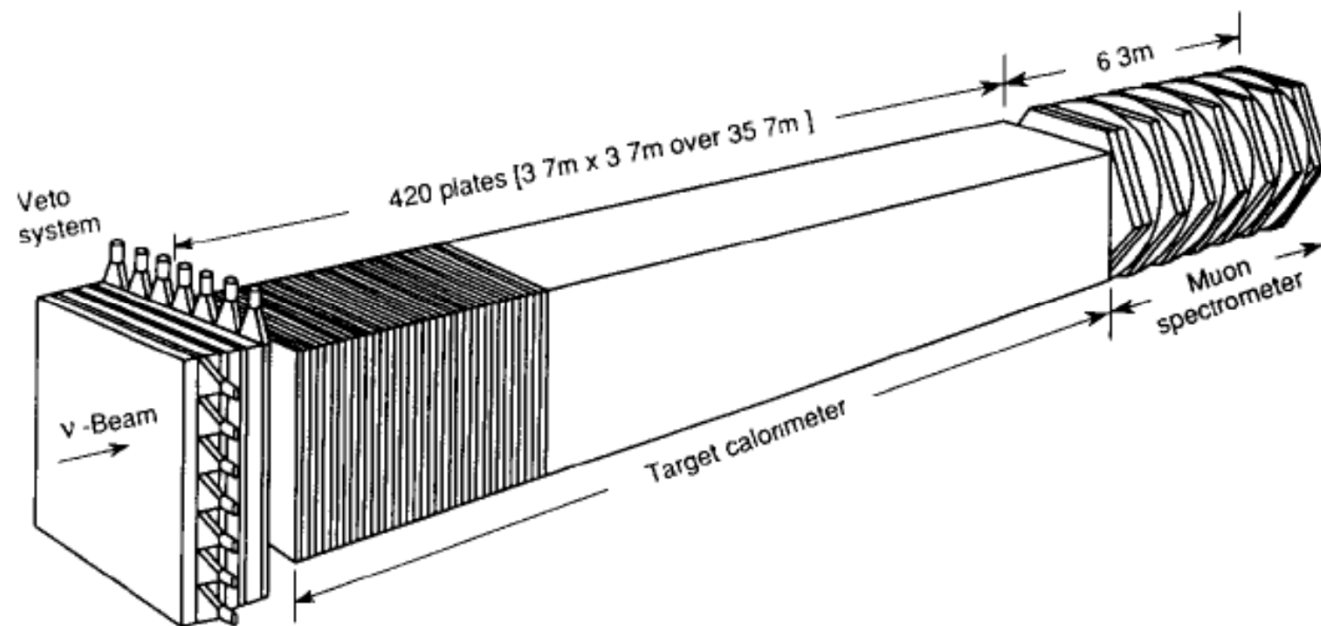

CHARM II

Neutral Currents Discovery - XXII

124

Experimental setup (CHARM II, 1987-1991)

electronic tracking detector

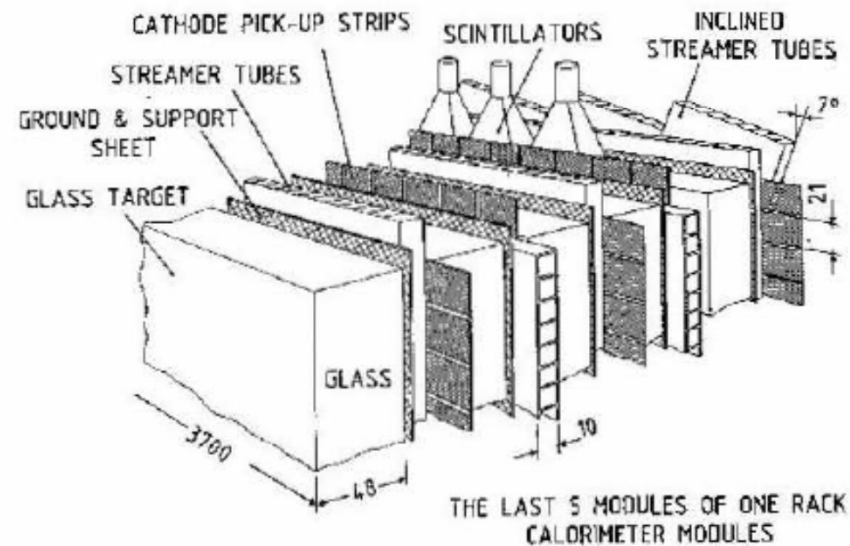
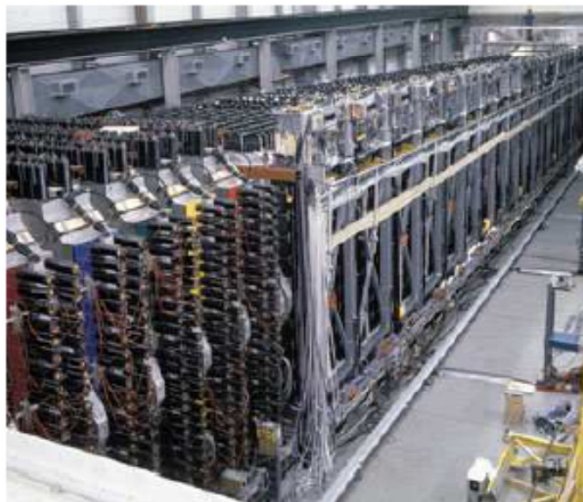

~ 700 t calorimeter, digital readout of energy and direction of produced particles

Neutral Currents Discovery - XXIII

125

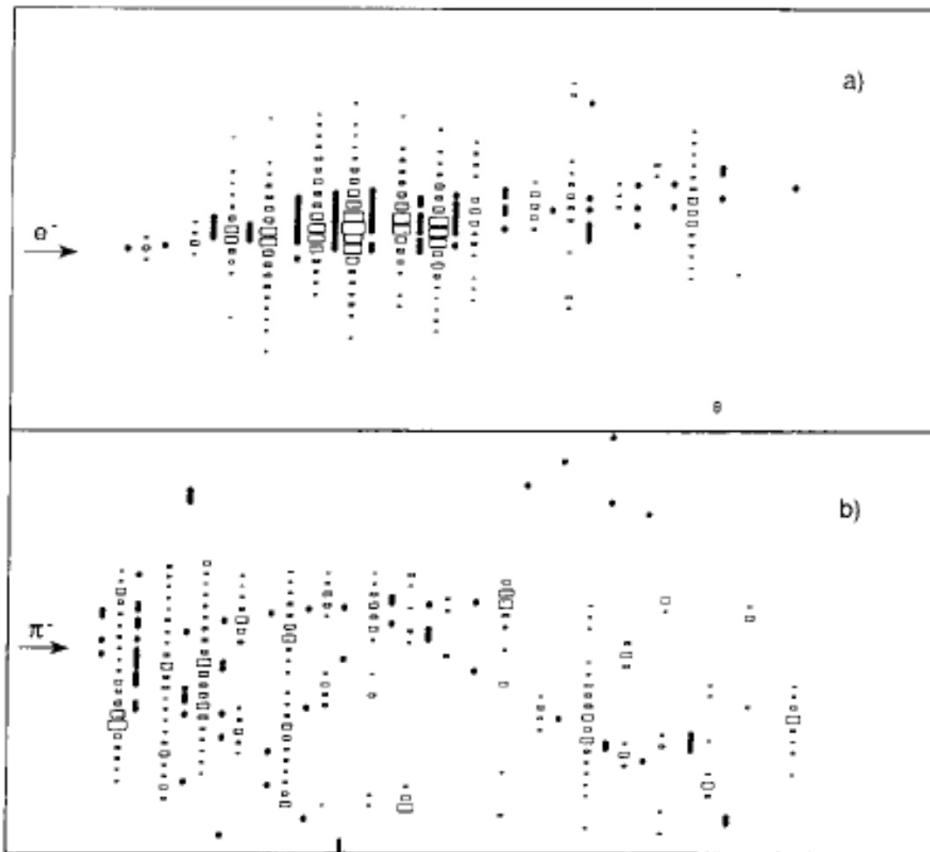

Electromagnetic shower

Hadronic shower

Neutral Currents Discovery- XXIV

126

CHARM II data

Problem: discrimination of the NC events (~ 2500 for $\nu_\mu e^-$ and $\bar{\nu}_\mu e^-$ each) from the dominant background (CC scattering, inelastic scattering)

Solution: in processes of interest $\nu_\mu e \rightarrow \nu_\mu e$ and $\bar{\nu}_\mu e^- \rightarrow \bar{\nu}_\mu e^-$ the value $E_e \theta_e^2$ is kinematically restricted to small values

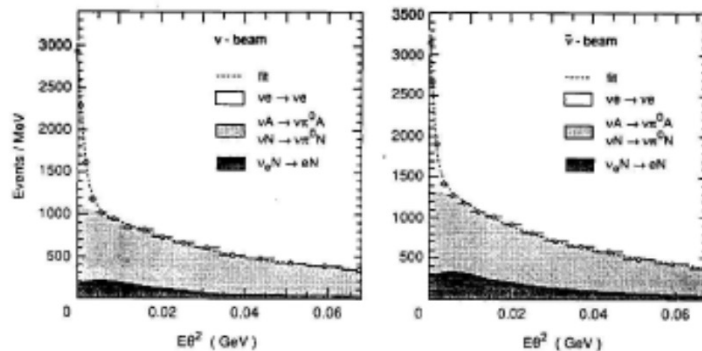

Phys.Lett. B335, 246 (1994)

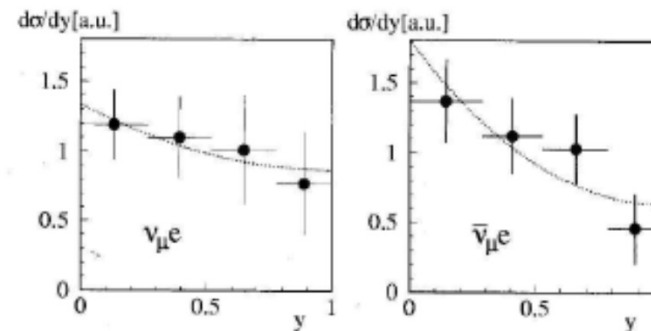

Phys.Lett. B302, 351 (1993)

$$\sin^2 \Theta_{\nu e} = 0.2324 \pm 0.0083$$

W & Z - I

127

Some reminiscences about photons...

$$\text{Free photons } (j^\mu = 0): \quad \square^2 A^\mu - \partial^\mu (\partial_\nu A^\nu) = j^\mu$$

Lorentz condition

$$\partial_\mu A^\mu = 0 \rightarrow \square^2 A^\mu = 0$$

$$\rightarrow A^\mu = \varepsilon^\mu(q) e^{-iqx} \rightarrow q^2 = 0 \text{ massless quanta}$$

4 components ε^μ ??

$$a) \partial_\mu A^\mu = 0 \rightarrow \varepsilon^\mu(q) q_\mu = 0 \rightarrow 3 \text{ components}$$

b) Gauge freedom:

$$A^\mu \rightarrow A^\mu + \partial^\mu \Lambda, \quad \square^2 \Lambda = 0$$

$$\Lambda = iae^{-iqx} \left(\leftarrow \square^2 \Lambda = q^2 \Lambda = 0 \text{ OK} \right)$$

$$\rightarrow \partial^\mu \Lambda = ia\partial^\mu e^{-iqx}$$

$$A^\mu \rightarrow A^\mu + \partial^\mu \Lambda = \varepsilon^\mu(q) e^{-iqx} + ia\partial^\mu e^{-iqx} = \left[\varepsilon^\mu(q) + ia(-iq_\mu) \right] e^{-iqx} = \left[\varepsilon^\mu(q) + aq_\mu \right] e^{-iqx}$$

$$\rightarrow \text{EM field unchanged by } \varepsilon^\mu(q) \rightarrow \varepsilon^\mu(q) + aq^\mu$$

Choose a to make $\varepsilon^0 = 0$

$$\rightarrow \varepsilon^\mu(q) q_\mu = 0 \rightarrow \boldsymbol{\varepsilon} \cdot \mathbf{q} = 0 \rightarrow 2 \text{ components}$$

W & Z - II

128

2 components \rightarrow 2 independent ε^μ

Take photon momentum along z

$$\varepsilon_1^\mu = (0 \ 1 \ 0 \ 0) \quad x\text{-linear polarization}$$

$$\varepsilon_2^\mu = (0 \ 0 \ 1 \ 0) \quad y\text{-linear polarization}$$

or

$$\varepsilon_L^\mu = \frac{1}{\sqrt{2}}(0 \ 1 \ -i \ 0) \quad \text{Left circular polarization: } S_z = -1$$

$$\varepsilon_R^\mu = \frac{1}{\sqrt{2}}(0 \ 1 \ +i \ 0) \quad \text{Right circular polarization: } S_z = +1$$

W & Z - III

129

Original wave equation:

$$\square^2 A^\mu - \partial^\mu (\partial_\nu A^\nu) = j^\mu$$

For a massive vector boson:

$$(\square^2 + m^2) B^\mu - \partial^\mu (\partial_\nu B^\nu) = j^\mu$$

Free particle:

$$(\square^2 + m^2) B^\mu - \partial^\mu (\partial_\nu B^\nu) = 0$$

But:

$$\partial_\mu (\square^2 + m^2) B^\mu - \partial_\mu \partial^\mu (\partial_\nu B^\nu) = 0 \rightarrow (\square^2 + m^2) \partial_\mu B^\mu - \square^2 (\partial_\nu B^\nu) = 0$$

$$\rightarrow m^2 \partial_\mu B^\mu = 0 \rightarrow \partial_\mu B^\mu = 0$$

Bottom line: Not an extra condition...

$$\rightarrow (\square^2 + m^2) B^\mu = 0$$

$$B^\mu = \varepsilon^\mu(p) e^{-ipx} \rightarrow \varepsilon^\mu p_\mu = 0 \rightarrow 3 \text{ independent components}$$

No gauge freedom...

W & Z - IV

130

3 independent components \rightarrow 3 independent ε^μ

Take photon momentum along z

$$\varepsilon_L^\mu = \frac{1}{\sqrt{2}}(0 \ 1 \ -i \ 0) \text{ Left circular polarization: } S_z = -1$$

$$\varepsilon_R^\mu = -\frac{1}{\sqrt{2}}(0 \ 1 \ +i \ 0) \text{ Right circular polarization: } S_z = +1$$

To find 3rd polarization 4-vector:

$$\varepsilon_0^\mu = \frac{1}{\sqrt{\alpha^2 - \beta^2}}(\alpha \ 0 \ 0 \ \beta) \rightarrow \varepsilon^\mu p_\mu = 0 \rightarrow \alpha E - \beta p_z = 0, \quad \frac{1}{\sqrt{\alpha^2 - \beta^2}} \text{ normalization}$$

$$\rightarrow \varepsilon_0^\mu = \frac{1}{m}(p_z \ 0 \ 0 \ E) \text{ Longitudinal polarization: } S_z = 0$$

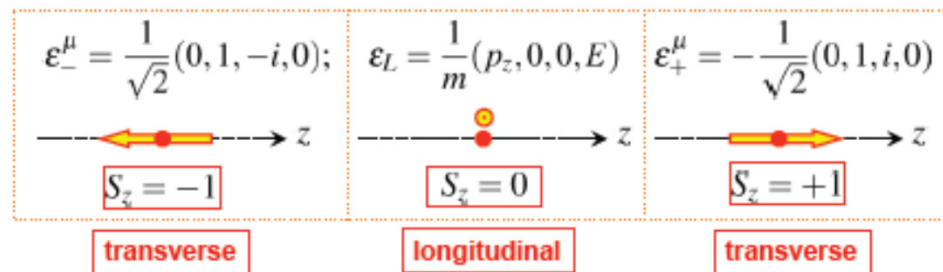

W & Z - V

131

Decay: $W^- \rightarrow e^- + \bar{\nu}_e$

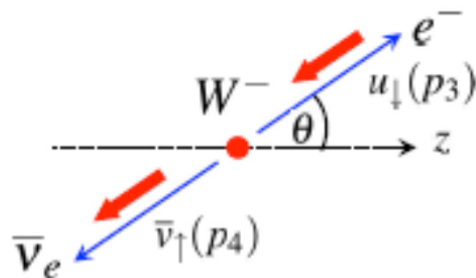
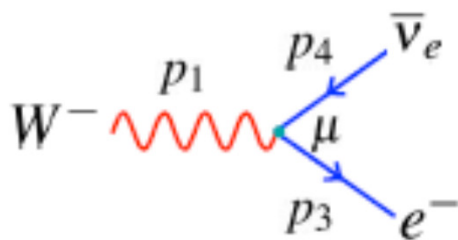

Matrix element:

$$M_{fi} = \frac{g}{\sqrt{2}} \varepsilon_\mu(p_1) \bar{u}(p_3) \frac{1}{2} \gamma^\mu (1 - \gamma_5) v(p_4) = \frac{g}{\sqrt{2}} \varepsilon_\mu(p_1) j^\mu$$

$\bar{u}(p_3)$: outgoing fermion, $v(p_4)$: outgoing antifermion

$$\begin{aligned} \bar{u}(p_3) \gamma^\mu \frac{1}{2} (1 - \gamma_5) v(p_4) &= \bar{u}(p_3) \frac{1}{2} \gamma^\mu (1 - \gamma_5) \frac{1}{2} \gamma^\mu (1 - \gamma_5) v(p_4) \\ &= \underbrace{\bar{u}(p_3) \frac{1}{2} (1 + \gamma_5)}_{\bar{e}_L} \gamma^\mu \underbrace{\frac{1}{2} (1 - \gamma_5) v(p_4)}_{\nu_R} = \bar{e}_L \gamma^\mu \nu_R \end{aligned}$$

LR current :

Build from rotated L, R spinors

$$j^\mu = \bar{u}_\downarrow(p_3) \frac{1}{2} \gamma^\mu v_\uparrow(p_4) = 2E(0, -\cos\theta, -i, \sin\theta)$$

W & Z - VI

132

W polarization states in the rest system:

$$\varepsilon_L^\mu = \frac{1}{\sqrt{2}}(0 \ 1 \ -i \ 0)$$

$$\varepsilon_R^\mu = -\frac{1}{\sqrt{2}}(0 \ 1 \ +i \ 0)$$

$$\varepsilon_0^\mu = \frac{1}{m}(0 \ 0 \ 0 \ m) = (0 \ 0 \ 0 \ 1)$$

Matrix elements for different W polarization states in the rest system:

$$\varepsilon_L^\mu : \frac{g}{\sqrt{2}} \frac{1}{\sqrt{2}}(0 \ 1 \ -i \ 0) 2 \frac{M_W}{2}(0, -\cos\theta, -i, \sin\theta) = -\frac{gM_W}{2}(1 + \cos\theta) \rightarrow |M_L|^2 = \frac{g^2 M_W^2}{4}(1 + \cos\theta)^2$$

$$\varepsilon_R^\mu : \frac{g}{\sqrt{2}} \left[-\frac{1}{\sqrt{2}}(0 \ 1 \ +i \ 0) \right] 2 \frac{M_W}{2}(0, -\cos\theta, -i, \sin\theta) = -\frac{gM_W}{2}(1 - \cos\theta) \rightarrow |M_R|^2 = \frac{g^2 M_W^2}{4}(1 - \cos\theta)^2$$

$$\varepsilon_0^\mu : \frac{g}{\sqrt{2}} \frac{1}{m}(0 \ 0 \ 0 \ m) 2 \frac{M_W}{2}(0, -\cos\theta, -i, \sin\theta) = \frac{gM_W}{\sqrt{2}} \sin\theta \rightarrow |M_0|^2 = \frac{g^2 M_W^2}{2} \sin^2\theta$$

W & Z - VII

133

$$|M_L|^2 = \frac{g^2 M_W^2}{4} (1 + \cos \theta)^2$$

$$|M_R|^2 = \frac{g^2 M_W^2}{4} (1 - \cos \theta)^2$$

$$|M_0|^2 = \frac{g^2 M_W^2}{2} \sin^2 \theta$$

2-body differential decay rate:

$$\frac{d\Gamma_{L,O,R}}{d\Omega} = \frac{p}{32\pi^2 M_W^2} |M|^2 = \frac{1}{64\pi^2 M_W} |M|^2 = \frac{g^2 M_W}{64\pi^2} \begin{cases} \frac{1}{4} (1 + \cos \theta)^2 \\ \frac{1}{2} \sin^2 \theta \\ \frac{1}{4} (1 - \cos \theta)^2 \end{cases}$$

Total rates:

$$\int \frac{1}{4} (1 \pm \cos \theta)^2 d \cos \theta d\varphi = \int \frac{1}{2} \sin^2 \theta d \cos \theta d\varphi = \frac{4\pi}{3}$$

$$\rightarrow \Gamma_L = \Gamma_R = \Gamma_0 = \frac{g^2 M_W}{48\pi}$$

W & Z - VIII

134

$$|M_L|^2 = \frac{g^2 M_W^2}{4} (1 + \cos \theta)^2$$

$$|M_R|^2 = \frac{g^2 M_W^2}{4} (1 - \cos \theta)^2$$

$$|M_0|^2 = \frac{g^2 M_W^2}{2} \sin^2 \theta$$

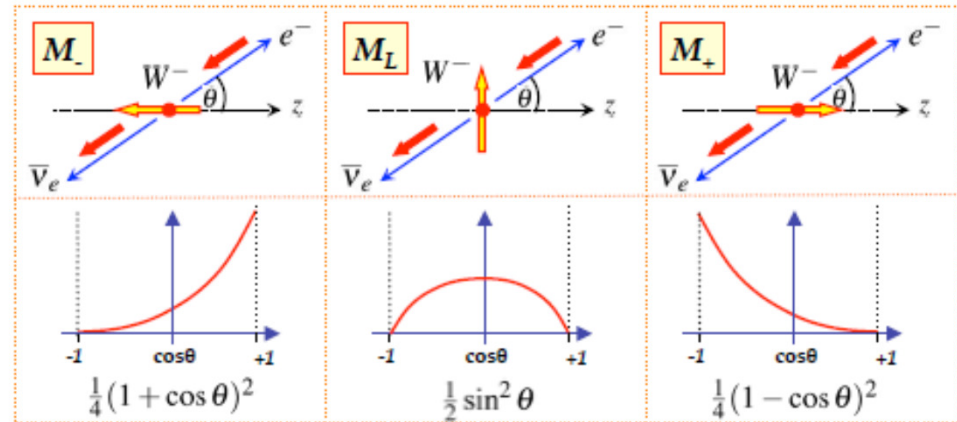

Averaging over the initial spin states:

$$\langle |M|^2 \rangle = \frac{1}{3} g^2 M_W^2 \left[\frac{1}{4} (1 + \cos \theta)^2 + \frac{1}{4} (1 - \cos \theta)^2 + \frac{1}{2} \sin^2 \theta \right]$$

$$\rightarrow \langle |M|^2 \rangle = \frac{1}{3} g^2 M_W^2$$

Isotropic: OK for an unpolarized mother particle

$$\rightarrow \Gamma(W^- \rightarrow e^- + \bar{\nu}_e) = \frac{g^2 M_W}{48\pi}$$

W & Z - IX

135

Considering all the others decay modes: Large W mass \rightarrow All fermions \approx massless

Do *not* count Top: Too heavy, decay energetically forbidden

Color factor = 3

Similar to $e^+e^- \rightarrow q\bar{q}$: Take quarks as free, on shell particles

Taking into account CKM mixing:

$$W^- \rightarrow e^- \bar{\nu}_e \quad W^- \rightarrow d\bar{u} \times 3|V_{ud}|^2 \quad W^- \rightarrow d\bar{c} \times 3|V_{cd}|^2$$

$$W^- \rightarrow \mu^- \bar{\nu}_\mu \quad W^- \rightarrow s\bar{u} \times 3|V_{us}|^2 \quad W^- \rightarrow s\bar{c} \times 3|V_{cs}|^2$$

$$W^- \rightarrow \tau^- \bar{\nu}_\tau \quad W^- \rightarrow b\bar{u} \times 3|V_{ub}|^2 \quad W^- \rightarrow b\bar{c} \times 3|V_{cb}|^2$$

CKM Unitarity:

$$e.g. \quad |V_{ud}|^2 + |V_{us}|^2 + |V_{ub}|^2 = 1 \quad \text{etc}$$

$$\rightarrow \Gamma_W = 9\Gamma_{W \rightarrow e\nu} = \frac{3g^2 M_W}{16\pi} = 2.07 \text{ GeV}$$

Experiment:

$$2.14 \pm 0.04 \text{ GeV}$$

QCD corrections..

W & Z - X

136

Z couplings:

$$c_L = I_3 - Q \sin^2 \theta_W$$

$$c_R = -Q \sin^2 \theta_W$$

$$j_\mu^Z = g_Z \bar{u} \gamma_\mu \left[c_L \frac{1}{2} (1 - \gamma_5) + c_R \frac{1}{2} (1 + \gamma_5) \right] u$$

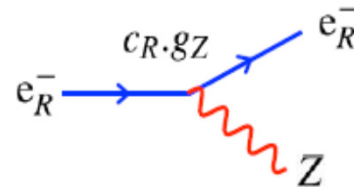
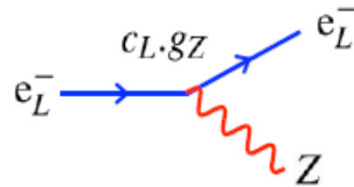

$$c_V = c_L + c_R = I_3 - 2Q \sin^2 \theta_W$$

$$c_A = c_L - c_R = I_3$$

W & Z - XI

137

Therefore:

$$\sin^2 \theta_W \approx 0.23$$



Fermion	Q	I_W^3	c_L	c_R	c_V	c_A
ν_e, ν_μ, ν_τ	0	$+\frac{1}{2}$	$+\frac{1}{2}$	0	$+\frac{1}{2}$	$+\frac{1}{2}$
e^-, μ^-, τ^-	-1	$-\frac{1}{2}$	-0.27	0.23	-0.04	$-\frac{1}{2}$
u, c, t	$+\frac{2}{3}$	$+\frac{1}{2}$	0.35	-0.15	+0.19	$+\frac{1}{2}$
d, s, b	$-\frac{1}{3}$	$-\frac{1}{2}$	-0.42	0.08	-0.35	$-\frac{1}{2}$

W & Z - XII

138

Z couplings: Both to L and R fermions

Nevertheless:

Only 2 vertexes, remaining 2 = 0

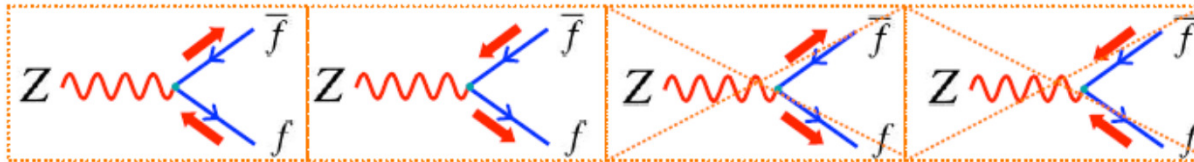

To show that RR vertex is 0 (LL similar):

$$\begin{aligned} \bar{u}_R &= u_R^\dagger \gamma^0 = u^\dagger \frac{1+\gamma^5}{2} \gamma^0, & v_R &= \frac{1-\gamma^5}{2} v \\ \bar{u}_R \gamma^\mu (c_V + c_A \gamma_5) v_R &= u^\dagger \frac{1+\gamma^5}{2} \gamma^0 \gamma^\mu (c_V + c_A \gamma_5) \frac{1-\gamma^5}{2} v \\ &= \frac{1}{4} u^\dagger \gamma^0 (1-\gamma^5)(1-\gamma^5) (c_V + c_A \gamma_5) v \\ &= \bar{u} \gamma^\mu \underbrace{\frac{1+\gamma^5}{2} \frac{1-\gamma^5}{2}}_{=0} (c_V + c_A \gamma_5) v = 0 \end{aligned}$$

W & Z - XIII

139

Decay: $Z^0 \rightarrow e^+ + e^-$

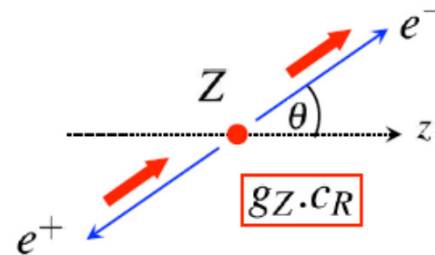
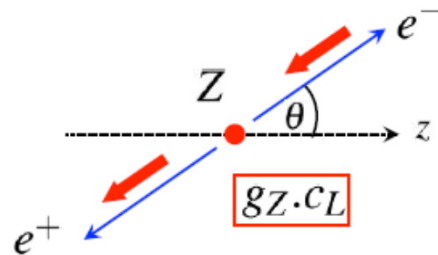

$$\langle |M|^2 \rangle = \frac{2}{3} g^2 \cos^2 \theta_W M_Z^2 [c_L^2 + c_R^2]$$

$$2[c_L^2 + c_R^2] = [c_V^2 + c_A^2]$$

$$\rightarrow \Gamma(Z \rightarrow e^+ e^-) = \frac{g^2 \cos^2 \theta_W M_Z}{48\pi} [c_V^2 + c_A^2]$$

W & Z - XIV

140

$$Br(Z \rightarrow e^+e^-) = Br(Z \rightarrow \mu^+\mu^-) = Br(Z \rightarrow \tau^+\tau^-) \approx 3.5\%$$

$$Br(Z \rightarrow \nu_1\bar{\nu}_1) = Br(Z \rightarrow \nu_2\bar{\nu}_2) = Br(Z \rightarrow \nu_3\bar{\nu}_3) \approx 6.9\%$$

$$Br(Z \rightarrow d\bar{d}) = Br(Z \rightarrow s\bar{s}) = Br(Z \rightarrow b\bar{b}) \approx 15\%$$

$$Br(Z \rightarrow u\bar{u}) = Br(Z \rightarrow c\bar{c}) \approx 12\%$$

$$Br(Z \rightarrow \text{hadrons}) \approx 69\%$$

$$\rightarrow \Gamma_Z = \sum_i \Gamma_i = 2.5 \text{ GeV}$$

$$\text{Experiment: } \Gamma_Z = 2.4952 \pm 0.0023 \text{ GeV}$$



W & Z - XV

141

Ultimate systematics....

Moon:

- ♦ As the moon orbits the Earth it distorts the rock in the Geneva area very slightly !
- ♦ The nominal radius of the accelerator of 4.3 km varies by ± 0.15 mm
- ♦ Changes beam energy by ~ 10 MeV : need to correct for tidal effects !

Trains:

- ♦ Leakage currents from the TGV railway line return to Earth following the path of least resistance.
- ♦ Travelling via the Versoix river and using the LEP ring as a conductor.
- ♦ Each time a TGV train passed by, a small current circulated LEP slightly changing the magnetic field in the accelerator
- ♦ LEP beam energy changes by ~ 10 MeV

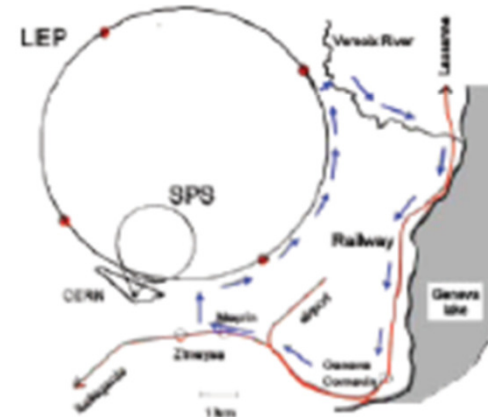

W & Z Discovery - I

142

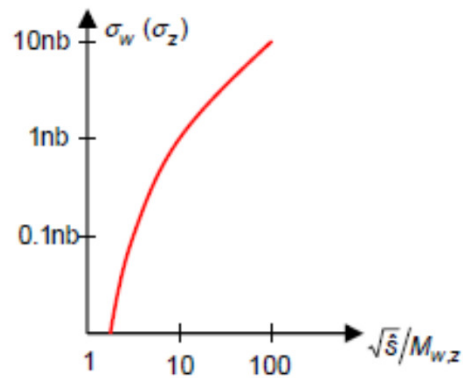
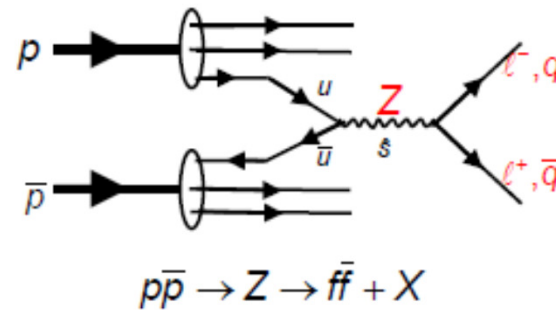
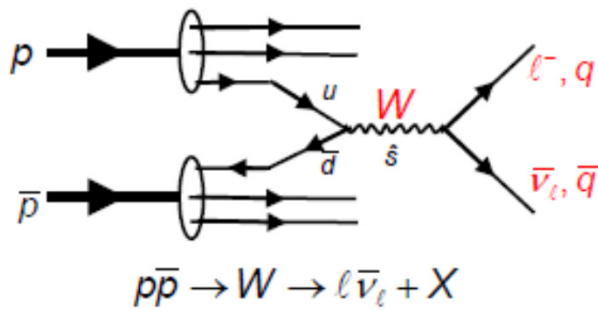

Similar to Drell-Yan: (photon instead of W)

$$\hat{s} = x_q x_{\bar{q}} s \quad \langle x_q \rangle \approx 0.12$$

$$\hat{s} = \langle x_q \rangle^2 s \approx 0.014 s = (65 \text{ GeV})^2$$

→ Cross section is small !

W & Z Discovery - II

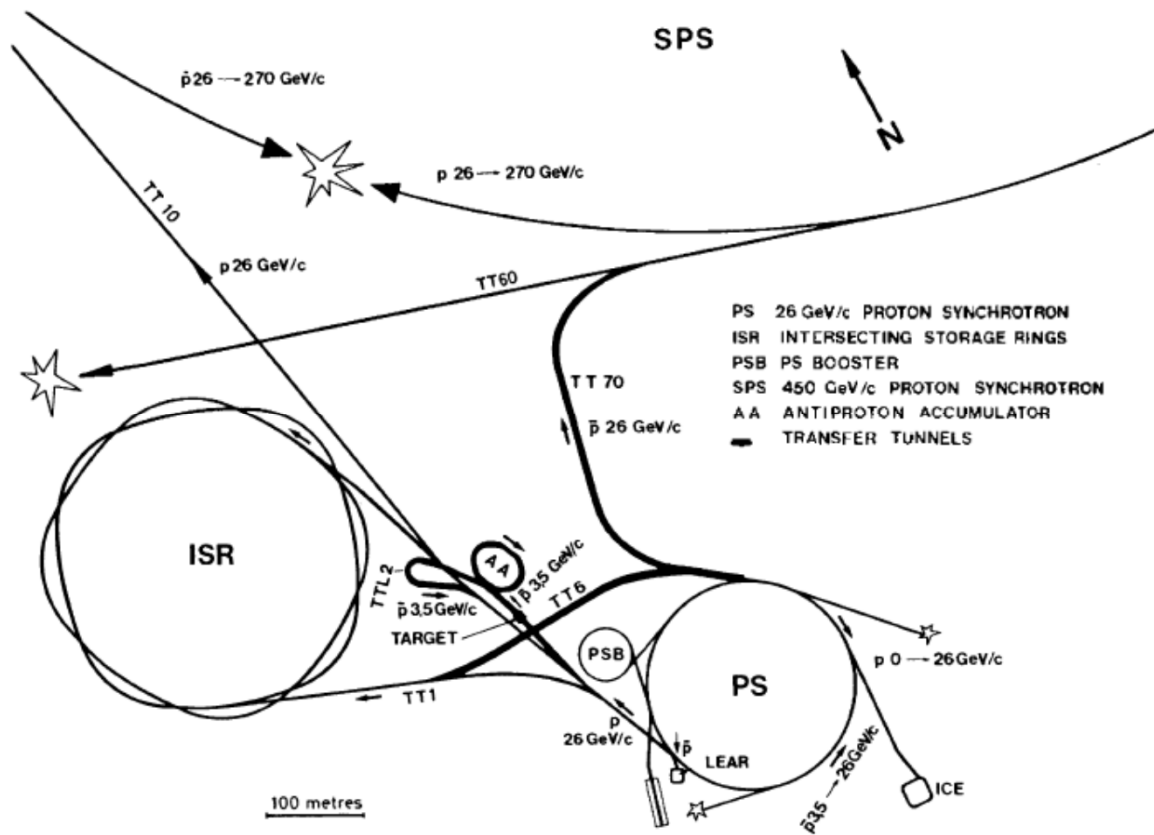

W & Z Discovery - III

144

S $\bar{p}p$ S Collider main parameters

- $\sqrt{s} = 540 \text{ GeV}$
- 3 bunches protons, 3 bunches antiprotons,
10¹¹ particles per bunch
- Luminosity = $5 \times 10^{27} \text{ cm}^{-2}\text{sec}^{-1}$
- First collisions in December 1981

W & Z Discovery - IV

145

Stochastical cooling system

Basic principle

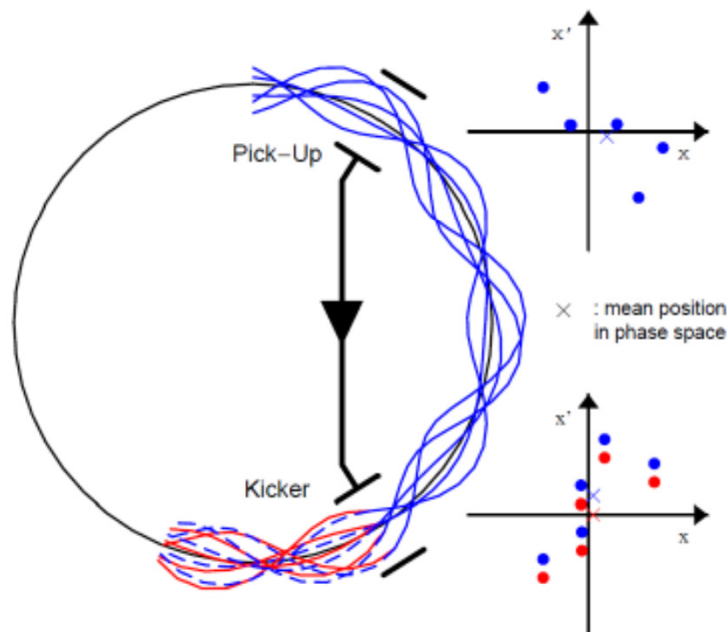

- 10^7 antiprotons with $p = 3.5 \text{ GeV}/c$ gets in outer part of toroidal vacuum chamber
- Inductor measures discrepancy of particles
- Correction signal is send to opposite side
- Magnet deflects particles

W & Z Discovery - V

146

UA1 Detector
Central Tracker
EM calorimeter
Hadron Calorimeter
Muon System

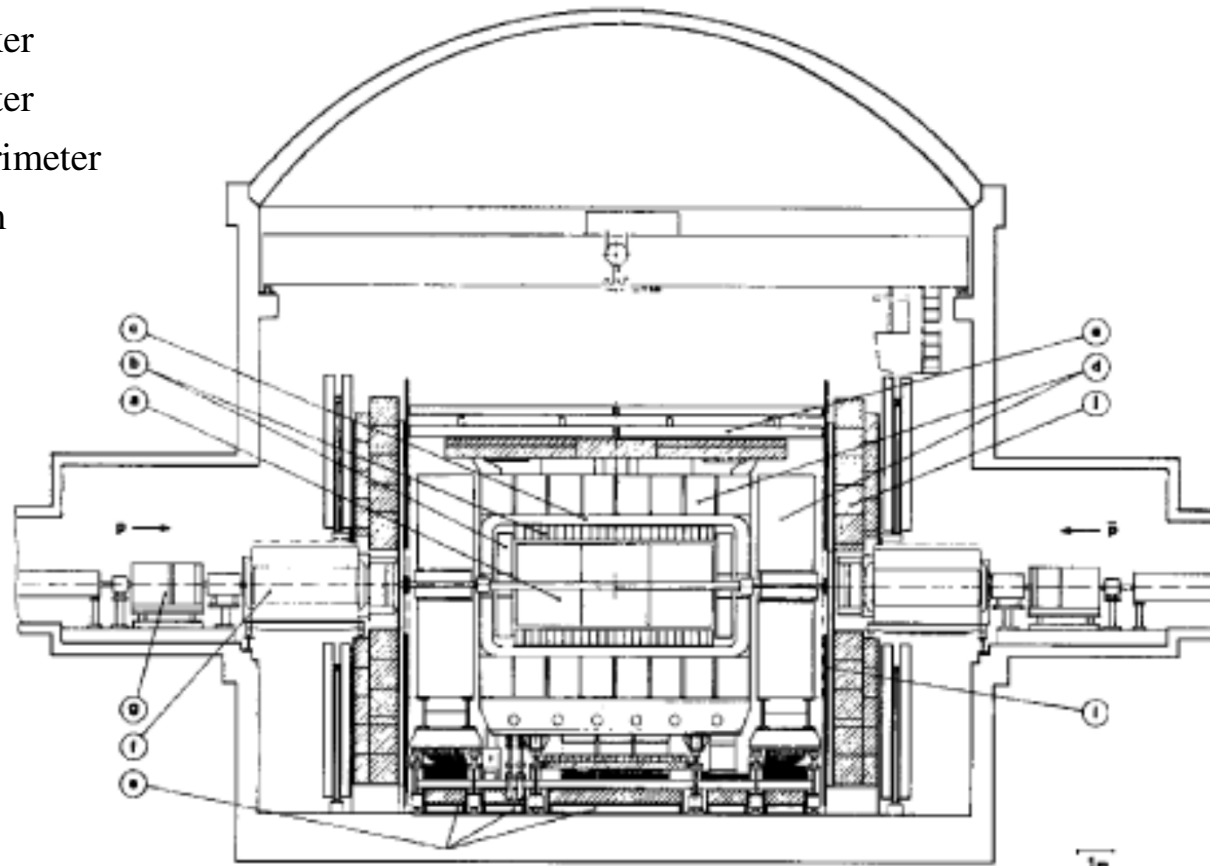

W & Z Discovery - VI

147

Several conditions to select events

- More than 10000 events/s, most of them selected by a trigger
- Trace in central detector must point into center of electromagnetic shower
- Transversal momentum in central detector > 7 GeV
- Trace must be isolated (only other traces with transversal momentum < 2.5 GeV allowed)
- Missing energy > 15 GeV, has to point contrary to trace of electron

W & Z Discovery - VII

148

UA1 $W \rightarrow e\nu$ candidate event

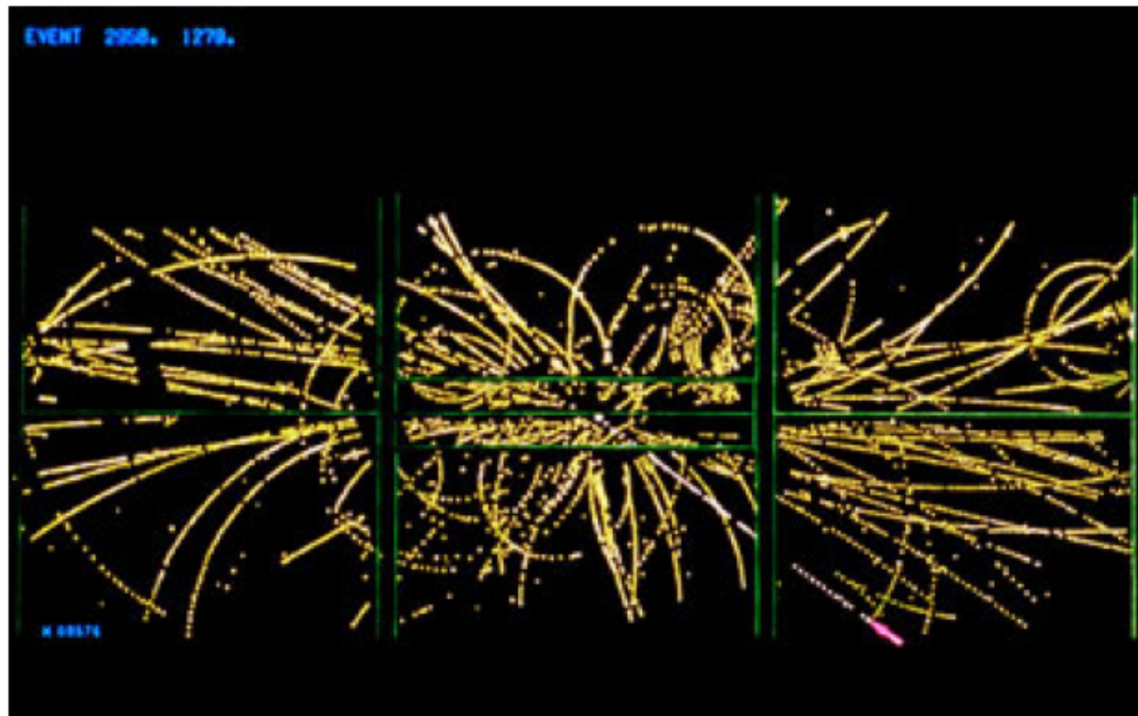

W & Z Discovery - VIII

149

Hadrons
Electron

$$\vec{p}_\perp(\nu) = -\vec{p}_\perp(H) - \vec{p}_\perp(e).$$

Neutrino (invisible)

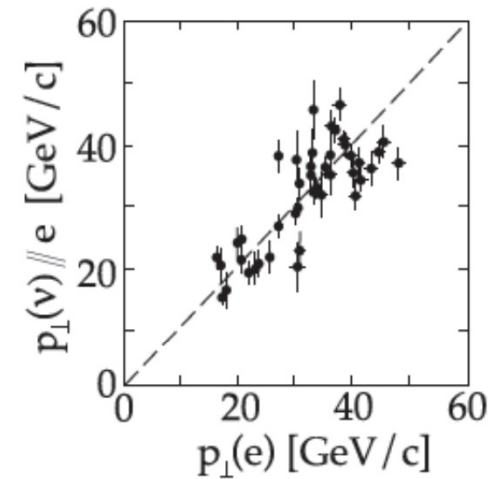
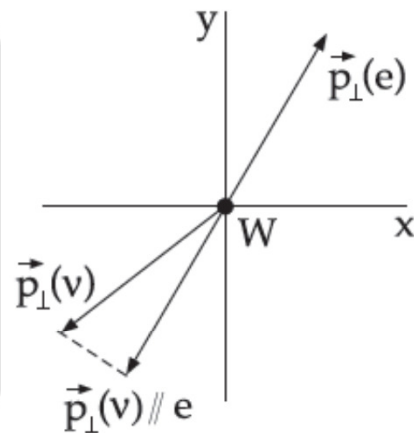

- Calculate sum of all hadron momenta in the **transverse plane** (to avoid leaks along the beam lines)
- $\mathbf{p}_T(\nu)$ not exactly antiparallel to $\mathbf{p}_T(e)$
 - ◆ W boson not always produced at rest, finite detector resolution

W & Z Discovery - IX

150

UA2 Candidate Z event

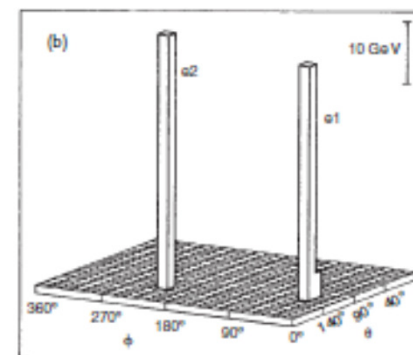
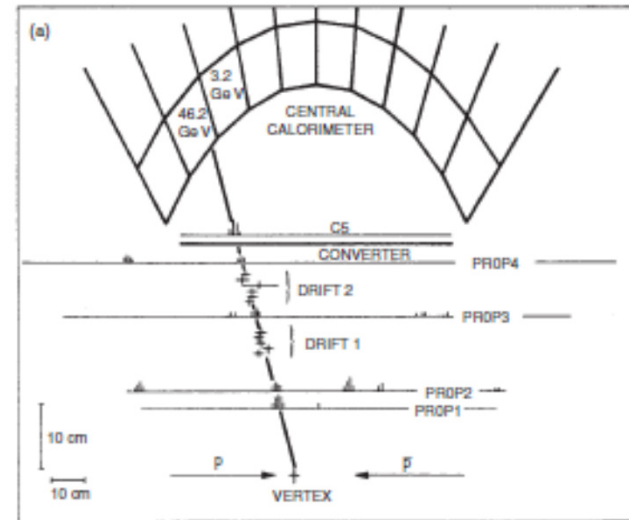

W & Z Discovery - X

151

$$\frac{d\sigma}{d\cos\theta^*} = \text{const} \quad \text{Just an approximation}$$

$$\frac{d\sigma}{dp_T} = \frac{d\sigma}{d\cos\theta^*} \frac{d\cos\theta^*}{dp_T}$$

$$p_T = p^* \sin\theta^* = \frac{M_W}{2} \sin\theta^*$$

$$\rightarrow \sin\theta^* = \frac{2p_T}{M_W}$$

$$\rightarrow \cos\theta^* = \sqrt{1 - \sin^2\theta^*} = \sqrt{1 - \left(\frac{2p_T}{M_W}\right)^2}$$

$$\rightarrow \frac{d\cos\theta^*}{dp_T} = \frac{\frac{4p_T}{M_W}}{2\sqrt{1 - \left(\frac{2p_T}{M_W}\right)^2}} = \frac{2p_T}{M_W \sqrt{1 - \left(\frac{2p_T}{M_W}\right)^2}}$$

$$\rightarrow \frac{d\sigma}{dp_T} = A(\cos\theta^*) \frac{d\cos\theta^*}{dp_T} \approx K \frac{2p_T}{M_W \sqrt{1 - \left(\frac{2p_T}{M_W}\right)^2}} \quad \text{Jacobian peak at } \frac{M_W}{2}$$

W & Z Discovery - XI

152

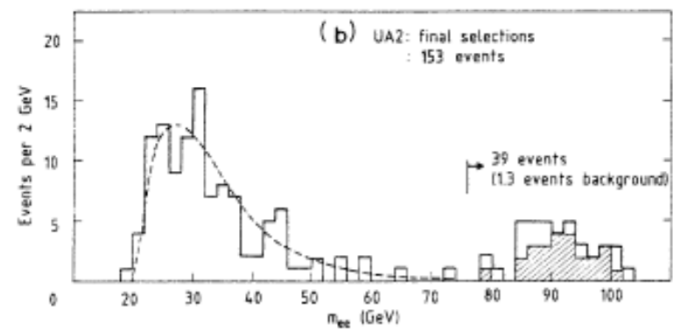
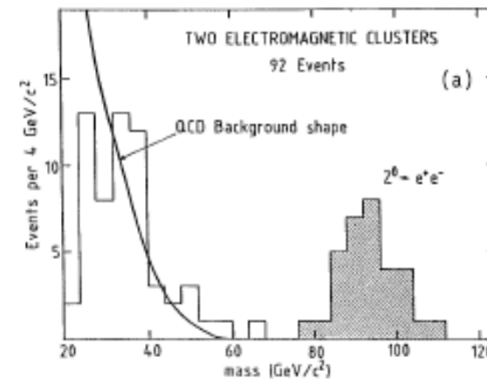
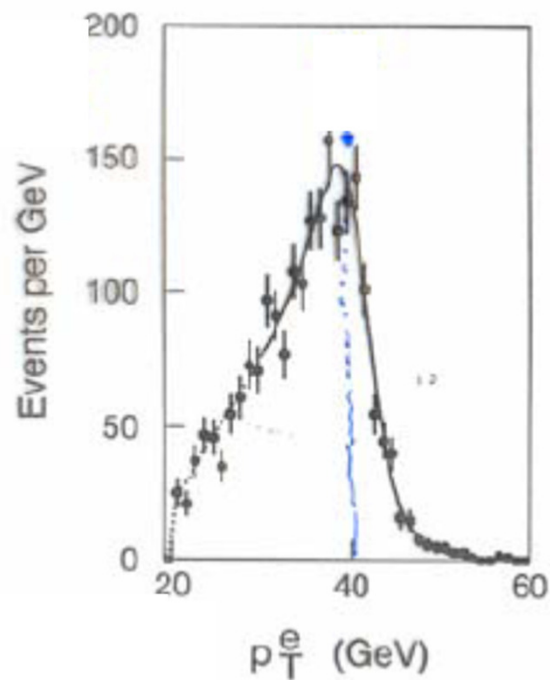

W & Z Discovery - XII

153

D0 $Z \rightarrow e^+e^-$

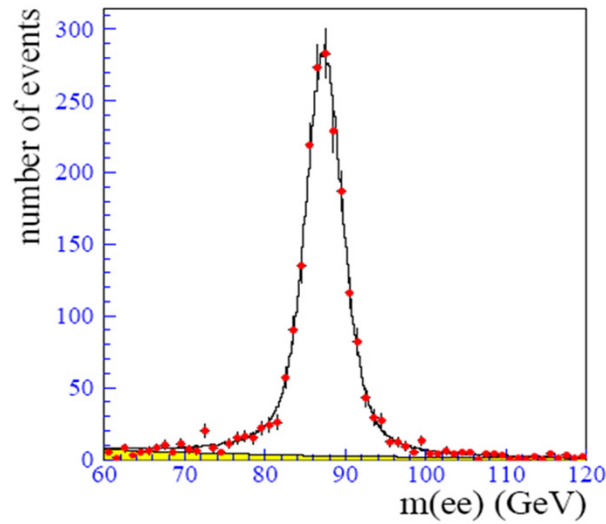

CDF $W \rightarrow \mu\nu$

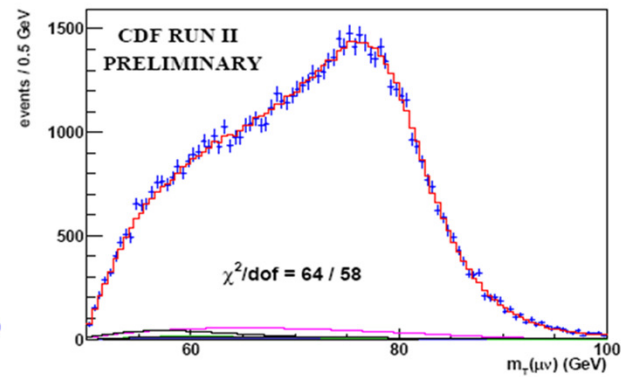

$$m_{W^\pm} = 82.1 \pm 1.7 \text{ GeV}$$

$$m_{Z^0} = 93.0 \pm 1.7 \text{ GeV}$$

Current values (Particle Data Group 2006):

$$m_{W^\pm} = 80.403 \pm 0.029 \text{ GeV}$$

$$m_{Z^0} = 91.1876 \pm 0.0021 \text{ GeV}$$

SM Internal Consistency - I

155

Reconsidering hypothetical, troublesome reaction

$$\nu\bar{\nu} \rightarrow W_L^+ W_L^-$$

at very high energy

Polarization 4-vectors of longitudinally polarized Ws:

$$\varepsilon_L^\mu(p) = \frac{p^\mu}{m_W} + O\left(\frac{m_W}{p^0}\right) \sim \frac{p^\mu}{m_W}$$

Divergent term of matrix element:

$$M_{fi} \approx -\frac{g^2}{8} \bar{\nu}(l)(1-\gamma_5) \frac{1}{\not{q}-m} (1-\gamma_5) u(k) \frac{r^\mu}{m_W} \frac{p^\nu}{m_W}$$

$$M_{fi} \approx -\frac{g^2}{4m_W^2} \bar{\nu}(l) \not{p}' (1-\gamma_5) u(k) - \frac{g^2}{8m_W^2} m \bar{\nu}(l) (1+\gamma_5) \frac{\not{q}+m}{q^2-m^2} \not{p}' (1-\gamma_5) u(k)$$

$$M_{fi}^a \approx -\frac{g^2}{4m_W^2} \bar{\nu}(l) \not{p}' (1-\gamma_5) u(k)$$

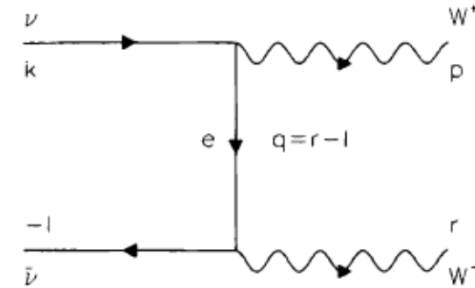

SM Internal Consistency - II

156

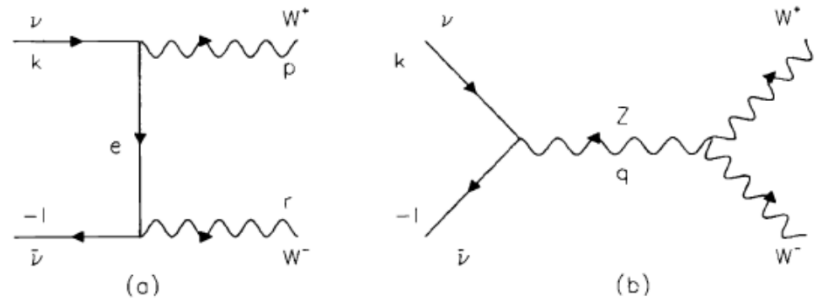

Standard Model: Neutral Current \rightarrow Two diagrams instead of one

$M_{fi}^b : Z^0$ matrix element:

$\nu\nu Z, WWZ$ vertexes, Z propagator

After quite intense calculations....

$$M_{fi}^b \approx \frac{g^2}{4m_W^2} \bar{v}(l) \not{\epsilon} (1 - \gamma_5) u(k)$$

$$\rightarrow M_{fi}^b + M_{fi}^b = 0$$

Divergence fixed in a gauge theory!

SM Internal Consistency - III

157

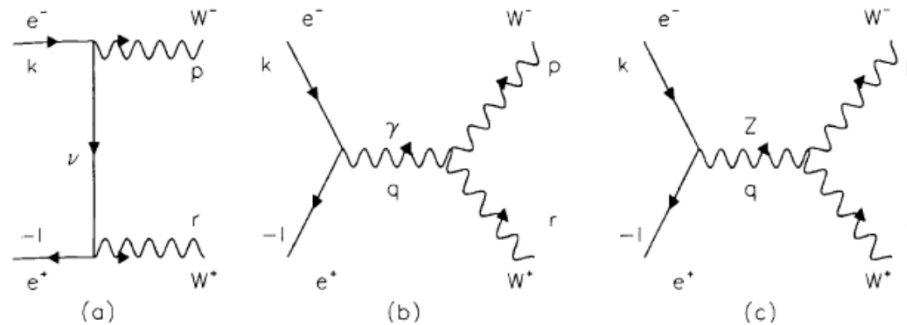

Another, similar reaction

$$e^+e^- \rightarrow W_L^+W_L^-$$

Quite realistic!

$$M_{fi}^a \approx -\frac{g^2}{4m_W^2} \bar{v}(l) \not{p} (1 - \gamma_5) u(k)$$

$$M_{fi}^b \approx \frac{e^2}{m_W^2} \bar{v}(l) \not{p} u(k)$$

$$M_{fi}^c \approx -\frac{g_{WWZ}}{2m_W^2} \bar{v}(l) [g_L \not{p} (1 - \gamma_5) + g_R \not{p} (1 + \gamma_5)] u(k)$$

$$\rightarrow M_{fi}^a + M_{fi}^b + M_{fi}^c \approx -\frac{g^2}{4m_W^2} m \bar{v}(l) u(k) \text{ Still (weakly) divergent at high energy}$$

SM Internal Consistency - IV

158

Reason of extra divergence: R chiral parts of massive fermions

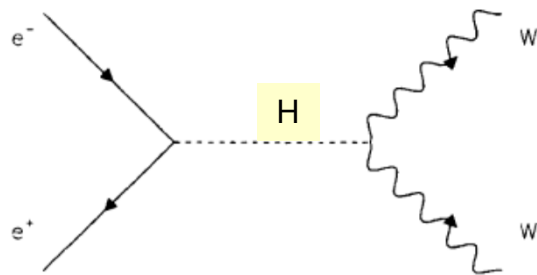

Higgs diagram:

$$M_{fi}^H \approx -\frac{1}{2m_W^2} g_{eeH} g_{WWH} \bar{v}(l) u(k)$$

→ Correct compensation with gauge theory & SSB

Strong support for the Standard Model:

Higgs *must* be there

(or something really new must happen at ~ 1 TeV to save unitarity)

SM Internal Consistency - V

159

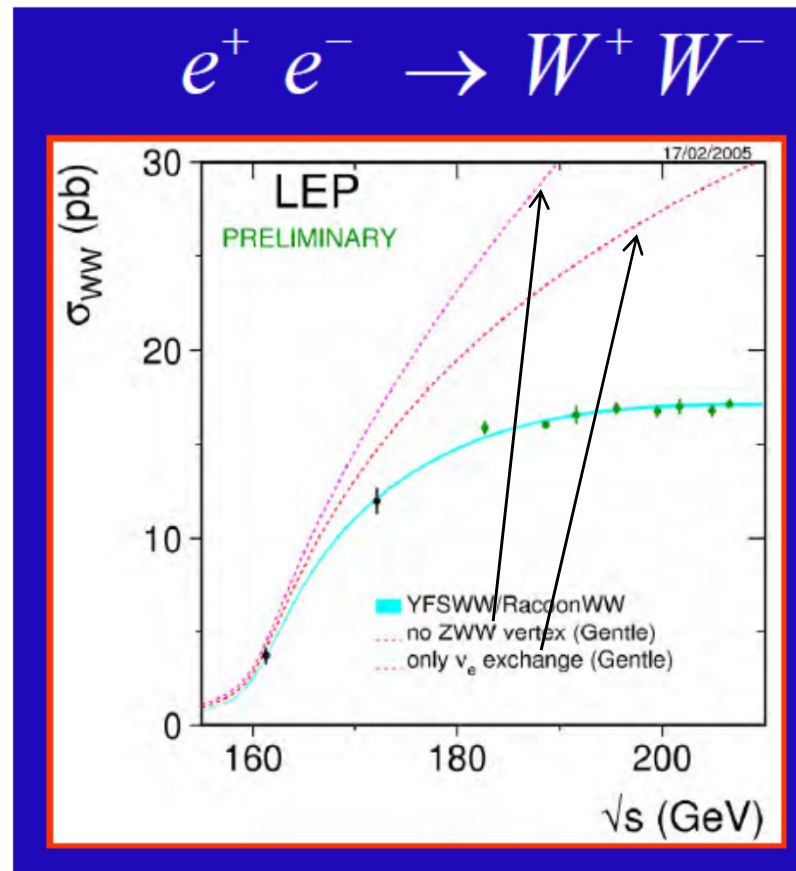

Precision Tests - I

160

LEP – Precision tests of SM 1989-2000



26 km circumference

4 large experiments: ALEPH, DELPHI, L3, OPAL

1989 – 1995

$$\sqrt{s} = 91.2 \text{ GeV}$$

$17 \cdot 10^6$ Z^0 detected

1996 – 2000

$$\sqrt{s} = 161 - 208 \text{ GeV}$$

$30 \cdot 10^3$ WW detected

Precision Tests - II

161

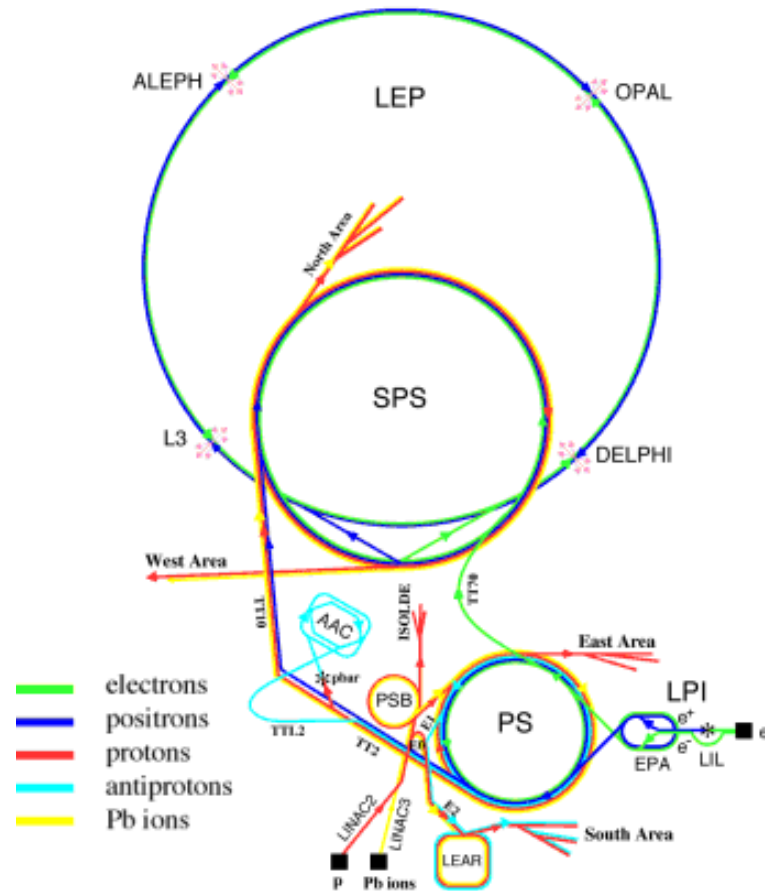

Precision Tests - III

162

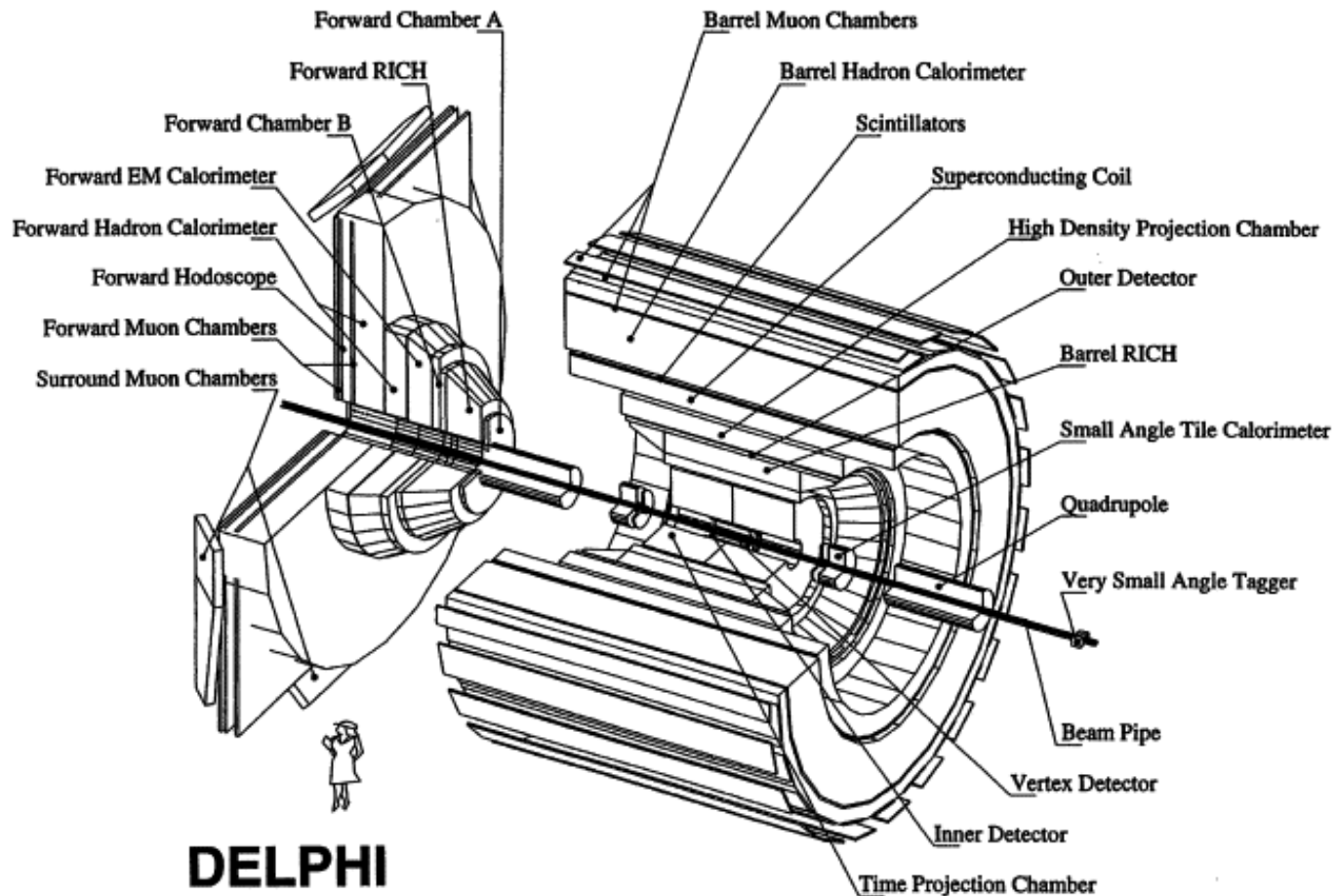

Precision Tests - IV

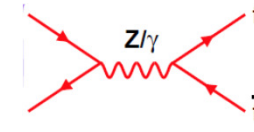
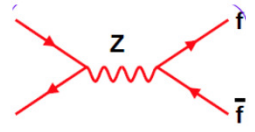
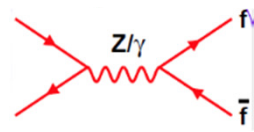
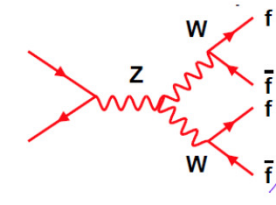
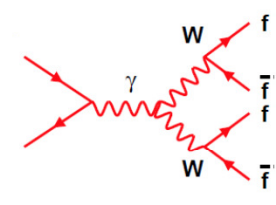
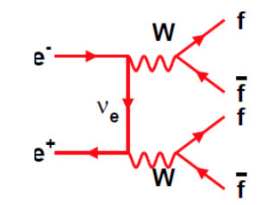
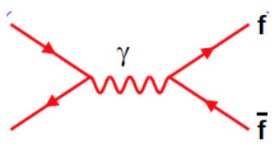
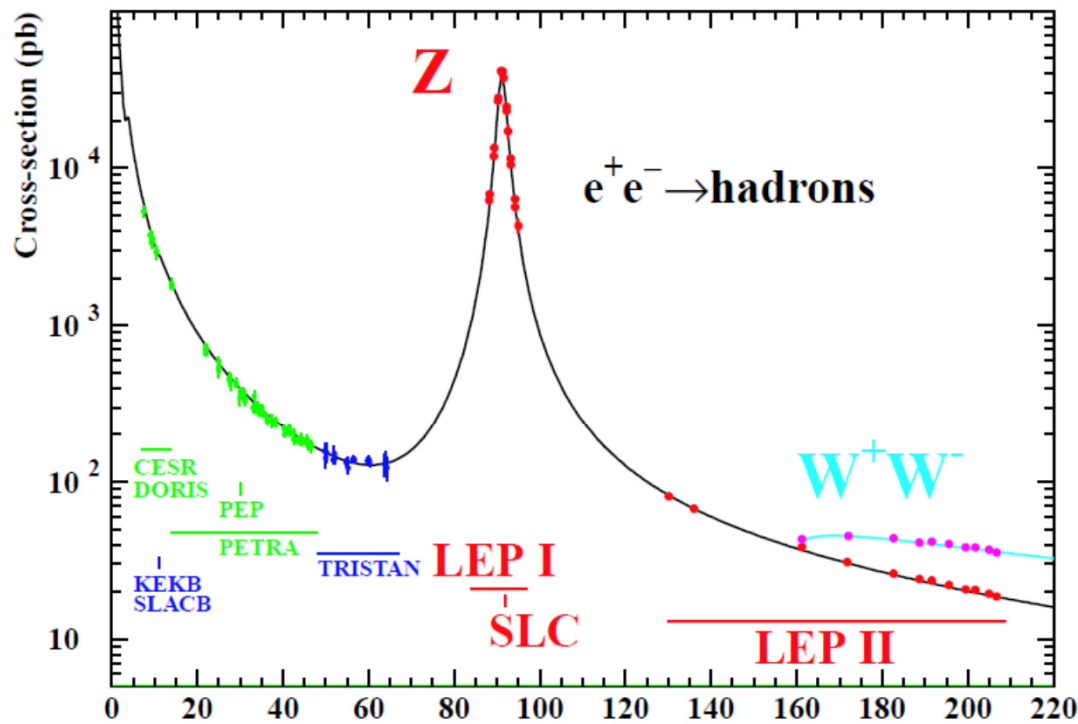

Precision Tests - V

164

$e^+e^- \rightarrow \mu^+\mu^-$ at the Z peak

Only consider (dominant) Z diagram

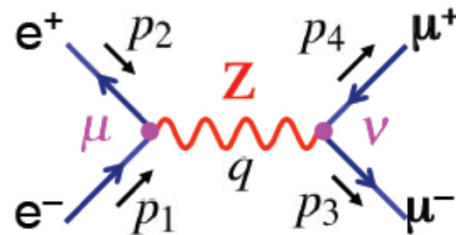

Electron vertex:

$$\bar{v}(p_2)(-ig_Z\gamma^\mu)\frac{1}{2}(c_V - c_A\gamma^5)u(p_1) \quad \text{Electron } c_V, c_A$$

Z propagator:

$$-i\frac{g_{\mu\nu}}{q^2 - m_Z^2} \quad \text{Approximate, see later}$$

Muon vertex:

$$\bar{u}(p_3)(-ig_Z\gamma^\nu)\frac{1}{2}(c_V - c_A\gamma^5)v(p_4) \quad \text{Muon } c_V, c_A$$

Precision Tests- VI

165

Ultrarelativistic limit \rightarrow Chirality \simeq Helicity

\rightarrow Use helicity eigenstates for electron, muon vertexes

$$c_L = c_V + c_A, c_R = c_V - c_A$$

$$\rightarrow c_V = \frac{1}{2}(c_L + c_R), c_A = \frac{1}{2}(c_L - c_R)$$

$$\frac{1}{2}(c_V - c_A \gamma^5) \rightarrow \frac{1}{2}c_L(1 - \gamma^5) + \frac{1}{2}c_R(1 + \gamma^5)$$

\rightarrow Matrix element:

$$\left[c_L \bar{v}(p_2) \gamma^\mu \frac{1}{2}(1 - \gamma^5) u(p_1) + c_R \bar{v}(p_2) \gamma^\mu \frac{1}{2}(1 + \gamma^5) u(p_1) \right]$$
$$\times \left(-\frac{g_Z}{q^2 - m_Z^2} g_{\mu\nu} \right)$$
$$\times \left[c_L \bar{u}(p_3) \gamma^\nu \frac{1}{2}(1 - \gamma^5) v(p_4) + c_R \bar{u}(p_3) \gamma^\nu \frac{1}{2}(1 + \gamma^5) v(p_4) \right]$$

Introduce chirality \simeq helicity projectors:

$$\frac{1}{2}(1 - \gamma^5)u \simeq u_\downarrow, \frac{1}{2}(1 + \gamma^5)u \simeq u_\uparrow, \frac{1}{2}(1 - \gamma^5)v \simeq v_\uparrow, \frac{1}{2}(1 + \gamma^5)v \simeq v_\downarrow$$

Precision Tests- VII

166

→ Matrix element:

$$\left[c_L \bar{\nu}(p_2) \gamma^\mu u_\downarrow(p_1) + c_R \bar{\nu}(p_2) \gamma^\mu u_\uparrow(p_1) \right] \left(-\frac{g_Z}{q^2 - m_Z^2} g_{\mu\nu} \right) \left[c_L \bar{u}(p_3) \gamma^\nu v_\uparrow(p_4) + c_R \bar{u}(p_3) \gamma^\nu v_\downarrow(p_4) \right]$$

$$\bar{\nu}(p_2) = \bar{\nu}_\uparrow(p_2) + \bar{\nu}_\downarrow(p_2), \bar{u}(p_3) = \bar{u}_\uparrow(p_3) + \bar{u}_\downarrow(p_3)$$

Surviving terms in both e, μ currents: LR, RL only

$$\rightarrow \left[c_L \bar{\nu}_\uparrow(p_2) \gamma^\mu u_\downarrow(p_1) + c_R \bar{\nu}_\downarrow(p_2) \gamma^\mu u_\uparrow(p_1) \right] \left(-\frac{g_Z}{q^2 - m_Z^2} g_{\mu\nu} \right) \left[c_L \bar{u}_\downarrow(p_3) \gamma^\nu v_\uparrow(p_4) + c_R \bar{u}_\uparrow(p_3) \gamma^\nu v_\downarrow(p_4) \right]$$

$M_{RR} = -\frac{g_Z^2}{q^2 - m_Z^2} c_R^e c_R^\mu g_{\mu\nu} [\bar{\nu}_\downarrow(p_2) \gamma^\mu u_\uparrow(p_1)] [\bar{u}_\uparrow(p_3) \gamma^\nu v_\downarrow(p_4)]$	
$M_{RL} = -\frac{g_Z^2}{q^2 - m_Z^2} c_R^e c_L^\mu g_{\mu\nu} [\bar{\nu}_\downarrow(p_2) \gamma^\mu u_\uparrow(p_1)] [\bar{u}_\downarrow(p_3) \gamma^\nu v_\uparrow(p_4)]$	
$M_{LR} = -\frac{g_Z^2}{q^2 - m_Z^2} c_L^e c_R^\mu g_{\mu\nu} [\bar{\nu}_\uparrow(p_2) \gamma^\mu u_\downarrow(p_1)] [\bar{u}_\uparrow(p_3) \gamma^\nu v_\downarrow(p_4)]$	
$M_{LL} = -\frac{g_Z^2}{q^2 - m_Z^2} c_L^e c_L^\mu g_{\mu\nu} [\bar{\nu}_\uparrow(p_2) \gamma^\mu u_\downarrow(p_1)] [\bar{u}_\downarrow(p_3) \gamma^\nu v_\uparrow(p_4)]$	

Precision Tests- VIII

167

Almost 'Cut & Paste' from QED case:

$$|M_{RR}|^2 = s^2 \left| \frac{g_Z^2}{s - m_Z^2} \right|^2 (c_R^e)^2 (c_R^\mu)^2 (1 + \cos \theta)^2$$

$$|M_{RL}|^2 = s^2 \left| \frac{g_Z^2}{s - m_Z^2} \right|^2 (c_R^e)^2 (c_L^\mu)^2 (1 - \cos \theta)^2$$

$$|M_{LR}|^2 = s^2 \left| \frac{g_Z^2}{s - m_Z^2} \right|^2 (c_L^e)^2 (c_R^\mu)^2 (1 - \cos \theta)^2$$

$$|M_{LR}|^2 = s^2 \left| \frac{g_Z^2}{s - m_Z^2} \right|^2 (c_L^e)^2 (c_L^\mu)^2 (1 + \cos \theta)^2$$

Precision Tests- IX

168

Now take correct Z propagator: Z unstable

$$-i \frac{g_{\mu\nu}}{q^2 - m_Z^2} = -i \frac{g_{\mu\nu}}{s - m_Z^2} \rightarrow -i \frac{g_{\mu\nu}}{s - m_Z^2 + im_Z \Gamma_Z}$$

$$\rightarrow \left| -i \frac{1}{s - m_Z^2 + im_Z \Gamma_Z} \right|^2 = \frac{1}{(s - m_Z^2)^2 + m_Z^2 \Gamma_Z^2}$$

$$\frac{d\sigma}{d\Omega} = \frac{|M_{fi}|^2}{64\pi^2 s}$$

→ Differential cross-section for the 4 combinations:

$$\frac{d\sigma_{RR}}{d\Omega} = \frac{1}{64\pi^2} \frac{g_Z^4 s}{(s - m_Z^2)^2 + m_Z^2 \Gamma_Z^2} (c_R^e)^2 (c_R^\mu)^2 (1 + \cos \theta)^2$$

$$\frac{d\sigma_{LL}}{d\Omega} = \frac{1}{64\pi^2} \frac{g_Z^4 s}{(s - m_Z^2)^2 + m_Z^2 \Gamma_Z^2} (c_L^e)^2 (c_L^\mu)^2 (1 + \cos \theta)^2$$

$$\frac{d\sigma_{LR}}{d\Omega} = \frac{1}{64\pi^2} \frac{g_Z^4 s}{(s - m_Z^2)^2 + m_Z^2 \Gamma_Z^2} (c_L^e)^2 (c_R^\mu)^2 (1 - \cos \theta)^2$$

$$\frac{d\sigma_{RL}}{d\Omega} = \frac{1}{64\pi^2} \frac{g_Z^4 s}{(s - m_Z^2)^2 + m_Z^2 \Gamma_Z^2} (c_L^e)^2 (c_R^\mu)^2 (1 - \cos \theta)^2$$

Precision Tests- X

169

Most interesting difference wrt *QED* case:

$$|M_{LL}|^2 + |M_{RR}|^2 \neq |M_{LR}|^2 + |M_{RL}|^2$$

Unpolarized cross section: Average & Sum over spins

$$\rightarrow \frac{d\sigma}{d\Omega} = \frac{1}{64\pi^2} \frac{1}{4} \frac{g_Z^4 s}{(s - m_Z^2)^2 + m_Z^2 \Gamma_Z^2} \frac{1}{4} (c_V^2 + c_A^2)_e (c_V^2 + c_A^2)_\mu (1 + \cos^2 \theta) + 2(c_V c_A)_e (c_V c_A)_\mu \cos \theta$$

Sizeable forward-backward asymmetry!

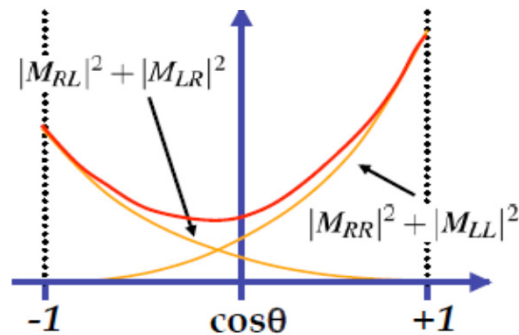

Precision Tests - XI

170

Integrate over solid angle, get total cross section:

$$\sigma_{e^+e^- \rightarrow Z \rightarrow \mu^+\mu^-} = \frac{1}{192\pi} \frac{g_Z^4 s}{(s - m_Z^2)^2 + m_Z^2 \Gamma_Z^2} [(c_V^e)^2 + (c_A^e)^2][(c_V^\mu)^2 + (c_A^\mu)^2]$$

Recall partial Z widths:

$$\Gamma(Z \rightarrow e^+e^-) = \frac{g_Z^2 m_Z}{48\pi} [(c_V^e)^2 + (c_A^e)^2] \quad \Gamma(Z \rightarrow \mu^+\mu^-) = \frac{g_Z^2 m_Z}{48\pi} [(c_V^\mu)^2 + (c_A^\mu)^2]$$

$$\sigma = \frac{12\pi}{m_Z^2} \frac{s}{(s - m_Z^2)^2 + m_Z^2 \Gamma_Z^2} \Gamma(Z \rightarrow e^+e^-) \Gamma(Z \rightarrow \mu^+\mu^-)$$

$$\rightarrow \sigma_{peak} \simeq \frac{12\pi (BR)^2}{m_Z^2} \simeq \frac{37.7 (3.510^{-2})^2}{(91.2)^2} \simeq 55 \cdot 10^{-7} GeV^{-2}$$

$$(\hbar c)^2 \simeq 0.389 GeV^2 mb$$

$$\rightarrow \sigma_{peak} \simeq 55 \cdot 10^{-7} GeV^{-2} \cdot 0.389 GeV^2 mb \simeq 2.1410^{-6} mb = 2.14 nb$$

Precision Tests - XII

171

Z peak: Essentially 4 types of events

$e^+e^- \rightarrow e^+e^-, \mu^+\mu^-, \tau^+\tau^-, q\bar{q} (\rightarrow \text{hadrons})$

Different topologies in the detectors:

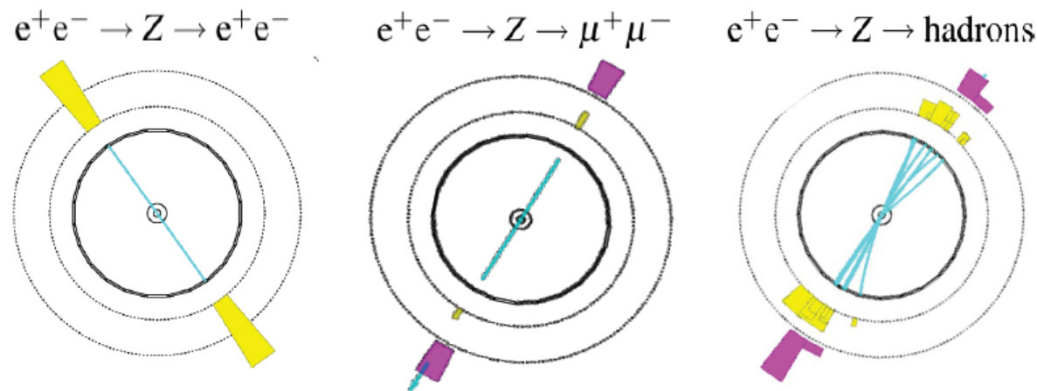

Measuring cross sections:

Count events (!)

Subtract background

Correct for inefficiency

Get integrated luminosity (Most of the time from independent counting of Bhabha events)

$$\rightarrow \sigma = \frac{N - N_{bck}}{\varepsilon} \frac{1}{L_{int}}$$

Precision Tests - XIII

172

Among other results at the peak: Z^0 lineshape

Meaning in practice:

m_Z Z mass

Γ_Z Z total width

Γ_f Z partial width to fermion type f

N_ν Number of (SM) neutrino species

Obtained by 'scanning' the Z^0 peak:

Move $E_{beam} = \frac{\sqrt{s}}{2}$ in steps through the peak

Measure relevant σ at each step

Fit profile:

$$\sigma(e^+e^- \rightarrow Z \rightarrow \bar{f}f) = \frac{12\pi}{m_Z^2} \frac{s\Gamma_{ee}\Gamma_{ff}}{(s - m_Z^2)^2 + m_Z^2\Gamma_Z^2}$$

Precision Tests - XIV

173

Lineshape quite distorted by several effects

Main effect: Initial State Radiation (ISR)

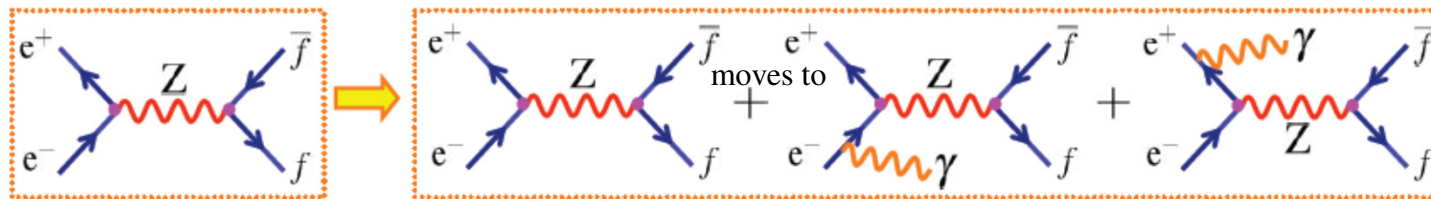

Result:

Collision CM energy $\neq 2E_{beam}$

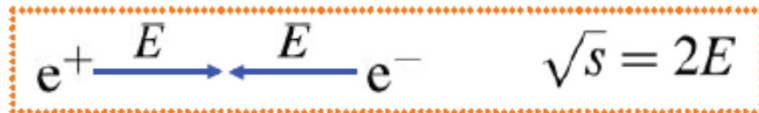

moves to

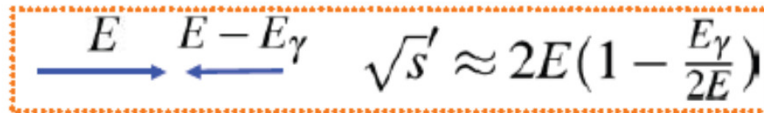

$$m_Z = 91.1875 \pm 0.0021 \text{ GeV}$$

$$\Gamma_Z = 2.4952 \pm 0.0023 \text{ GeV}$$

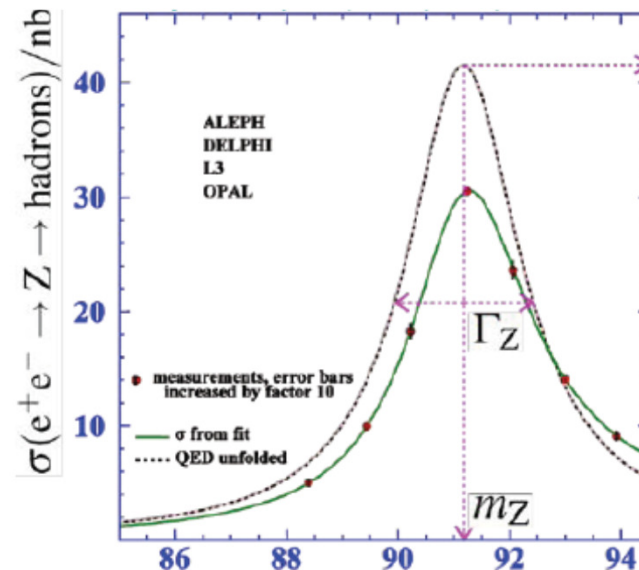

Precision Tests - XV

174

Finding the number of Standard Model neutrinos
(Meaning: With standard coupling to Z)

Total width:

$$\Gamma = \Gamma_{ee} + \Gamma_{\mu\mu} + \Gamma_{\tau\tau} + \Gamma_{had} + \Gamma_{\nu_1\nu_1} + \Gamma_{\nu_2\nu_2} + \Gamma_{\nu_3\nu_3} + ?$$

$$\Gamma = 3\Gamma_{ll} + \Gamma_{had} + N_\nu \Gamma_{\nu\nu}$$

Measure partial widths from peak cross sections:

$$\sigma_0^{ff} = \frac{12\pi}{m_Z^2} \frac{\Gamma_{ee} \Gamma_{ff}}{\Gamma_Z^2}$$

$$N_\nu = 2.9840 \pm 0.0082$$

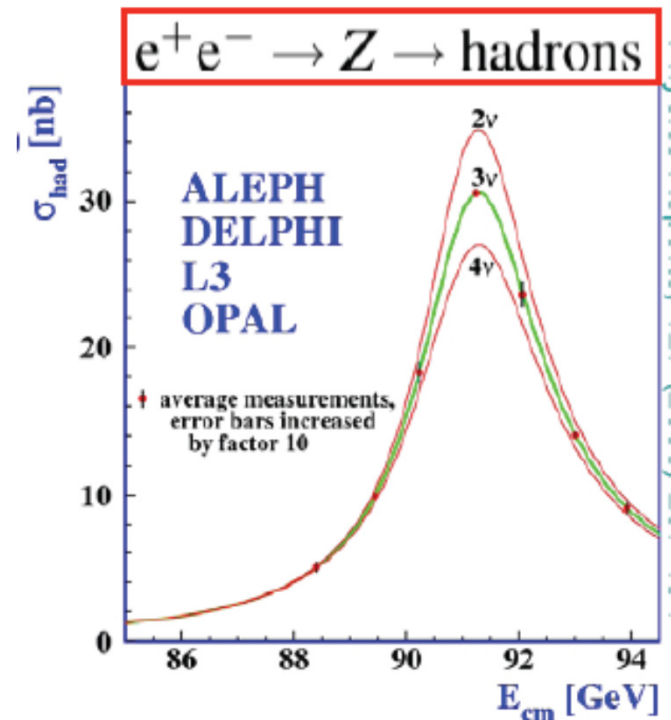

Precision Tests - XVI

175

Write differential cross section (e.g. for $e^+e^- \rightarrow \mu^+\mu^-$) as:

$$\frac{d\sigma}{d\Omega} = k \left[A(1 + \cos^2 \theta) + B \cos \theta \right]$$

$$A = \left[(c_L^e)^2 + (c_R^e)^2 \right] \left[(c_L^\mu)^2 + (c_R^\mu)^2 \right], \quad B = \left[(c_L^e)^2 - (c_R^e)^2 \right] \left[(c_L^\mu)^2 - (c_R^\mu)^2 \right]$$

Forward/Backward cross sections:

$$\sigma_F = \int_0^1 \frac{d\sigma}{d \cos \theta} d \cos \theta, \quad \sigma_B = \int_{-1}^0 \frac{d\sigma}{d \cos \theta} d \cos \theta$$

FB Asymmetry:

$$A_{FB} = \frac{\sigma_F - \sigma_B}{\sigma_F + \sigma_B}$$

$$\sigma_F = k \left(\frac{4}{3} A + \frac{1}{2} B \right), \quad \sigma_B = k \left(\frac{4}{3} A - \frac{1}{2} B \right)$$

$$\rightarrow A_{FB} = \frac{3 B}{8 A} = \frac{3 \left[(c_L^e)^2 - (c_R^e)^2 \right] \left[(c_L^\mu)^2 - (c_R^\mu)^2 \right]}{4 \left[(c_L^e)^2 + (c_R^e)^2 \right] \left[(c_L^\mu)^2 + (c_R^\mu)^2 \right]} = \frac{3}{4} A_e A_\mu$$

Precision Tests - XVII

176

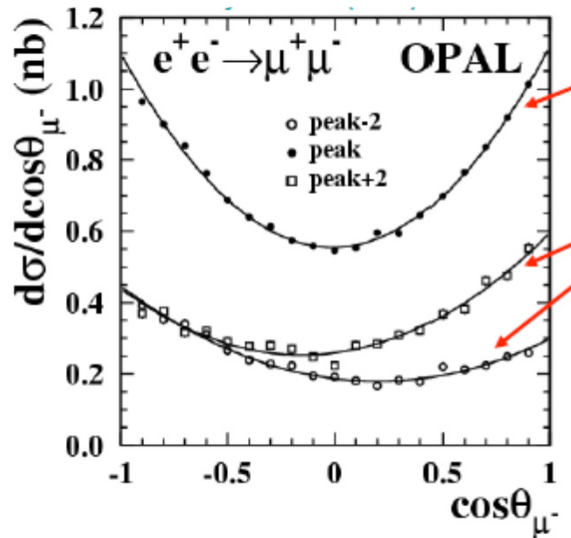

$A_{FB}(peak) \sim 0$ for leptons ($\sin^2\theta_W \approx 0.25$)

$$A_{FB}(peak \pm 2 \text{ GeV}) \neq 0: = 2 \frac{c_V/c_A}{1 + (c_V/c_A)^2}$$

Interference with QED

$$A_{FB}^{0,e} = 0.0145 \pm 0.0025$$

$$A_e = 0.1514 \pm 0.0019$$

$$A_{FB}^{0,\mu} = 0.0169 \pm 0.0013$$

$$A_\mu = 0.1456 \pm 0.0091$$

$$A_{FB}^{0,\tau} = 0.0188 \pm 0.0017$$

$$A_\tau = 0.1449 \pm 0.0040$$

$$\sin^2\theta_W = 0.23154 \pm 0.00016$$

Precision Tests - XVIII

177

LEP2: Study of WW production

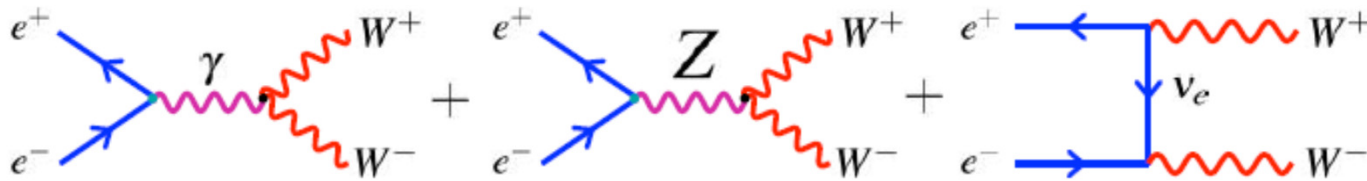

$$Br(W^- \rightarrow \text{hadrons}) \approx 0.67$$

$$Br(W^- \rightarrow e^- \bar{\nu}_e) \approx 0.11$$

$$Br(W^- \rightarrow \mu^- \bar{\nu}_\mu) \approx 0.11$$

$$Br(W^- \rightarrow \tau^- \bar{\nu}_\tau) \approx 0.11$$

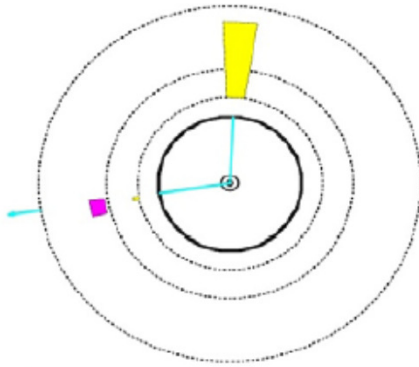

$$W^+W^- \rightarrow l^+ \nu l^- \bar{\nu}$$

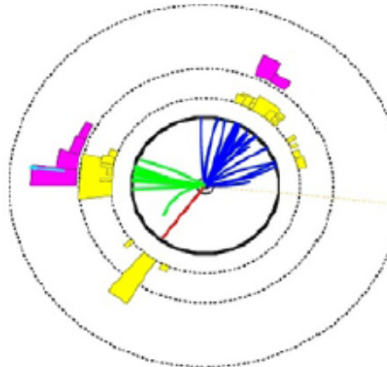

$$W^+W^- \rightarrow q\bar{q}l\nu$$

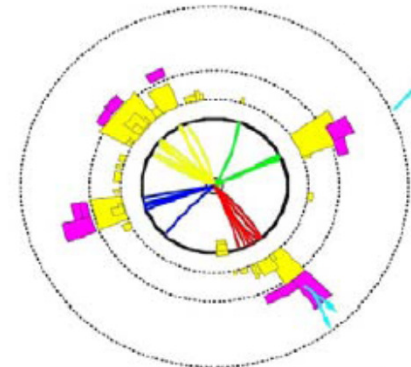

$$W^+W^- \rightarrow q\bar{q}q\bar{q}$$

Precision Tests - XIX

178

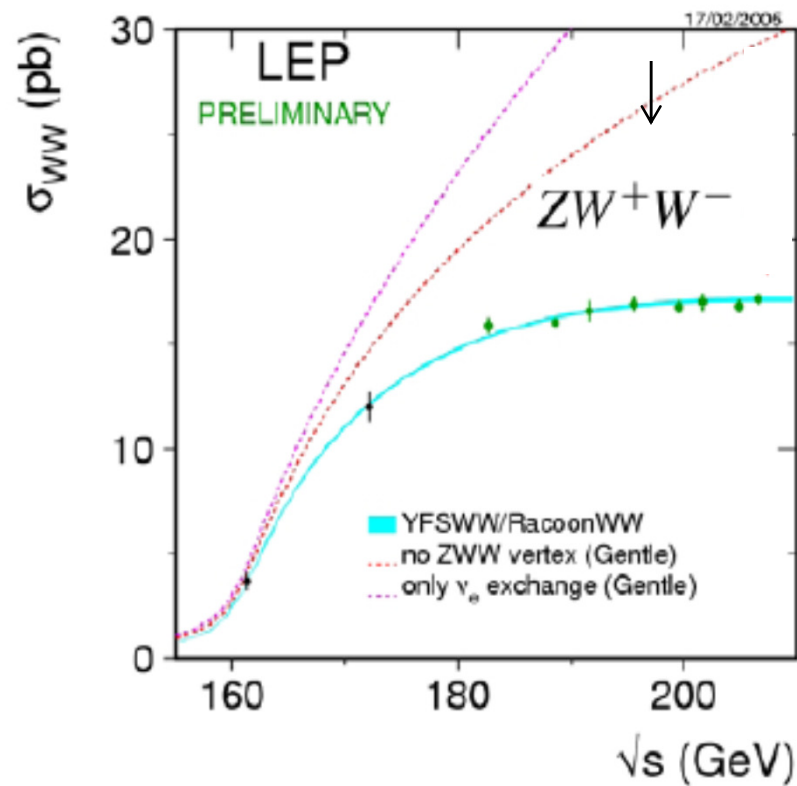

Maybe one of the best results of the whole LEP saga

Precision Tests - XX

179

Measurement of m_W : Kinematical fit

Example:

$$W^+W^- \rightarrow q\bar{q}e^-\bar{\nu}$$

Get $\bar{\nu}$ 4-momentum from:

$$p_q + p_{\bar{q}} + p_{e^-} + p_{\bar{\nu}} = (\sqrt{s}, 0)$$

Make W bosons masses :

$$M_{W^+} = (p_q + p_{\bar{q}})^2$$

$$M_{W^-} = (p_{e^-} + p_{\bar{\nu}})^2$$

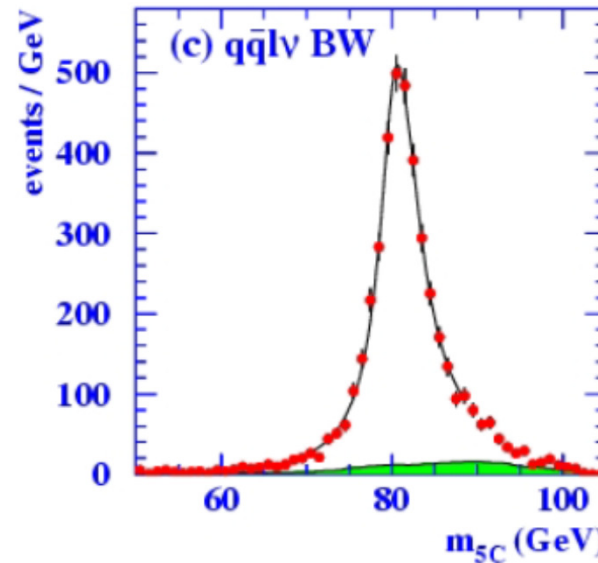

$$m_W = 80.376 \pm 0.033 \text{ GeV}$$

$$\Gamma_W = 2.196 \pm 0.083 \text{ GeV}$$

Loopology - I

180

Standard Model :

$$M_W = M_Z \cos \theta_W$$

$$\text{Measure: } \begin{cases} M_Z = 91.1875 \pm 0.0021 \text{ GeV} \\ \sin^2 \theta_W = 0.23154 \pm 0.00016 \end{cases}$$

→ Predict $M_W = 79.946 \pm 0.008 \text{ GeV}$

Measure

$$M_W = 80.376 \pm 0.033 \text{ GeV}$$

Discrepancy: Virtual loops (including Higgs..)

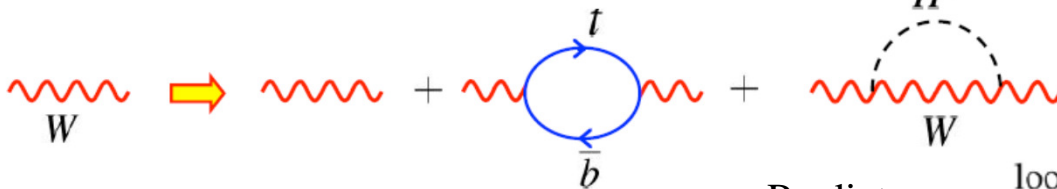

$$m_W = m_W^0 + a m_t^2 + b \ln \left(\frac{m_H}{m_W} \right)$$

$$\text{Predict: } m_t^{\text{loop}} = 173 \pm 11 \text{ GeV}$$

$$\text{Observe: } m_t^{\text{meas}} = 174.2 \pm 3.3 \text{ GeV}$$

!!!

Loopology - II

181

Applied loopology:

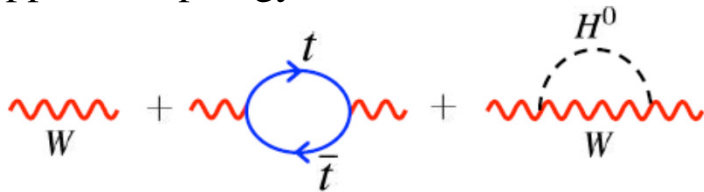

$$m_W = m_W^0 + am_t^2 + b \ln \left(\frac{m_H}{m_W} \right)$$

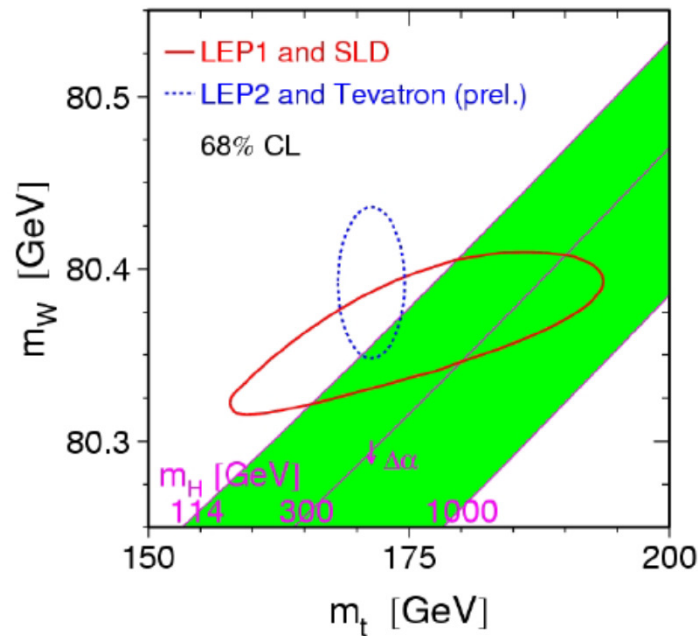

$$m_H < 200 \text{ GeV}$$

The Happy End

182

All is well that ends well:
And finally...

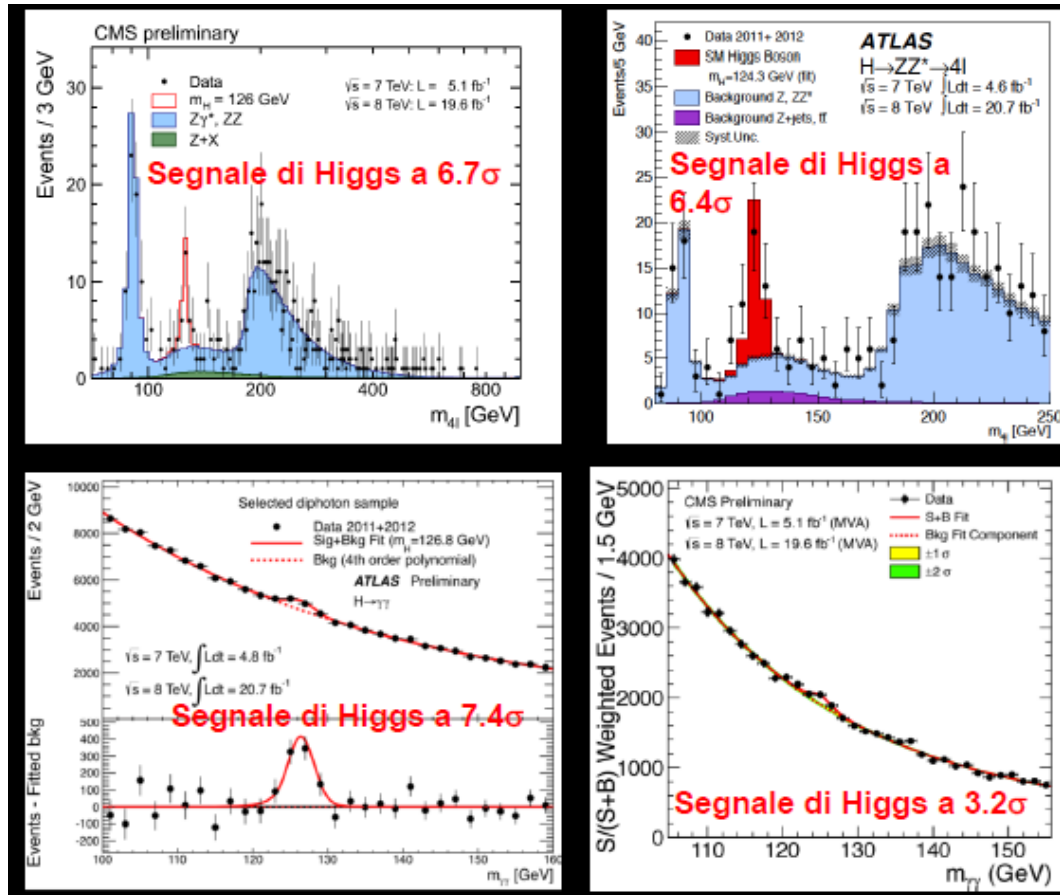

... Mr. Higgs
and Mr. Englert
went to Stockholm