

21 - MOS

Giunzione Metallo – Ossido (=isolante) – Semiconduttore :

Realizzata sotto forma di *condensatore MOS*

Situazione all'equilibrio:

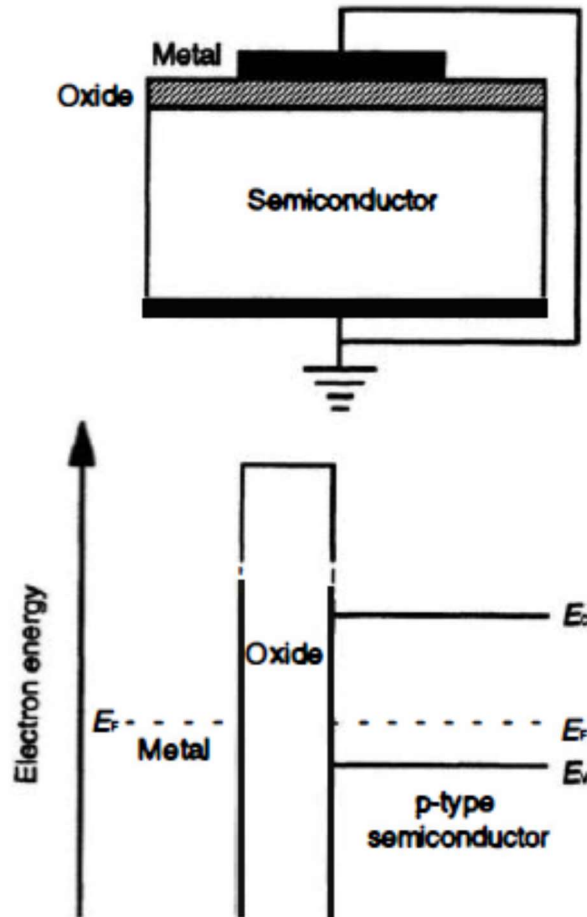

Gap nell'ossido $\sim 10 \text{ eV} \gg$ Gap nel semiconduttore

Situazione all'equilibrio:

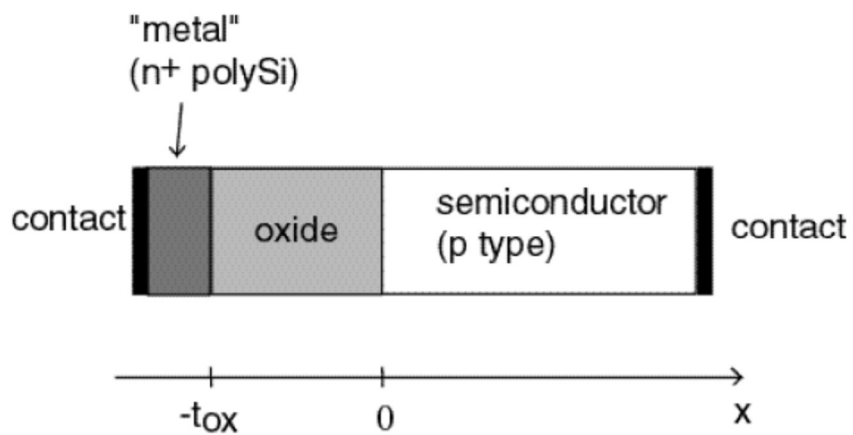

Contatto ohmico fra M e S

→ Trasferimento di elettroni $M \rightarrow S$, lacune $S \rightarrow M$

→ Carica spaziale

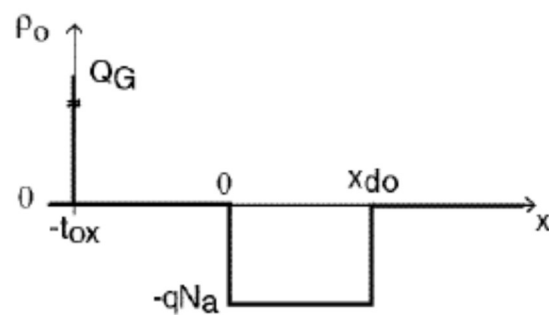
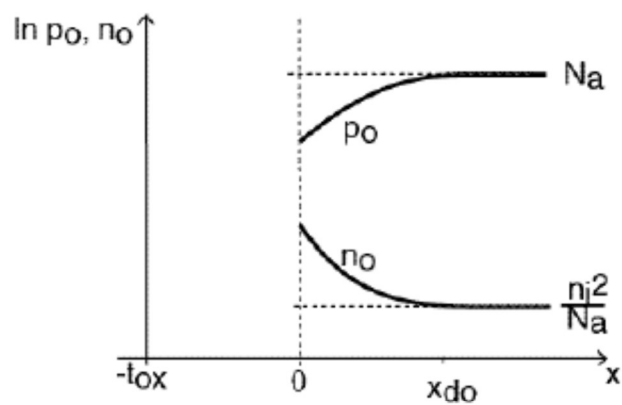

$$\sigma = Q_G \quad x = -t_{ox} \quad \text{carica superficiale sul metallo}$$

$$\rho_0(x) = 0 \quad -t_{ox} < x < 0$$

$$\rho_0(x) = -qN_A \quad 0 < x < x_{d0}$$

$$\rho_0(x) = 0 \quad x > x_{d0}$$

$$E_0(x_2) - E_0(x_1) = \frac{1}{\epsilon} \int_{x_1}^{x_2} \rho_0(x') dx' \quad \text{c. elettrico}$$

$$\epsilon_{ox} E_{ox} = \epsilon_s E_s \quad \text{cons. componente normale di } \mathbf{E} \text{ fra due mezzi}$$

$$\rightarrow \frac{E_{ox}}{E_s} = \frac{\epsilon_s}{\epsilon_{ox}} \approx 3$$

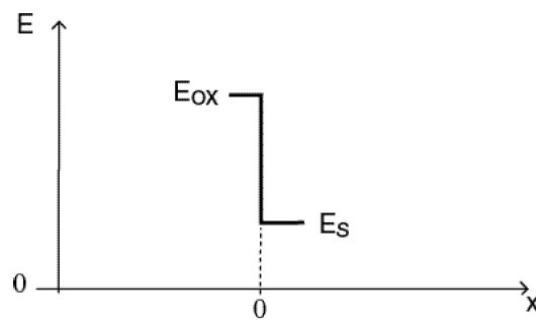

→ C. elettrico vs x:

$$E_0(x) = 0 \quad x < -t_{ox}$$

$$E_0(x) = \frac{\epsilon_s}{\epsilon_{ox}} E_0(x=0^+) = \frac{qN_A x_{d0}}{\epsilon_{ox}} \quad -t_{ox} < x < 0$$

$$E_0(x) - E_0(x_{d0}) = \frac{1}{\epsilon_s} \int_{x_{d0}}^x (-qN_A) dx' = -\frac{qN_A}{\epsilon_s} (x - x_{d0}) \quad 0 < x < x_{d0}$$

$$E_0(x) = 0 \quad x > x_{d0}$$

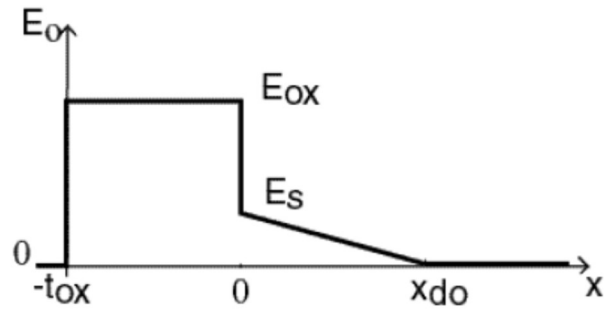

Valori limite del potenziale nel metallo e nel semiconduttore:

$$\phi = \frac{kT}{q} \ln \frac{n_0}{n_i} \quad \text{metallo}$$

$$n_0 = N_D^+ \rightarrow \phi_{n^+} = \phi_G = \frac{kT}{q} \ln \frac{N_D^+}{n_i}$$

$$\phi = -\frac{kT}{q} \ln \frac{p_0}{n_i} \quad \text{semiconduttore}$$

$$p_0 = N_A \rightarrow \phi_p = -\frac{kT}{q} \ln \frac{N_A}{n_i}$$

$$\rightarrow \phi_G - \phi_p = \phi_{n^+} + \frac{kT}{q} \ln \frac{N_A}{n_i} \equiv \phi_{bi} \quad (\equiv \phi_B \text{ nei grafici})$$

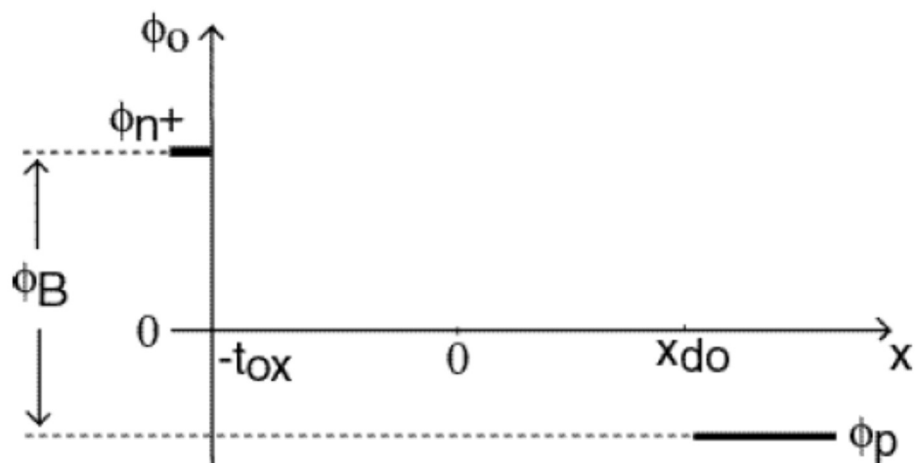

$$\phi_0(x) = \phi_{n^+}$$

$$x < -t_{ox}$$

$$\phi_0(x) = \phi_p + \frac{qN_A}{2\epsilon_s} x_{d0}^2 + \frac{qN_A x_{d0}}{\epsilon_{ox}} (-x)$$

$$-t_{ox} < x < 0$$

$$\phi_0(x) - \phi_0(x_{d0}) = - \int_{x_{d0}}^x - \frac{qN_A}{\epsilon_s} (x' - x_{d0}) dx'$$

$$\rightarrow \phi_0(x) = \phi_p + \frac{qN_A}{2\epsilon_s} (x - x_{d0})^2$$

$$0 < x < x_{d0}$$

$$\phi_0(x) = \phi_p$$

$$x > x_{d0}$$

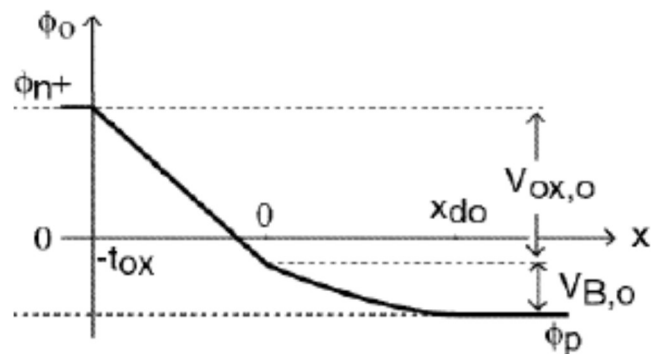
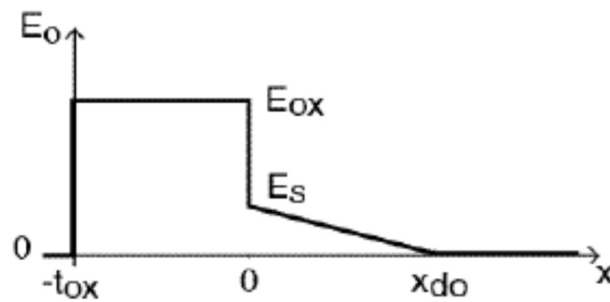

Per determinare x_{0d} :

$$\rightarrow \phi_B = V_{sc} + V_{ox} = \frac{qN_A x_{0d}^2}{2\epsilon_s} + \frac{qN_A t_{ox} x_{0d}}{\epsilon_{ox}}$$

$$\rightarrow x_{0d} = \frac{\epsilon_s}{\epsilon_{ox}} t_{ox} \left(\sqrt{1 + \frac{2\epsilon_{ox}^2 \phi_B}{q\epsilon_s N_A t_{ox}^2}} - 1 \right)$$

Definendo

$$C_{ox} = \frac{\epsilon_{ox}}{t_{ox}} \quad \text{capacita'/unita' di superficie}$$

$$\rightarrow x_{0d} = \frac{\epsilon_s}{C_{ox}} \left(\sqrt{1 + \frac{2C_{ox}^2 \phi_B}{q\epsilon_s N_A}} - 1 \right)$$

