

Da proprietà elementari TdL:

$$x(t) \stackrel{L}{\leftrightarrow} X(s)$$

$$\frac{dx}{dt} \stackrel{L}{\leftrightarrow} sX(s)$$

$$\int_0^t x(t') dt' \stackrel{L}{\leftrightarrow} \frac{1}{s} X(s)$$

→ Impedenze generalizzate di L e C :

$$V_C(s) = Z_C(s) I_C(s) = \frac{1}{sC} I(s)$$

$$V_L(s) = Z_L(s) I_L(s) = sLI(s)$$

→ Derivatore e Integratore ideali

Circuiti pratici: Approssimazioni

Circuiti con 1 elemento reattivo: I ordine

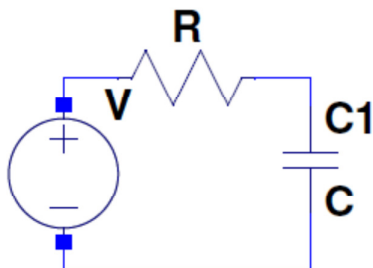

I: Derivata approx di V
VC: Integrale approx di V
VR: Derivata approx di V

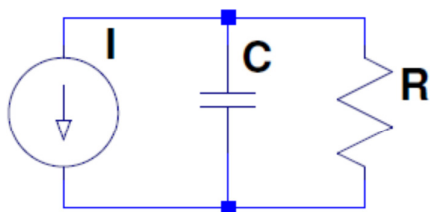

V: Integrale approx di I
IR: Integrale approx di I
IC: derivata approx di I

Per brevità, solo circuito RC serie: altri (RC parallelo, RL serie e parallelo) del tutto simili. Grafici rilevanti: v. lezione precedente su trattamento 'euristico'

Risposta al gradino:

$$v_{in}(t) = V_0 H(t) \rightarrow V_{in}(s) = \frac{V_0}{s}$$

Variabile di uscita: tensione su C

TdL:

$$V_{out}(s) = V_{in}(s) \frac{\frac{1}{sC}}{\frac{1}{sC} + R} = \frac{V_0}{s} \frac{1}{1 + sCR} = V_0 \left(\frac{A}{s} + \frac{B}{1 + sCR} \right)$$

$$\frac{A(1 + sCR) + Bs}{s(1 + sCR)} = \frac{s(ACR + B) + A}{s(1 + sCR)} = \frac{1}{s(1 + sCR)}$$

$$\rightarrow A = 1, A = -\frac{B}{CR} \rightarrow B = -CR$$

$$\rightarrow V_{out}(s) = V_0 \left(\frac{1}{s} - \frac{CR}{1 + sCR} \right) = V_0 \left(\frac{1}{s} - \frac{1}{\frac{1}{RC} + s} \right)$$

Anti-TdL:

$$\rightarrow v_{out}(t) = V_0 \left(H(t) - e^{-\frac{t}{CR}} \right)$$

Come atteso:

$$t \ll RC \rightarrow v_{out}(t) \approx V_0 \frac{t}{RC} \quad \text{Integrale approx di } v_{in}(t)$$

Risposta alla δ :

$$v_{in}(t) = V_0 \delta(t) \rightarrow V_{in}(s) = V_0$$

TdL:

$$V_{out}(s) = V_{in}(s) \frac{\frac{1}{sC}}{\frac{1}{sC} + R} = V_0 \frac{1}{1 + sCR}$$

Anti-TdL:

$$\rightarrow v_{out}(t) = V_0 e^{-\frac{t}{CR}}$$

Come atteso:

$$t \ll RC \rightarrow v_{out}(t) \approx V_0 \quad \text{Integrale approx di } v_{in}(t)$$

Risposta al gradino:

$$v_{in}(t) = V_0 H(t) \rightarrow V_{in}(s) = \frac{V_0}{s}$$

Variabile di uscita: tensione su R

TdL:

$$V_{out}(s) = V_{in}(s) \frac{R}{\frac{1}{sC} + R} = \frac{V_0}{s} \frac{sRC}{1 + sCR} = V_0 \left(\frac{RC}{1 + sCR} \right) = V_0 RC \frac{1}{1 + sCR}$$

Anti-TdL:

$$\rightarrow v_{out}(t) = V_0 e^{-\frac{t}{CR}}$$

Come atteso:

$$t \gg RC \rightarrow v_{out}(t) \approx 0 \text{ Derivata approx di } v_{in}(t)$$

Risposta alla δ :

$$v_{in}(t) = V_0 \delta(t) \rightarrow V_{in}(s) = V_0$$

TdL:

$$V_{out}(s) = V_{in}(s) \frac{R}{\frac{1}{sC} + R} = V_0 \frac{sCR}{1 + sCR} = V_0 \left(1 - \frac{1}{1 + sCR} \right)$$

Anti-TdL:

$$\rightarrow v_{out}(t) = V_0 \left(\delta(t) - e^{-\frac{t}{CR}} \right)$$

Come atteso:

$$t \gg RC \rightarrow v_{out}(t) \approx 0 \text{ Derivata approx di } v_{in}(t)$$

NB Derivata di $\delta(t)$?? \rightarrow 'Doppietto di Dirac'

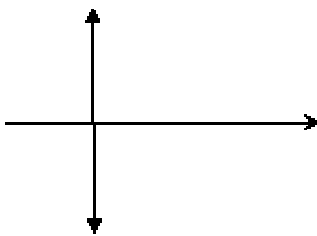

Moltiplicata per una funzione $x(t)$ e integrata produce $\frac{dx}{dt} \Big|_{t=0}$:

$$\int_{-\infty}^{+\infty} \delta'(t) x(t) dt = x(t) \delta(t) \Big|_{-\infty}^{+\infty} - \int_{-\infty}^{+\infty} \delta(t) \frac{dx}{dt} dt = \frac{dx}{dt} \Big|_{t=0}$$

Risposta a impulso rettangolare: Ampiezza V_0 , larghezza T

$$v_{in}(t) = V_0 [H(t) - H(t-T)] \rightarrow V_{in}(s) = \frac{V_0}{s} - \frac{V_0}{s} e^{-sT}$$

Variabile di uscita: tensione su R

TdL:

$$V_{out}(s) = V_{in}(s) \frac{R}{\frac{1}{sC} + R} = \frac{V_0}{s} (1 - e^{-sT}) \frac{sRC}{1 + sCR} = V_0 (1 - e^{-sT}) \left(\frac{RC}{1 + sCR} \right)$$

$$= V_0 \frac{RC}{1 + sCR} - V_0 \frac{RC}{1 + sCR} e^{-sT}$$

Anti-TdL:

$$\rightarrow v_{out}(t) = V_0 \left(e^{-\frac{t}{CR}} - e^{-\frac{t-T}{CR}} H(t-T) \right)$$

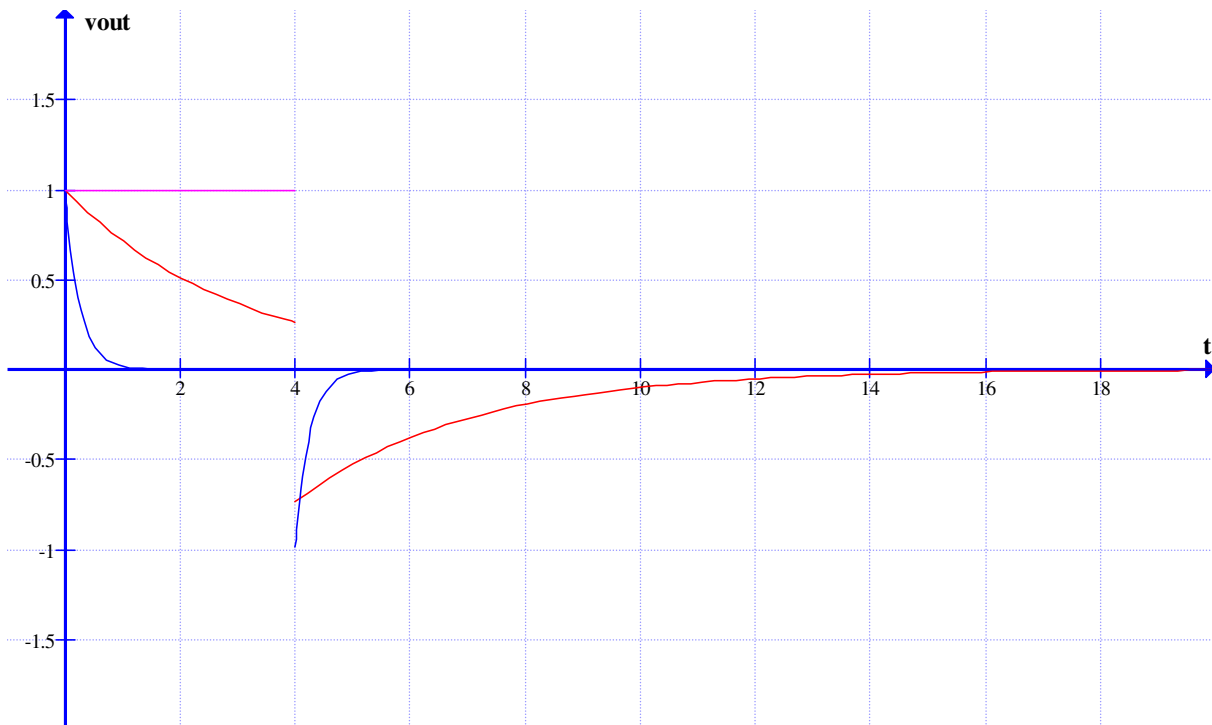

Risposta a impulso rettangolare: Ampiezza V_0 , larghezza T

$$v_{in}(t) = V_0 [H(t) - H(t-T)] \rightarrow V_{in}(s) = \frac{V_0}{s} - \frac{V_0}{s} e^{-sT}$$

Variabile di uscita: tensione su C

TdL:

$$V_{out}(s) = V_{in}(s) \frac{\frac{1}{sC}}{\frac{1}{sC} + R} = \frac{V_0}{s} (1 - e^{-sT}) \frac{1}{1 + sCR}$$
$$= \frac{V_0}{s} \frac{1}{1 + sCR} - \frac{V_0}{s} \frac{1}{1 + sCR} e^{-sT}$$

Anti-TdL:

$$\rightarrow v_{out}(t) = V_0 \left[1 - e^{-\frac{t}{CR}} - H(t-T) \left(1 - e^{-\frac{t-T}{CR}} \right) \right]$$

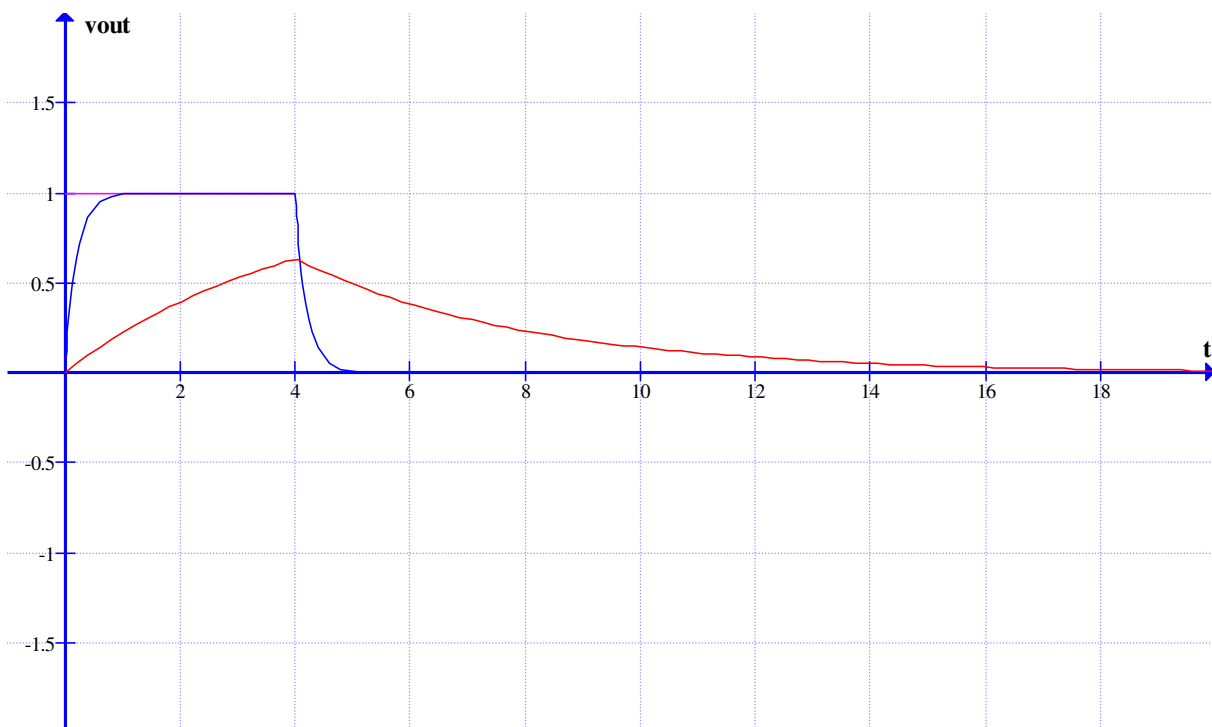

Circuito oscillante: risposta al gradino

2 elementi reattivi: circuito del II ordine

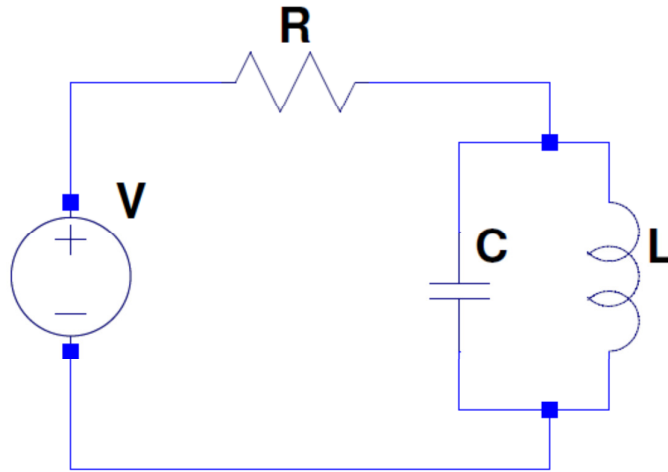

$$Z(s) = R + Z_{\parallel}(s)$$

$$Z_{\parallel}(s) = \frac{sL \frac{1}{sC}}{sL + \frac{1}{sC}} = \frac{\frac{L}{C}}{sL + \frac{1}{sC}} = \frac{sL}{s^2 LC + 1}$$

$$\rightarrow Z(s) = R + \frac{sL}{s^2 LC + 1}$$

$$\rightarrow V_{out}(s) = V_{in}(s) \frac{\frac{sL}{s^2 LC + 1}}{R + \frac{sL}{s^2 LC + 1}} = V_{in}(s) \frac{sL}{R(s^2 LC + 1) + sL}$$

$$V_{in}(s) = \frac{V_0}{s} \rightarrow V_{out}(s) = V_0 \frac{L}{RLC \left(s^2 + \frac{1}{LC} + \frac{s}{RC} \right)} = V_0 \frac{1}{RC \left(s^2 + \frac{s}{RC} + \frac{1}{LC} \right)}$$

$$\omega_0 \equiv \frac{1}{\sqrt{LC}}, K \equiv \frac{1}{2R} \sqrt{\frac{L}{C}} \rightarrow 2K\omega_0 = \frac{1}{RC}$$

$$\rightarrow V_{out}(s) = V_0 \frac{1}{RC \left(s^2 + \frac{s}{RC} + \frac{1}{LC} \right)} = 2V_0 K \omega_0 \frac{1}{s^2 + 2K\omega_0 s + \omega_0^2}$$

Radici del denominatore:

$$s_{\pm} = -K\omega_0 \pm \sqrt{K^2\omega_0^2 - \omega_0^2} = -\omega_0 K \pm \omega_0 \sqrt{K^2 - 1}$$

a) $K = 1$ Smorzamento critico

$$s_+ = s_- = -\omega_0$$

$$\rightarrow V_{out}(s) = 2V_0\omega_0 \frac{1}{(s + \omega_0)^2}$$

$$\rightarrow v_{out}(t) = 2V_0\omega_0 t e^{-\omega_0 t}$$

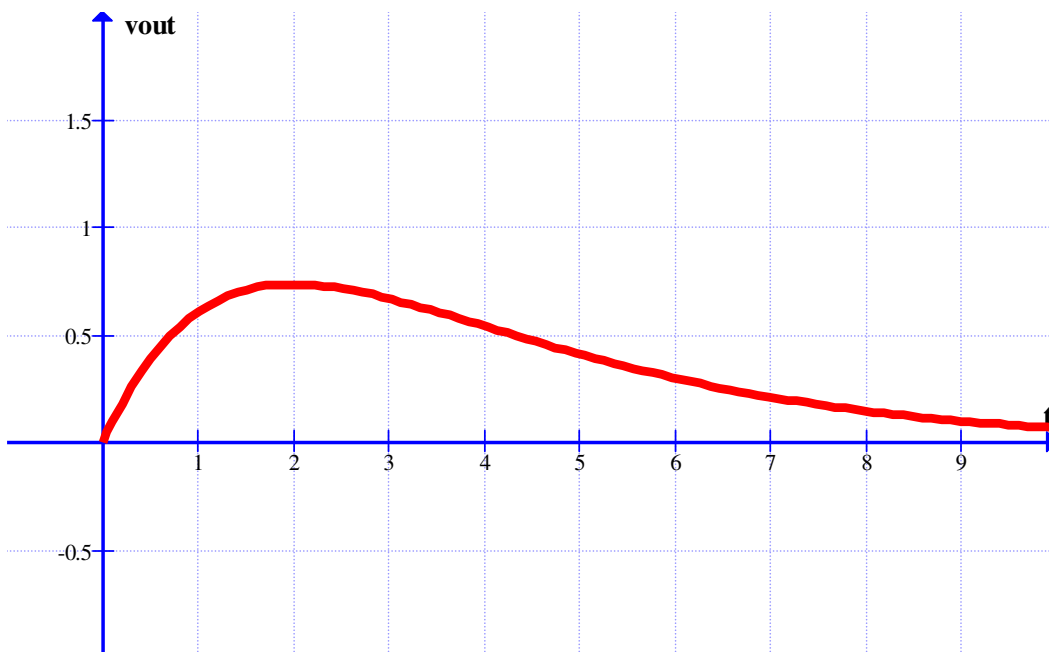

b) $K > 1$ Smorzamento

$$s_{\pm} = -K\omega_0 \pm \sqrt{K^2\omega_0^2 - \omega_0^2} = -\omega_0 \left(K \pm \sqrt{K^2 - 1} \right)$$

$$\rightarrow V_{out}(s) = 2V_0\omega_0 \frac{1}{\left[s + \omega_0 \left(K + \sqrt{K^2 - 1} \right) \right] \left[s + \omega_0 \left(K - \sqrt{K^2 - 1} \right) \right]}$$

$$\frac{1}{\left[s + \omega_0 \left(K + \sqrt{K^2 - 1} \right) \right] \left[s + \omega_0 \left(K - \sqrt{K^2 - 1} \right) \right]} = \frac{A}{s + \omega_0 \left(K + \sqrt{K^2 - 1} \right)} + \frac{B}{s + \omega_0 \left(K - \sqrt{K^2 - 1} \right)}$$

$$A + B = 0 \rightarrow B = -A$$

$$A\omega_0 \left(K - \sqrt{K^2 - 1} \right) + B\omega_0 \left(K + \sqrt{K^2 - 1} \right) = 1$$

$$\rightarrow A\omega_0 \left[K - \sqrt{K^2 - 1} - K - \sqrt{K^2 - 1} \right] = 1 \rightarrow A = -\frac{2\sqrt{K^2 - 1}}{\omega_0}$$

$$\rightarrow V_{out}(s) = 2V_0\omega_0 \frac{-\frac{2\sqrt{K^2 - 1}}{\omega_0}}{s + \omega_0 \left(K + \sqrt{K^2 - 1} \right)} + 2V_0\omega_0 \frac{\frac{2\sqrt{K^2 - 1}}{\omega_0}}{s + \omega_0 \left(K - \sqrt{K^2 - 1} \right)}$$

$$\rightarrow V_{out}(s) = 4V_0\sqrt{K^2 - 1} \left[\frac{1}{s + \omega_0 \left(K - \sqrt{K^2 - 1} \right)} - \frac{1}{s + \omega_0 \left(K + \sqrt{K^2 - 1} \right)} \right]$$

$$\rightarrow v_{out}(t) = 4V_0\sqrt{K^2 - 1} \left[e^{-\omega_0 \left(K - \sqrt{K^2 - 1} \right) t} - e^{-\omega_0 \left(K + \sqrt{K^2 - 1} \right) t} \right]$$

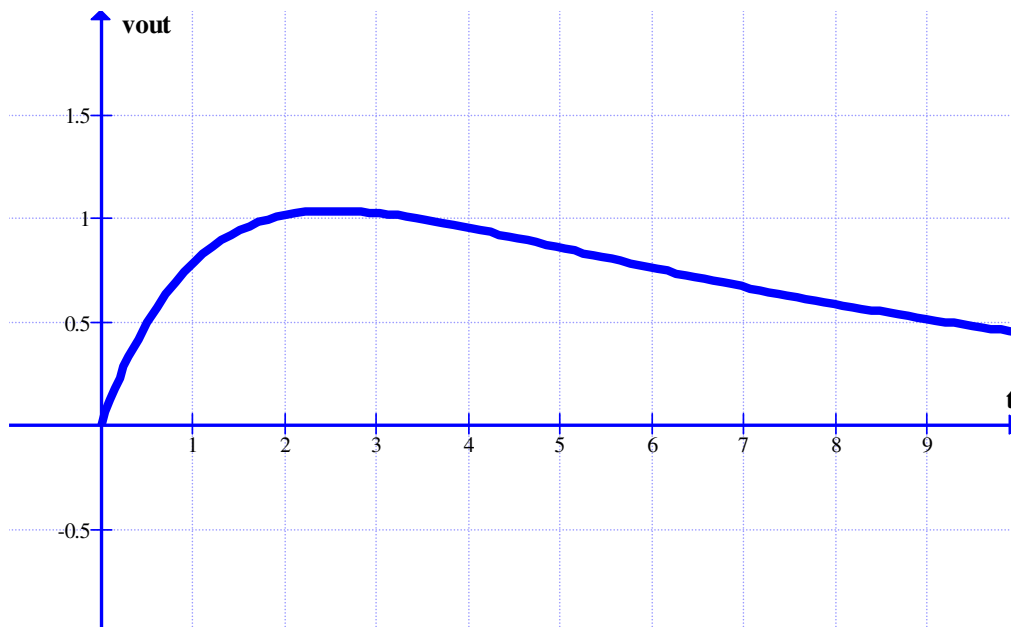

c) $K < 1$ Oscillazioni smorzate

$$s_{\pm} = -K\omega_0 \pm \sqrt{K^2\omega_0^2 - \omega_0^2} = -\omega_0 \left(K \pm i\sqrt{1-K^2} \right)$$

$$\rightarrow V_{out}(s) = 2V_0\omega_0 \frac{1}{\left[s + \omega_0 \left(K + i\sqrt{1-K^2} \right) \right] \left[s + \omega_0 \left(K - i\sqrt{1-K^2} \right) \right]}$$

$$\frac{1}{\left[s + \omega_0 \left(K + i\sqrt{1-K^2} \right) \right] \left[s + \omega_0 \left(K - i\sqrt{1-K^2} \right) \right]} = \frac{A}{s + \omega_0 \left(K + i\sqrt{1-K^2} \right)} + \frac{B}{s + \omega_0 \left(K - i\sqrt{1-K^2} \right)}$$

$$A + B = 0 \rightarrow B = -A$$

$$A\omega_0 \left(K - i\sqrt{1-K^2} \right) + B\omega_0 \left(K + i\sqrt{1-K^2} \right) = 1$$

$$\rightarrow A\omega_0 \left[K - i\sqrt{1-K^2} - K - i\sqrt{1-K^2} \right] = 1 \rightarrow A = -\frac{2i\sqrt{1-K^2}}{\omega_0}$$

$$\rightarrow V_{out}(s) = 2V_0\omega_0 \frac{\frac{2i\sqrt{1-K^2}}{\omega_0}}{s + \omega_0 \left(K + i\sqrt{1-K^2} \right)} + 2V_0\omega_0 \frac{\frac{2i\sqrt{1-K^2}}{\omega_0}}{s + \omega_0 \left(K - i\sqrt{1-K^2} \right)}$$

$$\rightarrow V_{out}(s) = 4V_0i\sqrt{1-K^2} \left[\frac{1}{s + \omega_0 \left(K - i\sqrt{1-K^2} \right)} - \frac{1}{s + \omega_0 \left(K + i\sqrt{1-K^2} \right)} \right]$$

$$\rightarrow v_{out}(t) = 4V_0i\sqrt{1-K^2} \left[e^{-\omega_0 \left(K - i\sqrt{1-K^2} \right) t} - e^{-\omega_0 \left(K + i\sqrt{1-K^2} \right) t} \right] = 8V_0\sqrt{1-K^2} e^{-\omega_0 K t} \sin \left(\sqrt{1-K^2} \omega_0 t \right)$$

